



Motorcycle Applications 2010



www.ngkntk.co.uk



Bikers won't fit anything else



Around the world bikers and bike manufacturers agree that when it comes to spark plugs, one plug is king. NGK. Which is why they are the world's No.1 OE fitment. So don't try fitting anything else.

You have been warned.

Original Equipment suppliers to:- Aprilia Armstrong BMW CCM Cagiva Derbi Ducati Gas Gas Honda Husqvarna India Kawasaki KTM Moto Guzzi Norton Peugeot Polaris Royal Enfield Scorpa Suzuki SMC TGB Triumph Victory Yamaha

CONTENTS

SPARK PLUG APPLICATIONS

Spark Plug Design _____	2	The Iridium IX Spark Plug _____	7
NGK's Copper Core Technology _____	3	Spark Plug Installation Tips _____	8
The Best Spark Plug for every occasion _____	4	Torque Tightening Chart _____	8
Fitting the Correct Spark Plug _____	5	Design Symbols _____	9
The Iridium IX Spark Plug _____	6	New Additions and Part Numbers _____	10-11

2 Wheel

Adly _____	12	Honda _____	24-29
AJS _____	12	Husaberg _____	29
Aprilia _____	12-13	Husqvarna _____	29-30
Atala _____	13	Hyosung _____	30
Bajaj _____	14	Indian _____	31
Baotian _____	14	Italjet _____	31
Barossa _____	14	Jawa-CZ _____	31
Bashan _____	14	Jialing _____	31
Batavus _____	14	Jianshe _____	31
Benelli _____	14	Jinlun _____	31-32
Beta/Betamotor _____	15-16	Kawasaki _____	32-35
Bimota _____	16	Kreidler _____	35
BMW _____	16-17	KTM _____	35-37
BSA _____	17	Kymco _____	37-38
Buell _____	17-18	Lambretta _____	38
Cagiva _____	18	Laverda _____	38
CCM (Armstrong-CCM) _____	19	LEM _____	38
Cossack _____	19	Magni _____	38
CPI _____	19	Maico _____	38
Daelim _____	20	Malaguti _____	38-39
Derbi _____	20	MBK _____	39
Ducati _____	20-22	Montesa _____	39
Fantic _____	22	Moto Guzzi _____	39-40
Gas Gas _____	22-23	Moto Hispania _____	40
Generic _____	23	Moto Morini _____	40
Gilera _____	23-24	Moto Roma _____	40-41
Harley Davidson _____	24	Motobecane _____	41
Hero-Puch _____	24	MS _____	41
Hesketh _____	24	MV Augusta _____	41

MZ _____	41	VOR _____	51
Neval _____	42	Wuyang _____	51
Norton _____	42	Yamaha _____	52-56
Peugeot _____	42		
PGO _____	43		
Piaggio/Vespa _____	43-44		
Puch _____	44		
Regal Raptor _____	44		
Regent _____	44		
Rieju _____	44		
Rovigo _____	44		
Royal Enfield (1980→) _____	45		
RTX _____	45		
Sachs _____	45		
Scorpa _____	45		
Sherco _____	45		
Simson _____	45		
Sinnis _____	45		
SMC _____	46		
Suzuki _____	46-49		
SWM _____	49		
SYM _____	49-50		
TGB _____	50		
Tomos _____	50		
Triumph - Pre 1989 _____	50		
Triumph - 1991 ON _____	50-51		
Uralmoto _____	51		
Vertemati _____	51		
Victory (Polaris) _____	51		



ATV Quad

Apache _____	57
Artic Cat _____	57
Blast (LEM) _____	57
Bombardier _____	57
CPI _____	58
Dinli _____	58
E-Ton _____	58
Gas Gas _____	58
Honda _____	58
Hyosung _____	58
Kawaski _____	59
KTM _____	59
Kymco _____	59
LEM _____	59
Masai _____	59
Massey Ferguson _____	59
Moto Roma _____	60
Polaris _____	60
Quadzilla _____	60
Suzuki _____	61
Sym _____	61
TGB _____	61
Yamaha _____	61-62

SPARK PLUG TECHNICAL INFORMATION

Conversion Chart _____	63-84
Cover Symbols Explanation Chart _____	87
NGK Resistor Plug Covers _____	87
Spark Plug Covers _____	88-89

LAMBDA SENSORS

NTK Lambda Sensors for Motorcycles _____	90
Technical Information _____	90
Aprilia _____	91
BMW _____	91
Ducati _____	91
Honda _____	92
KTM _____	92
Moto Guzzi _____	92
Suzuki _____	92
Triumph _____	92
Connector Types _____	93

This catalogue lists only vehicles officially imported or manufactured in the UK and is effective from November 2009 and supersedes all previous catalogues. Whilst every care is taken in compiling these lists of applications, they are given for general guidance only, and they do not constitute any contractual term, representation or warranty and as such NGK do not accept any responsibility in respect of any claim whatsoever and howsoever caused arising from the publication of this catalogue.

The appropriate NGK Spark Plugs are designed solely for use in automotive, motorcycle, marine, horticultural, agricultural, commercial, industrial, and all stationary engines.

NGK Spark Plugs should not be used in aircraft engines.

Resistor plugs should always be used where they are recommended by the manufacturers. The use of non-resistor plugs, could, in some cases, result in damage to electronic components.

Vitius nemo sine nascitur

SPARK PLUG DESIGN

SPARK PLUG DESIGN

Every year the range of NGK spark plugs grows to accommodate the ever increasing demands of modern engines. Spark plug design must take into consideration many features of an engine including physical dimensions, combustion chamber shape, cooling abilities, fuel and ignition systems. Spark plugs play a vital role in producing the maximum power from an engine whilst keeping fuel consumption and emissions to a minimum. Choosing the correct spark plug type will help a vehicle manufacturer meet legislated emission targets and assists the motorist in getting the best from their engine.

Increases in the size and the requirement to improve the cooling of the inlet and exhaust valves have meant that the space available for the spark plug is severely restricted on some cylinder heads. A change in spark plug design, possibly the adoption of a taper seat and extended reach (threaded portion) or even the use of a smaller diameter is often the answer. Some engines require the use of two spark plugs per cylinder and again due to space restrictions these might be of different sizes.

Changes in fuelling systems and the fuel itself have meant some special features being adopted at the 'firing end' of the spark plug. Extra projected types push the spark position into the heart of the combustion chamber to promote better combustion of the fuel/air mixture, which is weaker than ever in an effort to improve economy. Modern engines manufacturers often require increased spark gaps to allow a longer spark duration, which again aids more efficient combustion.

To combat the 'cold fouling' effect that can occur in some engines using unleaded fuels specially arranged ground electrodes are sometimes used. These can force the spark to discharge across the insulator and thus burn away any built up carbon that could cause poor starting or misfires. It is not uncommon to find two, three or four ground electrode arrangements in new vehicles. The use of precious metals on the tips of the spark plug electrodes is not uncommon especially on higher performance engines. Whilst these spark plugs do have increased service life they are often specified because of their superior ignition qualities.

Our engineering departments work very closely with the engine and vehicle manufacturers to produce the ideal spark plug type for each application. Any change in production is expensive for a manufacturer and therefore new spark plug types are only produced where necessary. NGK employ the very latest production technology to ensure that every aspect is catered for – performance, economy and value.

HEAT RANGE AND HEAT DISSIPATION

Spark plugs do not produce heat in the combustion chamber. One of the functions of the spark plug is to dissipate some of the heat produced during combustion. This is mostly transferred into the cylinder head. The 'Heat Range' indicates the measure of the spark plug's ability to do this. A 'hot' spark plug is designed to maintain a sufficiently high temperature at the insulator nose to burn off carbon and oil deposits. A 'cold' spark plug is designed to allow a faster transfer of heat to the cylinder head thus preventing overheating and premature failure.

The heat range selection is obviously a complex task with many factors to take into account. NGK engineers therefore make specific recommendations for each engine and the use to which it is put.



Wide gap

BPR5ES-13



Twin ground

BKR6EK



Three ground

BCP6ET



Four ground

BKR6EQUP



Extra projected and shielded

ZFR6E-11



Precious metal

IZFR6B

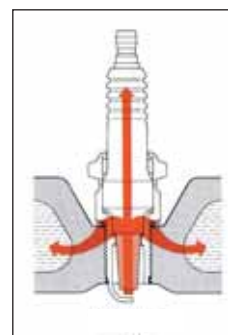

HOT TYPE
eg BR4ES

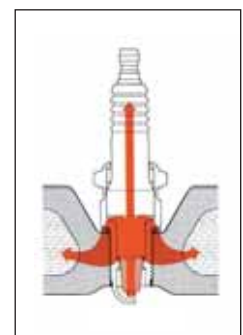

COLD TYPE
eg BR10ES

NGK'S COPPER CORE TECHNOLOGY

WIDE HEAT RANGE

A wide range spark plug is more flexible and performs equally well in a hot or cold engine under stop and go city driving or fast motorway cruising. Engines that tend to run hot need cold type plugs. Those that run cold demand a hotter type. The specific plug for any engine is determined by the plug's heat range. That is the minimum and maximum temperatures between which the plug will offer optimum performance.

The heat range of NGK Spark Plugs is wider than ordinary plugs therefore they are suitable for both high speed and low speed driving. Compared with conventional plugs of the same pre-ignition rating they have more resistance to fouling. Compared to ordinary plugs with equal anti-fouling resistance, NGK Spark Plugs have a higher pre-ignition rating.

NGK'S HEART OF COPPER

Copper wire used in place of the iron core in conventional plugs is the secret of NGK's Wide Heat Range. Copper's superior heat conductivity dissipates heat quicker. It cools the electrode tip and insulator tip which prevents hot spots that could cause pre-ignition. Increased heat resistance does not affect fouling resistance, which is primarily determined by the insulator nose length. The longer the nose, the more susceptible it is to heat and the more free from fouling. By raising the pre-ignition rating with the high conduction copper and leaving the insulator nose long, NGK produces the Wide Range Plug. One that meets the broad thermal requirements of engines under high and low RPM conditions. With the exception of a couple of older applications all the spark plugs in this motorcycle catalogue employ copper core technology.

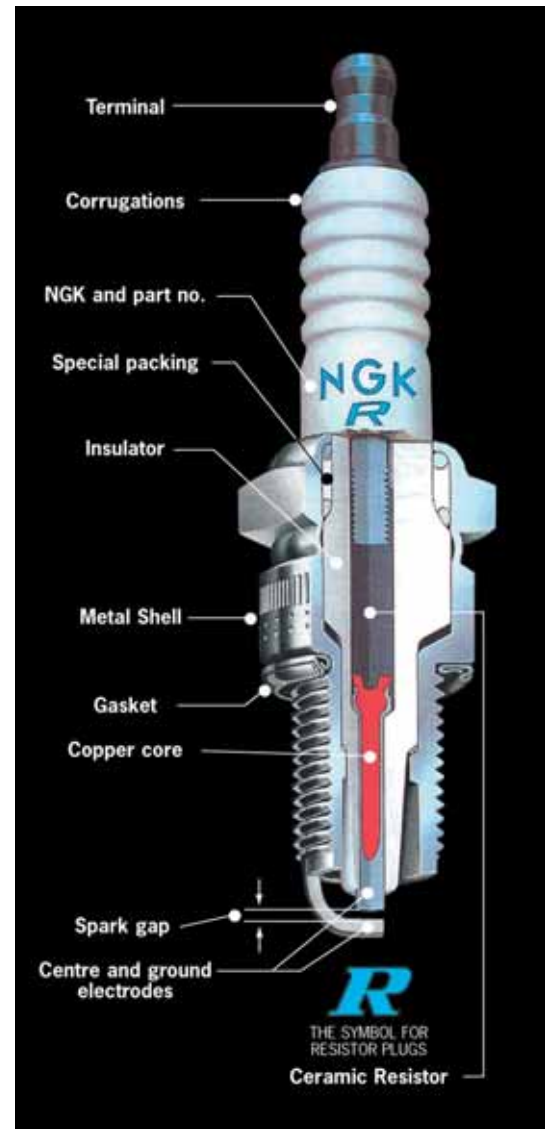

FIRING END APPEARANCE



THE BEST SPARK PLUG FOR EVERY OCCASION

As a result of our policy of continuous research and development NGK can offer special spark plugs designed to give optimum performance under a high range of conditions.

'S' TYPE (e.g. BP6ES)

NGK standard spark plugs with copper cored centre electrodes for wide heat range. Copper's superior heat conductivity dissipates the heat of combustion away from the firing end, preventing hot spots that can lead to pre-ignition. Copper cored electrodes also mean that longer insulator noses can be used to protect against fouling.

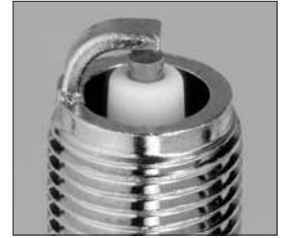

'G' TYPE (e.g. B10EG)

These plugs feature a smaller diameter centre electrode tip made of conventional nickel alloy. The smaller diameter centre electrode means the voltage required to produce a spark is reduced. However as the tip is made of conventional nickel alloy the service life is reduced and these plugs are best used in applications where plugs are frequently changed.



'V' TYPE (e.g. B10EV)

The centre electrode of this type is made of gold palladium alloy and is even smaller in diameter than the G type at 1.0mm and has therefore an even lower voltage requirement. Now mostly superseded by 'VX' types.



'GV' TYPE (e.g. B9EGV)

These plugs have a centre electrode of precious metal similar to the V range. In addition the insulator nose is an improved design to allow better gas flow around the firing end. The ground electrode is shorter and stronger, making the GV range more suited for racing applications.



'VX' TYPE (e.g. B8EVX)

These plugs have an even smaller centre electrode (0.8mm) than the V types and this is made of platinum. This combined with a taper cut ground electrode means an even lower required voltage than the V types. The result is better ignitability along with improved starting, idle stability and anti-fouling performance.



'IX' TYPE (e.g. BR8EIX)

Similar in design to the Platinum VX spark plug, the use of the precious metal Iridium allows us to manufacture a spark plug with an even smaller diameter centre electrode (0.6mm) without compromising durability. This extremely small Iridium tip centre electrode concentrates the available electrical energy and combined with the taper cut ground electrode provides the best performance in terms of starting, idling and especially throttle response.



FITTING THE CORRECT SPARK PLUG

NGK spark plugs are designed using the latest technology to give optimum performance over the engine's entire rev. range. Fitting the correct type of spark plug is essential. Many changes in engine technology has meant changes in spark plug design. Some NGK spark plugs may have a similar appearance, however the internal and or external design can differ sufficiently to cause engine damage should the incorrect part be installed. The examples below display some of the different design features employed in typical motorcycle applications and hopefully help to explain the reason for some application specific part numbers.

CR8EH-9

- Used on some Honda designed engines
- Special thread can only be used in specific engines or the cylinder head will be damaged

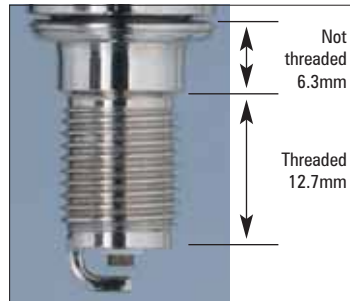

BR10ECM

- Used by Honda and Suzuki compact plug
- For use where space is restricted

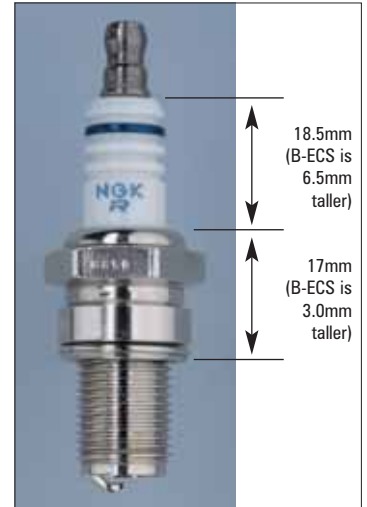

CR6HSA

- Centre electrode is 0.2mm wider than CR6HS for improved durability
- Short metal shell design



CR9EK, JR9C

- Used by Kawasaki and Suzuki
- 2 ground electrodes for improved durability



CR9EK thread diameter \varnothing 10mm



JR9C thread diameter \varnothing 12mm

ER9EH

- Used by Honda, \varnothing 8mm thread with 13mm hex
- Do not exceed the tightening torque of 0.8 - 1.0kg/m

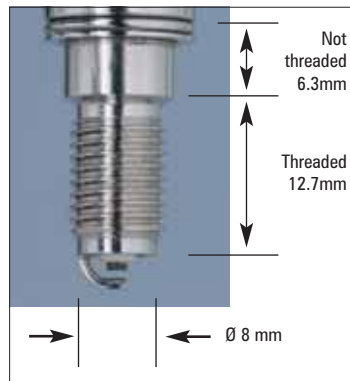

B9ECS

- Short ground electrode for strength and to prevent overheating
- For competition use



THE IRIIDIUM IX SPARK PLUG

The Iridium IX spark plug is similar in design to the Platinum VX type but benefits from the use of the precious metal Iridium on its centre electrode. Iridium is harder than other precious metals used in spark plug manufacture, has an extremely high melting point and offers greater protection from chemical attack. These features allow the use of an extremely small diameter electrode (0.6mm) without compromising the spark plug's service life. Combined with the use of the taper cut ground electrode this spark plug has superior gas flow properties and lower voltage requirements, which offers further improvements in starting, idling and throttle response.

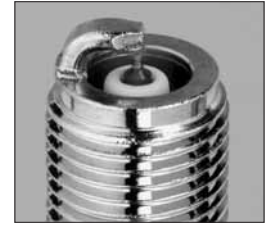

BR8EIX

Iridium spark plugs are used by some of the worlds leading race teams and as original equipment in many high performance road and off road machines. Owners who want the very best performance from their bikes will want the best spark plug and this we can offer with Iridium IX.



Iridium IX

A small diameter electrode that gives good gas flow and less restriction of flame kernel

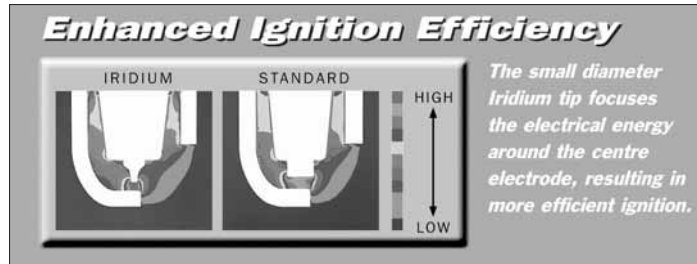

Iridium IX packaging

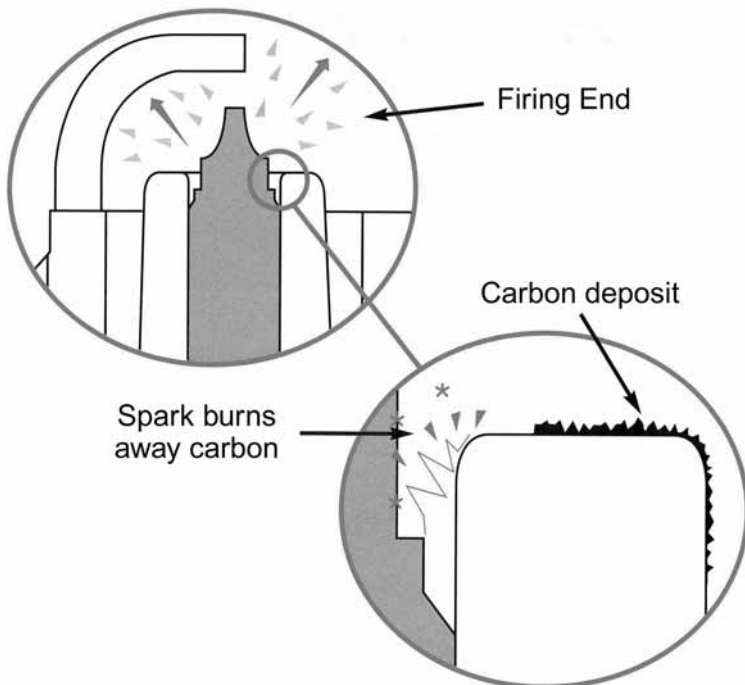

The close up section shows the annular gap between the centre electrode and insulator nose which provides cold fouling protection.

Should current try to leak away across a carbonised insulator a spark can occur between the electrode and the insulator thus burning away the carbon deposit.

THE IRIIDIUM IX SPARK PLUG

The tables below show the Iridium IX upgrade from standard copper core and Platinum VX type. For specific model application refer to the Iridium column in the main data pages.

STANDARD COPPER CORE		PLATINUM VX		IRIDIUM IX	
PART NO.	PART NO.	PART NO.	PART NO.	PART NO.	STOCK NO.
BK6E	BKR6E		BKR6EVX	BKR6EIX	6418
	BKR6E-11			BKR6EIX-11	3764
	BKR7E		BKR7EVX	BKR7EIX	2667
BP5ES	BPR5ES			BPR5EIX	6597
BP6ES	BPR6ES		BPR6EVX	BPR6EIX	6637
	BPR6ES-11			BPR6EIX-11	3903
BP6HS	BPR6HS			BPR6HIX	4085
BP6HS-10	BPR6HS-10 BR6HSA				
BP7ES	BPR7ES	BP7EVX		BPR7EIX	4055
BP7HS	BPR7HS			BPR7HIX	5944
BP7HS-10	BPR7HS-10				
BP8HS	BPR8HS			BPR8HIX	6742
BP8HS-10	BR8HSA				
B6HS	BR6HS			BR6HIX	3419
B6HS-10	BR6HS-10				
B7ES	BR7ES			BR7EIX	6664
B7HS	BR7HS			BR7HIX	7067
B7HS-10	BR7HS-10				
B8ES	BR8ES	B8EVX		BR8EIX	5044
B8HS	BR8HS	B8HVX		BR8HIX	7001
B8HS-10	BR8HS-10				
B9ES	BR9ES	B9EVX		BR9EIX	3981
	BR10ES	B10EVX		BR10EIX	6801
C6HSA	CR6HSA CR6HS			CR6HIX	7274
	CR7E			CR7EIX	7385

STANDARD COPPER CORE		PLATINUM VX		IRIDIUM IX	
PART NO.	PART NO.	PART NO.	PART NO.	PART NO.	STOCK NO.
C7HSA	CR7HSA CR7HS			CR7HIX	7544
	CR8EH-9			CR8EHIX-9	3797
C8E	CR8E CR8EK			CR8EIX	4218
C8HSA	CR8HSA CR8HS		CR8HVX	CR8HIX	7669
	CR9EH-9			CR9EHIX-9	6216
C9E	CR9E			CR9EIX	3521
	CR10E CR10EK			CR10EIX	6482
	DCPR7E		DCPR7EVX	DCPR7EIX	6046
	DCPR8E DCPR8EKC			DCPR8EIX	6546
	DCPR9E		DCPR9EVX	DCPR9EIX	2316
	DCPR7E#			DCR7EIX	3605
	DCPR8E#			DCR8EIX	3606
	DCPR9E#			DCR9EIX	6650
	DPR7EA-9		DPR7EVX-9	DPR7EIX-9	7803
DP8EA-9	DPR8EA-9			DPR8EIX-9	2202
	DPR9EA-9			DPR9EIX-9	5545
D8EA	DR8EA DR8ES-L	D8EVX	DR8EVX	DR8EIX	6681
D9EA	DR9EA DR8ES* JR9B	D9EVX	DR9EVX	DR9EIX	4772

*The upgrade from DR8ES to DR9EIX is correct
For plugs with threaded terminal

As the IX range now takes over the premium motorcycle spark plug position from the popular Platinum VX range we will be superseding some current versions of Platinum VX types as volume production allows. This will be treated as a running change and therefore orders placed for certain resistor VX types will be fulfilled by supplying the Iridium IX equivalent. Most contemporary machines demand the use of resistor types and most older machines can and do use them quite happily.

Below is a chart to show the VX plugs currently affected.

Platinum VX		replaced by	Iridium IX	
Platinum VX	Stock Code		Iridium IX	Stock Code
B7EVX	6934	→	BR7EIX	6664
B7HVX	7836	→	BR7HIX	7067
BP5EVX	5470	→	BPR5EIX	6597
BPR5EVX	4875	→	BPR5EIX	6597
BR8EVX	1262	→	BR8EIX	5044
BR9EVX	1265	→	BR9EIX	3981
BPR9EVX	5576	→	BPR9EIX	6583
CR8EHVX-9	4546	→	CR8EHIX-9	3797
CR8EVX	6487	→	CR8EIX	4218
CR9EHVX-9	3872	→	CR9EHIX-9	6216
CR9EVX	5943	→	CR9EIX	3521
DPR8EVX-9	2872	→	DPR8EIX-9	2202
DPR9EVX-9	3854	→	DPR9EIX-9	5545

SPARK PLUG INSTALLATION TIPS

- Refer to current NGK catalogue for correct spark plug selection
- Check condition and cleanliness of threads in cylinder head
- Ensure plug is gapped according to vehicle manufacturers specification
- Multi ground electrode and precious metal plugs should not be regapped - visual inspection only
- Install new spark plug *by hand* until it seats - a length of rubber tubing pushed over the insulator can be a useful aid for plug installation where access is difficult
- Tighten to specified torque setting as shown in the chart below
- If torque wrench is unavailable the image below will serve as a *guide* for tightening *new* spark plugs
- Reused gasket type spark plugs require only 1/12 turn
- Always use the correct tools for removal/installation to prevent damage to the spark plug or engine
- Inspect spark plug cover and renew if necessary

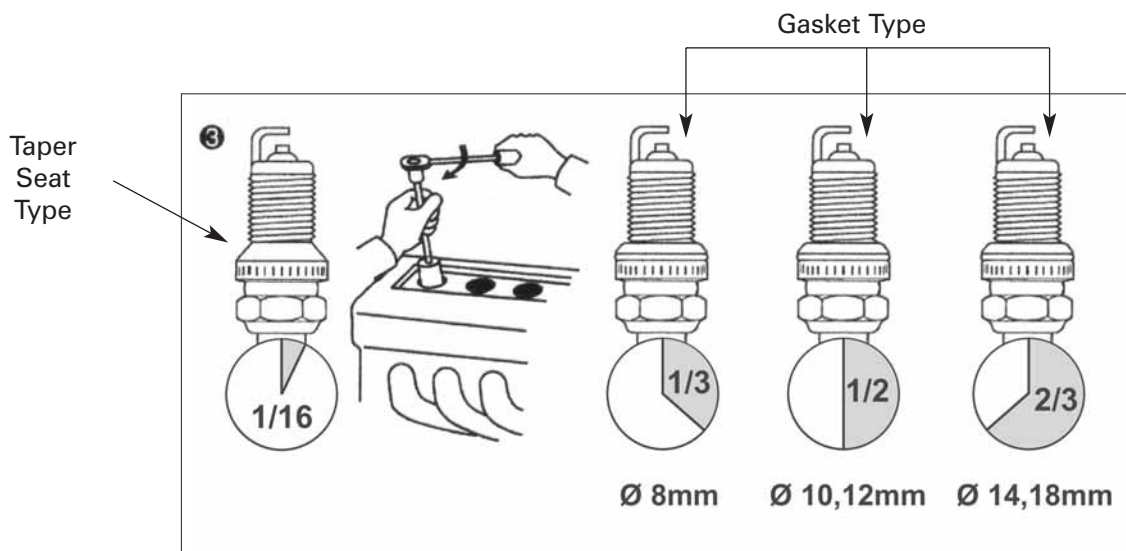
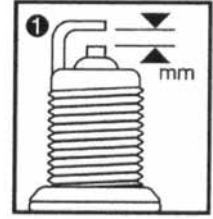

Important: Some spark plugs differ in gasket design or material, refer to tightening advice on specific spark plug packaging

TORQUE TIGHTENING CHART

FOR FLAT SEAT TYPE (WITH GASKET)						TAPER SEAT TYPE	
Thread Ø	18mm	14mm	12mm	10mm	8mm	18mm	14mm
Cast iron head	35-45Nm (3.5-4.5kgm) (25.3-32.5lbs ft)	25-35Nm (2.5-3.5kgm) (18.0-25.3lbs ft)	15-25Nm (1.5-2.5kgm) (10.8-18.0lbs ft)	10-15Nm (1.0-1.5kgm) (7.2-10.8lbs ft)		20-30Nm (2.0-3.0kgm) (14.5-21.6lbs ft)	15-25Nm (1.5-2.5kgm) (10.8-18.0lbs ft)
Aluminium head	35-40Nm (3.5-4.0kgm) (25.3-28.9lbs ft)	25-30Nm (2.5-3.0kgm) (18.0-21.6lbs ft)	15-20Nm (1.5-2.0kgm) (10.8-14.5lbs ft)	10-12Nm (1.0-1.2kgm) (7.2-8.7lbs ft)	8-10Nm (0.8-1.0kgm) (5.8-7.2lbs ft)	20-30Nm (2.0-3.0kgm) (14.5-21.6lbs ft)	10-20Nm (1.0-2.0kgm) (7.2-14.5lbs ft)

DESIGN SYMBOLS

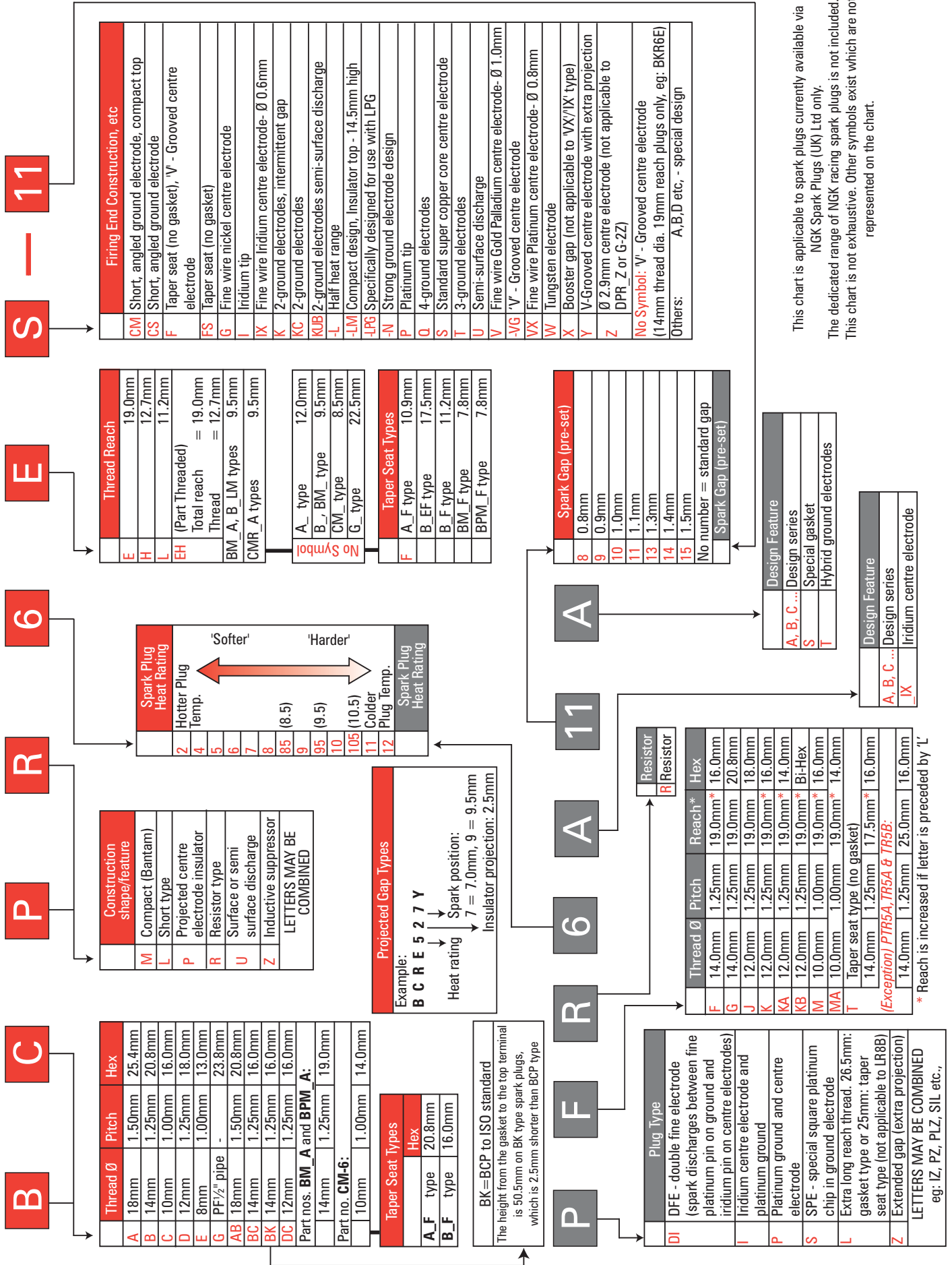

This chart is applicable to spark plugs currently available via NGK Spark Plugs (UK) Ltd only.
The dedicated range of NGK racing spark plugs is not included. This chart is not exhaustive. Other symbols exist which are not represented on the chart.

NEW ADDITIONS AND PART NUMBERS

These are new additions to this catalogue that have new part numbers not previously stocked by NGK Spark Plugs (UK) Ltd.

Part Number	Stock Number	Application		Part Number	Stock Number	Application	
CR8EIA-9	4286	SUZUKI	SFV650 Gladius	LMAR9E-J	6884	YAMAHA	YZF-R1 09→
CR8EKB	4374	APRILIA	RXV / SXV 4.5/5.5 09→	MAR9A-J	6869	BMW	HP2 Sport
ER9EH-6N	1673	PIAGGIO / VESPA	Vespa S 50 08→	R0451B-8	9356	HONDA	CRF250R 10→
ILZKAR7B11	1654	KAWASAKI	VN1700 (Classic/Tourer)	SILMAR9A9S	6213	HONDA	CRF450R 09→
LMAR6A-9	5946	YAMAHA	YFM700FWAD Grizzly Fi (Quad)				

These Spark Plugs will be available during 2009/2010

Listed below is a selection of new applications for existing spark plugs

MAKE	MODEL	PART NO.	STOCK NO.
APRILIA	SX 50	BR9ES	5722
	SX 125	BR10EG	3830
	Pegaso Factory	CR7E	4578
	Shiver GT (Half faired)	CR7EK	7546
	RSV 4 Factory	CR9EB	6955
ARTIC CAT (Quads)	150	DR8EA	7162
	400 H1	CR7E	4578
	550 / 700 H1 / 1000 Thundercat H2	CPR8E	7411
BAROSSA	XS125T-13	CR7HSA	4549
BENELLI	49X Quattro Nove / Road / Trek	BR8HSA	5539
	TNT 899/S / TNT 1130 Sport Evo/Titanium	CR9E	6263
	TNT Café Racer 1130 / Tre K Amazonas	CR9E	6263
BETA / BETAMOTOR	RR 50 Motard	BR9ES	5722
	EVO 80/Junior	BR8ES	5422
	R107-4T	C7HSA	4629
	EVO 125 2T / 200 2T / 250 2T / 290 2T	BR7ES	5122
	EVO 250 4T / EVO 300 4T	CR7EB	4663
BIMOTA	DB5 / DB6 Delirio / DB5R/S / DB6R/S	DCPR8E	4339
	DB7	MAR10A-J	4706
BMW	G450X	CR9EKB	2305
	F800R	DCPR8E	4339
	K1300GT / K1300R / K1300S	KR9CI	7795
BOMBARDIER (Quads)	DS 7	CR7HSA	4549
	DS 250	CR8E	1275
	DS 450	DCPR9E	2641
	Outlander 500 / Renegade 500 / Traxter CVT	DCPR8E	4179
	Outlander 650 / Outlander 800 / Renegade 800	DCPR8E	4179
BUELL	XB9X (City X)	DCPR9E	2641
	1125CR (Café Racer)	CR9EKB	2305
CAGIVA	Mito 525SP	BR9EG	3230
DUCATI	996 S	DCR9EIX	6650
	Dark / 996 R / 998 Matrix / S4R/S4R2 Monster	CR9EB	6955
	Monster 1100/S / Multistrada 1100/S	DCPR8E	4339
	Streetfighter / 1098R (Incl. Bayliss LE)/ 1198/S	MAR10A-J	4706

MAKE	MODEL	PART NO.	STOCK NO.
GAS GAS	Quad 250	DPR7EA-9	5129
GILERA	DNA 50 GP / SMT 50 / Storm 50	BR9ES	5722
	SC125 (2-Stroke)	BR8ES	5422
	Runner ST 200	CR8EB	7784
	GP800	CR7EKB	4455
HARLEY DAVIDSON	XR1200	DCPR9E	2641
HONDA	XR50 Motard	CR6HSA	2983
	XR100 Motard	CR7HSA	4549
	Lead (Fi) / SH125i / S-Wing 125 / CRF150R/B	CR8EH-9	5666
	ANF125i Innova	CPR6EA-9	6899
	CBF125	CPR7EA-9	3901
	TRX420 FE/FM/TE/TM	BKR5E-11	6953
	Fourtrax ES (Quad)		
	CRF450X	IFR8H11	5068
	CB600F/FA (Hornet) (Incl. ABS)	CR9EH-9	7502
	CBF600 N/S (Including ABS)	CR8EH-9	5666
HUSABERG	CBR600RR (Incl ABS) / CB1000R/RA	IMR9E-9HES	7556
	VT750DC Shadow Spirit	DPR7EA-9	5129
	CB1300S (Including ABS)	DPR8EA-9	4929
HUSABERG	FE 450 / FE 570	LKAR8AI-9	6706
HYOSUNG	GV125C / MS3-125	CR8E	1275
	HD125 Hyper	DR8EA	7162
	RT125 / XRX125	CR8EH-9	5666
	RT125D / RX125D SM / RX125D-E	CR8E	1275
	GT250/R / GV250 EFI / MS3-250	CR8E	1275
	TE450 Rapiere (Quad)	CR8E	1275
	GT650/R / GT650S / GV650	CR8E	1275
JINLUN	JL50QT / Hornet 125	CR7HSA	4549
	JL125-11/13 / JL125-C/Y / JL125T	CR7HSA	4549
	JL150	D8EA	2120
	JL250	CR7HSA	4549
KAWASAKI	KX100 D1-D5, D6F-D9F	R6252K-105	2741
	KLX250 T9F	CR8E	1275
	KX450F	CPR8EB-9	6607
	ZX600 R9F / ZX636 C1H-C6F (Ninja ZX-6R)	CR9E	6263
	VN900 C7F (Custom)	CPR7EA-9	3901

NEW ADDITIONS AND PART NUMBERS

MAKE	MODEL	PART NO.	STOCK NO.
KTM	SX 125 (2001) / 150 SX	BR9ECMVX	2434
	250 SX 06→	BR8ECM	3035
	300 EXC 07→	BR7ES	5122
	690 Duke / Enduro R / SMC / SM R	LKAR8AI-9	6706
	990 SM-R/T	KR8DI	4742
	990 LC8 Super Duke R	LKAR8AI-9	6706
	RC8R	LKAR9BI9	6205
	KYMCO	MXU 150 RL (ATV)	DR8EA
MXU 300 RL / Maxxer 300 (ATV)		DPR7EA-9	5129
MOTO GUZZI	V7 Café Classic / Classic	BR8ES	5422
	California Vintage (Twin Spark) (Ø14mm Plug)	BPR6ES	7822
	California Vintage (Twin Spark) (Ø10mm Plug)	PMR8B	6378
	Griso 8V / Griso 8V SE	PMR8B	6378
	Sport 1200 (Twin Spark) (Ø14mm Plug)	BPR6ES	7822
	Sport 1200 (Twin Spark) (Ø10mm Plug)	PMR8B	6378
	Sport 1200 V4 / Stelvio 1200 TT (NTX)	PMR8B	6378
	PEUGEOT	XPS CT125	CR7HSA
PGO	Libra 50 / Ligerio 50 / PMX Naked 50	BPR7HS	6422
	Libra 125 / Ligerio 125	C7HSA	4629
	G Max 250	DPR7EA-9	5129
PIAGGIO / VESPA	Vespa LX V 125	CR7EB	4663
	Vespa GT V 125	CR8EB	7784
SACHS	MadAss 125	C7HSA	4629
SCORPA	4-Tricks / SY 125 F / SY 175 F / SY 250 FR	CR7HIX	7544
		CR8EIX	4218
	SY 250 Long Ride / SY 250 Racing	BKR5EVX	2546
	T-Ride 250F	CR8EIX	4218
SINNIS	Eagle, Ghost, Hawk, Nitro, Pioneer, Strike	BPR7HS	6422
	Falcon, Jet (4-Stroke) / Breeze	CR7HSA	4549
	Apache, Blade, Max, Stealth, Vista	CR8E	1275
	Eagle, Matrix, Matrix II, Nitro, Pioneer, Sublime	CR7HSA	4549
	Apache, Blade	DR8ES-L	2923
SUZUKI	DR-Z70	CR7HIX	7544
	DR125SM	CR8EIX	4218
	LT-F250 (Quad) 03→	DR7EA	7839
	AN400 K7-K8 Burgman	CR7EIX	7385
	LT-A450X / LT-A750X (Quad)	CR6E	6965
	GSX-R600 K8-K9 / GSX-R750 K8-K9	CR9EIA-9	6289
	VZR1800 C1800R/RT Intruder 08→	CR8EIX	4218
SYM	Simply 50 / Fiddle 125 / Simply 125	CR7HSA	4549
	Joyride 200 / Citycom 300 / GTS 300	CR8E	1275
TGB	202 Classic / 302 Sport / 303R Hawk	BPR7HS	6422
	AKROStec / Delivery 50 / R50X	BPR7HS	6422
	204 Classic / 303R Hawk / 304 Sport	CR7HSA	4549
	404 Executive / Delivery 125 / R125X	CR7HSA	4549
TRIUMPH	Daytona 675 Triple 08→ / Street Triple/R	CR9EK	4548
	America 900 / Bonneville SE	DPR8EA-9	4929
	Thunderbird	DPR6EA-9	5531
	Rocket III Touring (Twin Spark)	DPR7EA-9	5129
VICTORY (Polaris)	All 106 cu.inch models	DCPR6E	3481

MAKE	MODEL	PART NO.	STOCK NO.
YAMAHA	YFM40 Big Bear Manual (Quad)	DR8EA	7162
	CS50Z Jog RR	BR8HS	4322
	YN50 Neo's 4s	CR7E	4578
	YXR70FX Rhino Fi (Quad)	CPR7EA-9	3901
	YDR-A (The DRIVE) (Golf Kart)	BPR2ES	2264
	Black X-max 125 / VP125 X-City	CPR9EA-9	2308
	WR125R/X / YZF-R125 / YZ250F (S)	CR8E	1275
	YBR125 Custom	CR6HSA	2983
	Black X-max 250	DR8EA	7162
	VP250 X-City	DPR8EA-9	4929
	WR250F (S) 07→	CR9E	6263
	WR250X	CR9EK	4548
	YFM45 Grizzly / Kodiak (Quad)	DR8EA	7162
	YFZ450R (Quad)	CR8E	1275
	FZ6-S S2 / Fazer S2 / XJ6/ Diversion (Incl. ABS)	CR9EK	4548
	YZF-R6 (2006)	CR10EK	2360
	XT660Z Tenere	CR7E	4578
	YFM700 Grizzly Fi (Quad)	CPR7EA-9	3901
	XVS950A Midnight Star	CPR7EA-9	3901
	YZF-R1SP	CR9EK	4548
	FJR1300A/AS 06→	CR8E	1275
	V-Max 1700	CR9EIA-9	6289

The above tables are intended as a stock purchase guide.

Refer to the relevant model listing in the main application section for product selection.



CC	MODEL	DATE	STANDARD COPPER CORE	STOCK NUMBER	PLATINUM OR GOLD PALLADIUM	STOCK NUMBER	IRIDIUM	STOCK NUMBER	GAP MM
ADLY									
50	Citybird, Fox, Jet X1, Crosser, Predator, Pista	97→	BPR7HS	6422			BPR7HIX	5944	0.6
100	Cat, Predator, Jet, X1	97→	BPR7HS	6422			BPR7HIX	5944	0.6
125	Activator 125	99→	CR7HSA	4549			CR7HIX	7544	0.5
	AJP 125 PR4	03→	DPR7EA-9	5129	DPR7EVX-9	7682	DPR7EIX-9	7803	0.9
	Cat 125	97→	CR7HSA	4549			CR7HIX	7544	0.5

AJS									
50	Chipmunk 50	03→	BP4HS	3611					0.6
	DD50 Regal Raptor	03→	CR7HS	7223			CR7HIX	7544	0.7
80	Coyote 80	03→	BP6HS	4511			BPR6HIX	4085	0.6
100	Cougar 100 (Jincheng)	03→	BP7HS	5111			BPR7HIX	5944	0.6
	DD100 Regal Raptor	03→	CR7HS	7223			CR7HIX	7544	0.7
125	JS125Y Tiger	03→	DR8ES	5423	DR9EVX	6361	DR9EIX	4772	0.7

APRILIA									
50	AF1 50	88→92	B8ES	2411	B8EVX	7051	BR8EIX	5044	0.5
	Amico 50	92→94	BR7HS	4122			BR7HIX	7067	0.6
	Area 51 (Liquid Cooled 2-Stroke)	98→	BR8HS	4322			BR8HIX	7001	0.5
	Extrema 50	93→	B8ES	2411	B8EVX	7051	BR8EIX	5044	0.5
	Gulliver	97→99	BR7HS	4122			BR7HIX	7067	0.6
	Habana 50, Custom & Retro	99→05	BPR8HS	3725			BPR8HIX	6742	0.6
	Mojito Custom 50	05→	BR9ES	5722			BR9EIX	3981	0.7
	MX50	03→	BR9ES	5722			BR9EIX	3981	0.7
	Rally 50 (Air Cooled)	95→99	BR7HS	4122			BR7HIX	7067	0.7
	Rally 50 (Liquid Cooled)	97→03	BR8HS	4322			BR8HIX	7001	0.5
	Red Rose 50	93→	B8ES	2411	B8EVX	7051	BR8EIX	5044	0.5
	RS 50 (Minarelli Engine)	93→	B8ES	2411	B8EVX	7051	BR8EIX	5044	0.6
	RS 50	01→	BR9ES	5722			BR9EIX	3981	0.7
	RX 50 (Minarelli Engine)	97→	B9ES	2611	B9EVX	7254	BR9EIX	3981	0.6
	Scarabeo 50 Carb	93→	BR7HS	4122			BR7HIX	7067	0.6
	Scarabeo 50 Di Tech (Injection)	01→	CPR8E	7411					0.8
	Scarabeo 50 4T (4-Stroke)	06→	CR9EB	6955			CR9EIX	3521	0.6
	Sonic FT 50 (Air Cooled 2-Stroke)	98→01	BR8HS	4322			BR8HIX	7001	0.5
	Sonic GP 50 (Liquid Cooled 2-Stroke)	98→05	BR8HS	4322			BR8HIX	7001	0.5
	SR 50 (Air Cooled)	94→	BR7HS	4122			BR7HIX	7067	0.7
	SR 50 Stealth / LC / Racing (Liquid Cooled)	96→	BR7HS	4122			BR7HIX	7067	0.7
	SR 50 Carb (19mm Thread Reach)	04→	BR9ES	5722			BR9EIX	3981	0.6
	SR 50 Di Tech Injection	01→04	CPR8E	7411					0.8
	SR 50 Di Tech Injection	05→			ZMR7AP	6914			0.8
	SR 50 i.e. Pure Jet	04→			ZMR7AP	6914			0.8
	SR 50 WWW	01→02	BR7HS	4122			BR7HIX	7067	0.6
	SR 50R	05→	BR9ES	5722			BR9EIX	3981	0.6
SX 50	06→	BR9ES	5722			BR9EIX	3981	0.6	
100	Scarabeo 100	00→	BR8HS	4322			BR8HIX	7001	0.6
125	AF1 125	88→	BR10EG	3830			BR10EIX	6801	0.5
	AF1 Futura	90→93	BR10EG	3830			BR10EIX	6801	0.5
	Atlantic 125	03→	CR8EB	7784			CR8EIX	4218	0.8
	Classic 125	99→	BR10EG	3830			BR10EIX	6801	0.6
	ETX 125 (Liquid Cooled 2-Stroke)	98→01	BR8ES	5422			BR8EIX	5044	0.5
	Europa 125	90→	BR10EG	3830			BR10EIX	6801	0.5
	Habana 125 Custom & Retro (4-Stroke)	99→	CR8E	1275			CR8EIX	4218	0.6
	Leonardo 125	95→	CR8E	1275			CR8EIX	4218	0.6
	Leonardo 125 ST	04→					CR8EIX	4218	0.6
	Mojito Custom 125	05→	CR7EB	4663			CR7EIX	7385	0.6
	MX125	04→	BR8ES	5422			BR8EIX	5044	0.6
	Pegaso 125	92→96	BR10EG	3830			BR10EIX	6801	0.5
	Rally 125	89→90	B10EG	3630	B10EGV	5927	BR10EIX	6801	0.5
	Red Rose 125	88→94	BR10EG	3830			BR10EIX	6801	0.5
	RS 125 (12BHP Restricted Engine)	93→	BR8ES	5422			BR8EIX	5044	0.5
	RS 125 (35BHP Unrestricted Engine)	93→	BR10EG	3830			BR10EIX	6801	0.5
	RS 125R Extrema (12BHP Restricted Engine)	93→	BR8ES	5422			BR8EIX	5044	0.5
	RS 125R Extrema (35BHP Unrestricted Engine)	93→	BR10EG	3830			BR10EIX	6801	0.5
	RS125 Tuono	03→	BR8ES	5422			BR8EIX	5044	0.6

2 Wheel



CC	MODEL	DATE	STANDARD COPPER CORE	STOCK NUMBER	PLATINUM OR GOLD PALLADIUM	STOCK NUMBER	IRIDIUM	STOCK NUMBER	GAP MM
APRILIA (CONTINUED)									
125	RX125	94→96	BR10EG	3830			BR10EIX	6801	0.5
	Scarabeo 125cc (4-Stroke)	99→	CR8E	1275			CR8EIX	4218	0.6
	Sport City 125	04→	CR8E	1275			CR8EIX	4218	0.6
	Sport Pro 125		BR10EG	3830			BR10EIX	6801	0.5
	SR 125	04/99→	BR8ES	5422			BR8EIX	5044	0.5
	SR 125AC	00→	BR8ES	5422			BR8EIX	5044	0.5
	SX 125	08→	BR10EG	3830			BR10EIX	6801	0.5
	Tuareg Wind 125	89→91	B10EG	3630	B10EGV	5927	BR10EIX	6801	0.5
150	Leonardo 150	98→01	CR8E	1275			CR8EIX	4218	0.6
	Leonardo 150 ST	02→					CR8EIX	4218	0.6
	Scarabeo 150 (4-Stroke)	99→	CR8E	1275			CR8EIX	4218	0.6
200	Atlantic 200	03→	CR8EB	7784			CR8EIX	4218	0.8
	Scarabeo 200 (4-Stroke)	00→	CR8E	1275			CR8EIX	4218	0.6
	Sportcity 200	04→	CR7EB	4663			CR7EIX	7385	0.6
250	Atlantic 250	04→	CR8EB	7784			CR8EIX	4218	0.7
	Leonardo 250	99→03	DR8EA	7162	DR8EVX	6354	DR8EIX	6681	0.6
	RS 250	94→	BR9ECM	3252	BR9ECMVX	2434			0.7
	Scarabeo 250	04→	CR8EB	7784			CR8EIX	4218	0.7
	Sport City 250	04→	CR8EB	7784			CR8EIX	4218	0.7
280	Climber trials bike	89→			BP6EVX	5832	BPR6EIX	6637	0.6
300	Leonardo 300	04→	DR8EA	7162	DR8EVX	6354	DR8EIX	6681	0.6
	Sportcity Cube	08→	CR8EKB	4374			CR8EIX	7385	0.8
400	Atlantic 400 Sprint	06→	CR7EKB	4455			CR7EIX	7385	0.8
450	RXV 4.5	06→08	CR8EB	7784			CR8EIX	4218	0.7
	RXV 4.5	09→	CR8EKB	4374			CR8EIX	7385	0.8
	SXV 4.5	06→08	CR8EB	7784			CR8EIX	4218	0.7
	SXV 4.5	09→	CR8EKB	4374			CR8EIX	7385	0.8
500	Atlantic 500	01→	CR7EKB	4455			CR7EIX	7385	0.8
	Atlantic 500 Sprint	05→	CR7EKB	4455			CR7EIX	7385	0.8
	Scarabeo 500	03→	CR7EKB	4455			CR7EIX	7385	0.8
550	RXV 5.5	06→08	CR8EB	7784			CR8EIX	4218	0.7
	RXV 5.5	09→	CR8EKB	4374			CR8EIX	7385	0.8
	SXV 5.5	06→08	CR8EB	7784			CR8EIX	4218	0.7
	SXV 5.5	09→	CR8EKB	4374			CR8EIX	7385	0.8
600	Pegaso 600	92→	D8EA	2120	D8EVX	2850	DR8EIX	6681	0.6
	Tuareg 600	88→	D8EA	2120	D8EVX	2850	DR8EIX	6681	0.6
650	Moto 6.5 (650)	95→	D8EA	2120	D8EVX	2850	DR8EIX	6681	0.7
	Pegaso 650 (Carburettor)	93→00	D8EA	2120	D8EVX	2850	DR8EIX	6681	0.6
	Pegaso 650 (Injection) Ø12mm Plug	01→04	DR8EB	4855	DR8EVX	6354	DR8EIX	6681	0.7
	Pegaso Strada & Trail 650 Ø10mm Plug	05→	CR7E	4578			CR7EIX	7385	0.7
	Pegaso Factory	02/07→	CR7E	4578			CR7EIX	7385	0.7
750	Shiver GT (Half faired)	09→	CR7EK	7546			CR7EIX	7385	0.7
	SL 750 Shiver	07→	CR7EKB	4455			CR7EIX	7385	0.8
	SMV 750 Dorsoduro	07→	CR7EK	7546			CR7EIX	7385	0.7
850	NA 850 Mana	08→	CR7EKB	4455			CR7EIX	7385	0.6
1000	ETV 1000 Capo Nord	01→	DCPR9E	2641	DCPR9EVX	6436	DCPR9EIX	2316	0.6
	RST 1000 Futura	01→	DCPR9E	2641	DCPR9EVX	6436	DCPR9EIX	2316	0.6
	RSV 1000 R Factory	04→	DCPR9E	2641	DCPR9EVX	6436	DCPR9EIX	2316	0.6
	RSV 4 Factory	09→	CR9EB	6955			CR9EIX	3521	0.7
	RSV Mille	98→	DCPR9E	2641	DCPR9EVX	6436	DCPR9EIX	2316	0.6
	RSV Mille R	98→03	DCPR9E	2641	DCPR9EVX	6436	DCPR9EIX	2316	0.6
	RSV Mille R 2004	03→	DCPR9E	2641	DCPR9EVX	6436	DCPR9EIX	2316	0.6
	RSV Mille SP (Sport Production)	00→03	R0045J-10	7400					1.1
	RSV Mille Tuono	02→	DCPR9E	2641	DCPR9EVX	6436	DCPR9EIX	2316	0.6
	SL 1000 Falco	99→	DCPR9E	2641	DCPR9EVX	6436	DCPR9EIX	2316	0.6
	Tuono 1000	04→	DCPR9E	2641	DCPR9EVX	6436	DCPR9EIX	2316	0.6
	Tuono 1000 R	05→	DCPR9E	2641	DCPR9EVX	6436	DCPR9EIX	2316	0.6

ATALA									
50	Byte		B7HS	5110			BR7HIX	7067	0.5
	Carosello		B7HS	5110			BR7HIX	7067	0.5
	Hacker AT 12, Hacker Racing		BPR6HS	7022			BPR6HIX	4085	0.6
	Master		B6HS	4510			BR6HIX	3419	0.6
	Skeggia		BPR6HS	7022			BPR6HIX	4085	0.6



CC	MODEL	DATE	STANDARD COPPER CORE	STOCK NUMBER	PLATINUM OR GOLD PALLADIUM	STOCK NUMBER	IRIDIUM	STOCK NUMBER	GAP MM
BAJAJ									
50	Sunny/Bonnie 50	93→	B6HS	4510			BR6HIX	3419	0.5
100	KB100	93→	B8ES	2411	B8EVX	7051	BR8EIX	5044	0.5
125	Vespa/Chetak (125 Scooter)	93→	B6HS	4510			BR6HIX	3419	0.5
150	Chetak 150	01→	BPR5HS	6222					0.7

BAOTIAN									
50	BT49QT-9 / -11 / -12	04→	CR7HSA	4549			CR7HIX	7544	0.6
110	BT110-2	04→	CR7HSA	4549			CR7HIX	7544	0.6
125	Citybike 125	04→	CR7HSA	4549			CR7HIX	7544	0.6
	Tanco 125	04→	CR7HSA	4549			CR7HIX	7544	0.6

BAROSSA									
125	XS125T-13	12/07→	CR7HSA	4549			CR7HIX	7544	0.6

BASHAN									
110	BS110 GY	01→	C7HSA	4629			CR7HIX	7544	0.6
125	BS125 GY	01→	D8EA	2120	D8EVX	2850	DR8EIX	6681	0.6
200	BS200 GY	01→	D8EA	2120	D8EVX	2850	DR8EIX	6681	0.6

BATAVUS									
50	Mondial		B6HS	4510			BR6HIX	3419	0.4
	Stargoi		B7HS	5110			BR7HIX	7067	0.5

BENELLI									
50	3G2		B6ES	7310					0.5
	491 Sport / ST GP / Rage / RR SBK / RR GP	98→	BR8HS	4322			BR8HIX	7001	0.5
	49X Quattro Nove	08→	BR8HSA	5539			BR8HIX	7001	0.8
	49X Road	08→	BR8HSA	5539			BR8HIX	7001	0.8
	49X Trek	08→	BR8HSA	5539			BR8HIX	7001	0.8
	50 Cross		B6ES	7310					0.5
	G2 Elle		B6ES	7310					0.5
	K2, K2 Air	98→	BR8HS	4322			BR8HIX	7001	0.5
	Motorella		B6ES	7310					0.5
	Namur 50		BR8HS	4322			BR8HIX	7001	0.5
Pepe	00→	BR8HS	4322			BR8HIX	7001	0.5	
100	K2 100	99→	BR8HS	4322			BR8HIX	7001	0.5
125	125 Roadster/Cross		B7ES	1111			BR7EIX	6664	0.5
	Adiva	00→	CR8EB	7784			CR8EIX	4218	0.8
	Velvet 125	99→	CR8E	1275			CR8EIX	4218	0.6
150	Adiva 150	00→	CR8E	1275			CR8EIX	4218	0.6
230	254 & 304	80→	B7HS	5110			BR7HIX	7067	0.5
250	250 (4 Cyl)		C7HSA	4629			CR7HIX	7544	0.5
	250 Super		B8ES	2411	B8EVX	7051	BR8EIX	5044	0.5
	Adiva		CR8EB	7784			CR8EIX	4218	0.8
	Velvet 250	00→	CR8E	1275			CR8EIX	4218	0.6
350	354 Sei	80→	D8EA	2120	D8EVX	2850	DR8EIX	6681	0.5
400	Velvet 400	03→04	CR9E	6263			CR9EIX	3521	0.7
500	Quatro 500	99→	D8EA	2120	D8EVX	2850	DR8EIX	6681	0.5
650	654 Sei	80→	D8EA	2120	D8EVX	2850	DR8EIX	6681	0.5
750	750 Sei		D8EA	2120	D8EVX	2850	DR8EIX	6681	0.5
900	900 Sei	79→	D8EA	2120	D8EVX	2850	DR8EIX	6681	0.5
	TNT 899/S (Tornado Naked Tre)	08→	CR9E	6263			CR9EIX	3521	0.7
	Tornado Tre 900/903 RS	02→	CR9E	6263			CR9EIX	3521	0.7
	Tornado Tre 903	08→	CR9E	6263			CR9EIX	3521	0.7
1130	TNT 1130	04→	CR9E	6263			CR9EIX	3521	0.7
	TNT 1130 Titanium	06→	CR9E	6263			CR9EIX	3521	0.8
	TNT 1130 Sport Evo (Tornado Naked Tre)	07→	CR9E	6263			CR9EIX	3521	0.8
	TNT Café Racer 1130	01/06→	CR9E	6263			CR9EIX	3521	0.8
	Tornado Tre 1130	06→	CR9E	6263			CR9EIX	3521	0.7
	Tornado Tre K	06→	CR9E	6263			CR9EIX	3521	0.7
	Tre K Amazonas	07→	CR9E	6263			CR9EIX	3521	0.8

2 Wheel



CC	MODEL	DATE	STANDARD COPPER CORE	STOCK NUMBER	PLATINUM OR GOLD PALLADIUM	STOCK NUMBER	IRIDIUM	STOCK NUMBER	GAP MM
BETA / BETAMOTOR									
50	Ark (Air Cooled)	98→	BR7HS	4122			BR7HIX	7067	0.6
	Ark (Liquid Cooled)	97→	BR8HS	4322			BR8HIX	7001	0.7
	Eikon 50	99→	BR8HS	4322			BR8HIX	7001	0.7
	Enduro 50		BR10ES	4832			BR10EIX	6801	0.7
	Mini Cross 10/10, 12/13, 12/15 & Mini Trial		B7HS	5110			BR7HIX	7067	0.6
	Quadra	97→	BR7HS	4122			BR7HIX	7067	0.6
	R10		B7HS	5110			BR7HIX	7067	0.6
	R12		B7HS	5110			BR7HIX	7067	0.6
	Rev 50	03→	B9ES	2611	B9EVX	7254	BR9EIX	3981	0.5
	RR Enduro 50	98→	BR10ES	4832			BR10EIX	6801	0.7
	RR Enduro 50, Racing 50 (Euro 2 engine)	04→	BR9ES	5722			BR9EIX	3981	0.6
	RR 50 Motard	08→	BR9ES	5722			BR9EIX	3981	0.6
	Supermotard 50		BR10ES	4832			BR10EIX	6801	0.7
	Supermoto 50		BR10ES	4832			BR10EIX	6801	0.7
	Tempo		BR7HS	4122			BR7HIX	7067	0.6
Zero		B8ES	2411	B8EVX	7051	BR8EIX	5044	0.5	
70	Supermoto 72, Enduro 72				B10HVX	2940			0.6
80	EVO 80/Junior	09→	BR8ES	5422			BR8EIX	5044	0.6
	Rev 80	03→	B9ES	2611	B9EVX	7254	BR9EIX	3981	0.5
107	R107-4T		C7HSA	4629			CR7HIX	7544	0.7
125	125 E6G		B7HS	5110			BR7HIX	7067	0.5
	125 Enduro		B7HS	5110			BR7HIX	7067	0.5
	125 Trial		B6ES	7310					0.5
	Alp 4T 125	00→	DR8EA	7162	DR8EVX	6354	DR8EIX	6681	0.6
	Eikon 125	99→	DPR7EA-9	5129	DPR7EVX-9	7682	DPR7EIX-9	7803	0.9
	Euro 125		DR8EA	7162	DR8EVX	6354	DR8EIX	6681	0.6
	EVO 125 2T	09→	BR7ES	5122			BR7EIX	6664	0.6
	Minicross R 125 4T		C7HSA	4629			CR7HIX	7544	0.7
	RE 125 4T		CR7HSA	4549			CR7HIX	7544	0.6
	REV 3 125 Trials	00→07	BP7ES	2412	BP7EVX	7270	BPR7EIX	4055	0.6
	REV 3 125 Trials	08→	BR7ES	5122			BR7EIX	6664	0.7
	RR 125 4T Enduro / Motard		CR7HSA	4549			CR7HIX	7544	0.6
	Synt		B8ES	2411	B8EVX	7051	BR8EIX	5044	0.5
	TR32		B8ES	2411	B8EVX	7051	BR8EIX	5044	0.5
	TR34		B8ES	2411	B8EVX	7051	BR8EIX	5044	0.5
	TR35		B8ES	2411	B8EVX	7051	BR8EIX	5044	0.5
	Urban 125	08→	CR7HSA	4549			CR7HIX	7544	0.6
Zero		B8ES	2411	B8EVX	7051	BR8EIX	5044	0.5	
150	Eikon 150	99→	DPR7EA-9	5129	DPR7EVX-9	7682	DPR7EIX-9	7803	0.9
200	Alp 4T 200	00→	DR8EA	7162	DR8EVX	6354	DR8EIX	6681	0.6
	EVO 200 2T	09→	BR7ES	5122			BR7EIX	6664	0.6
	REV 3 200 Trials	00→07	BP7ES	2412	BP7EVX	7270	BPR7EIX	4055	0.6
	REV 3 200 Trials	08→	BR7ES	5122			BR7EIX	6664	0.7
	Techno 200 Trial →96	→96	BR8ES	5422			BR8EIX	5044	0.6
	Techno 200 Trial 96→	96→	BP7ES	2412	BP7EVX	7270	BPR7EIX	4055	0.6
Urban 200	08→	DR8EA	7162	DR8EVX	6354	DR8EIX	6681	0.6	
240	Super Trial		B8ES	2411	B8EVX	7051	BR8EIX	5044	0.5
	TR33		B6ES	7310					0.5
	Trial		B6ES	7310					0.5
250	Enduro		B7HS	5110			BR7HIX	7067	0.5
	EVO 250 2T	09→	BR7ES	5122			BR7EIX	6664	0.6
	EVO 250 4T	09→	CR7EB	4663			CR7EIX	7385	0.6
	REV 3 250 2T Trials	00→07	BP7ES	2412	BP7EVX	7270	BPR7EIX	4055	0.6
	REV 3 250 2T Trials	08→	BR7ES	5122			BR7EIX	6664	0.7
	REV 4T 250 Trials	07→	CR7EB	4663			CR7EIX	7385	0.6
	RR 250 4T		DCPR8E*	4339			DCR8EIX	3606	0.7
	Techno 250 Trial →96	→96	BR8ES	5422			BR8EIX	5044	0.6
	Techno 250 Trial 96→	96→	BP7ES	2412	BP7EVX	7270	BPR7EIX	4055	0.6
	TR32		B8ES	2411	B8EVX	7051	BR8EIX	5044	0.5
260	Synt		B8ES	2411	B8EVX	7051	BR8EIX	5044	0.5
	TR34		B8ES	2411	B8EVX	7051	BR8EIX	5044	0.5



* Please note DCPR8E 4339 has a removable terminal nut, whereas DCPR8E 4179 has a fixed terminal nut





CC	MODEL	DATE	STANDARD COPPER CORE	STOCK NUMBER	PLATINUM OR GOLD PALLADIUM	STOCK NUMBER	IRIDIUM	STOCK NUMBER	GAP MM
BETA / BETAMOTOR (CONTINUED)									
260	TR35		B8ES	2411	B8EVX	7051	BR8EIX	5044	0.5
	Zero Gara		B8ES	2411	B8EVX	7051	BR8EIX	5044	0.5
270	REV 3 270 Trials	00→07	BP7ES	2412	BP7EVX	7270	BPR7EIX	4055	0.6
	REV 3 270 Trials	08→	BR7ES	5122			BR7EIX	6664	0.7
	Techno 270 Trial →96	→96	BR8ES	5422			BR8EIX	5044	0.6
	Techno 270 Trial 96→	96→	BP7ES	2412	BP7EVX	7270	BPR7EIX	4055	0.6
290	EVO 290 2T	09→	BR7ES	5122			BR7EIX	6664	0.6
300	EVO 300 4T	09→	CR7EB	4663			CR7EIX	7385	0.6
350	Alp 4.0 (Suzuki eng.)		CR9EK	4548			CR9EIX	3521	0.6
	Euro 350	01→	CR9EK	4548			CR9EIX	3521	0.6
	Jonathan 350		CR9EK	4548			CR9EIX	3521	0.6
	M4 4T		CR9EK	4548			CR9EIX	3521	0.6
	Motard 4.0		CR9EK	4548			CR9EIX	3521	0.6
400	RR 400 4T		DCPR8E*	4339			DCR8EIX	3606	0.7
450	RR 450 4T		DCPR8E*	4339			DCR8EIX	3606	0.7
525	RR 525 4T		DCPR8E*	4339			DCR8EIX	3606	0.7

BIMOTA									
500	500 V-Due		BR9ES	5722			BR9EIX	3981	0.7
600	YB9 SRi		CR9E	6263			CR9EIX	3521	0.7
900	DB3 Mantra		DPR8EA-9	4929			DPR8EIX-9	2202	0.6
	DB4		DPR8EA-9	4929			DPR8EIX-9	2202	0.6
	Mantra		DPR7EA-9	5129	DPR7EVX-9	7682	DPR7EIX-9	7803	0.9
992	DB5	05→	DCPR8E*	4339			DCR8EIX	3606	0.9
	DB6 Delirio	06→	DCPR8E*	4339			DCR8EIX	3606	0.9
1000	Mono/Biposto		D8EA	2120	D8EVX	2850	DR8EIX	6681	0.6
	SB8R/S		CR9EK	4548			CR9EIX	3521	0.6
	YB11 Superleggera		DR8EA	7162	DR8EVX	6354	DR8EIX	6681	0.7
1078	DB5R/S	07→	DCPR8E*	4339			DCR8EIX	3606	0.9
	DB6R/S	08→	DCPR8E*	4339			DCR8EIX	3606	0.9
1098	DB7	09→	MAR10A-J	4706					0.8
1100	SB6/SB6R		CR9E	6263			CR9EIX	3521	0.7

BMW									
125	C1	00→04	CR8EB	7784			CR8EIX	4218	0.7
175	C1 200	01→04	CR8EB	7784			CR8EIX	4218	0.7
450	G450X	08→	CR9EKB	2305			CR9EIX	3521	0.7
	R45	78→	BP7ES	2412	BP7EVX	7270	BPR7EIX	4055	0.6
600	R60/7	→78	BP7ES	2412	BP7EVX	7270	BPR7EIX	4055	0.6
650	F650	94→99	D8EA	2120	D8EVX	2850	DR8EIX	6681	0.7
	F650ST Strada	97→99	D8EA	2120	D8EVX	2850	DR8EIX	6681	0.7
	F650GS/GSD	00→02	DR8EB	4855	DR8EVX	6354	DR8EIX	6681	0.7
	F650CS/GS/GS Dakar	02→05	DR8EB	4855	DR8EVX	6354	DR8EIX	6681	0.7
	F650GS/GS Dakar (Single cylinder twin spark models)	11/05→11/07	DR8EB	4855	DR8EVX	6354	DR8EIX	6681	0.7
	F650 Xchallenge	07→	DR8EB	4855	DR8EVX	6354	DR8EIX	6681	0.7
	G650 Xmoto / Xcountry	07→	DR8EB	4855	DR8EVX	6354	DR8EIX	6681	0.7
	R65	78→	BP7ES	2412	BP7EVX	7270	BPR7EIX	4055	0.6
	R65/GS		BP6ES	7811	BP6EVX	5832	BPR6EIX	6637	0.6
	R65LS	81→85	BP7ES	2412	BP7EVX	7270	BPR7EIX	4055	0.6
750	K75	85→97	D7EA	7912					0.6
	R75/7		BP7ES	2412	BP7EVX	7270	BPR7EIX	4055	0.6
800	F650GS (Twin cylinder 798cc)	11/07→	DCPR8E*	4339			DCR8EIX	3606	0.7
	F800S/ST	05/06→	DCPR8E*	4339			DCR8EIX	3606	0.7
	F800GS	11/07→	DCPR8E*	4339			DCR8EIX	3606	0.7
	F800R	05/09→	DCPR8E*	4339			DCR8EIX	3606	0.7
	R80GS	80→94	BP6ES	7811	BP6EVX	5832	BPR6EIX	6637	0.6
	R80RT	82→95	BP6ES	7811	BP6EVX	5832	BPR6EIX	6637	0.6
	R80ST	82→85	BP6ES	7811	BP6EVX	5832	BPR6EIX	6637	0.6
	R80TIC		BP6ES	7811	BP6EVX	5832	BPR6EIX	6637	0.6



* Please note DCPR8E 4339 has a removable terminal nut, whereas DCPR8E 4179 has a fixed terminal nut



2 Wheel



CC	MODEL	DATE	STANDARD COPPER CORE	STOCK NUMBER	PLATINUM OR GOLD PALLADIUM	STOCK NUMBER	IRIDIUM	STOCK NUMBER	GAP MM
BMW (CONTINUED)									
850	R850C, R850GS, R850R →04/1999	→04/99	BCPR7ET	2164			BKR7EIX	2667	0.8
	R850C, R850GS, R850R 04/1999→	04/99→	BKR7EKC	7354			BKR7EIX	2667	0.8
900	R90/6		BP6ES	7811	BP6EVX	5832	BPR6EIX	6637	0.6
	R90S		BP7ES	2412	BP7EVX	7270	BPR7EIX	4055	0.6
1000	K1	89→93	D7EA	7912					0.6
	K100	83→	D7EA	7912					0.6
	K100RS 16 Valve 1991→	91→	D7EA	7912					0.6
	R100/7		BP7ES	2412	BP7EVX	7270	BPR7EIX	4055	0.6
	R100/R100R		BP7ES	2412	BP7EVX	7270	BPR7EIX	4055	0.6
	R100RS/RT→1982	→82	BP7ES	2412	BP7EVX	7270	BPR7EIX	4055	0.6
	R100GS/RS/RT 1985→	85→	BP6ES	7811	BP6EVX	5832	BPR6EIX	6637	0.6
1100	K1100LT/SE	92→	DR7EA	7839					0.6
	K1100RS	92→	DR7EA	7839					0.6
	R1100GS →04/1999	→04/99	BCPR7ET	2164			BKR7EIX	2667	0.8
	R1100GS 04/1999→	04/99→	BKR7EKC	7354			BKR7EIX	2667	0.8
	R1100R 1995→	95→	BCPR7ET	2164			BKR7EIX	2667	0.8
	R1100RS/RT	93→	BCPR7ET	2164			BKR7EIX	2667	0.8
	R1100S→04/1999	→04/99	BCPR7ET	2164			BKR7EIX	2667	0.8
	R1100S 04/1999→	04/99→03	BKR7EKC	7354			BKR7EIX	2667	0.8
1130	R1150GS /R/RS/RT	99→03	BKR7EKC	7354			BKR7EIX	2667	0.8
	R1150GS/R/S (Twin Spark Models)	Ø14mm plug Ø12mm plug	BKR7EKC DCPR8EKC	7354 7168			BKR7EIX DCPR8EIX	2667 6546	0.8 0.8
1157	K1200R	01/05→					KR9CI	7795	0.8
	K1200R Sport	11/07→					KR9CI	7795	0.8
	K1200S	09/04→					KR9CI	7795	0.8
1170	HP2 Enduro (Twin Spark Models)	Ø14mm plug Ø12mm plug	BKR7EKC DCPR8EKC	7354 7168			BKR7EIX DCPR8EIX	2667 6546	0.8 0.8
	HP2 Megamoto (Twin Spark Models)	Ø12mm plug	DCPR8EKC	7168			DCPR8EIX	6546	0.8
	HP2 Sport		MAR9A-J	6869					0.8
	K1200GT	03→11/05	DCPR7E	3932	DCPR7EVX	1179	DCR7EIX	3605	0.8
	K1200GT	01/06→					KR9CI	7795	0.8
	K1200RS/LT	97→	DCPR7E	3932	DCPR7EVX	1179	DCR7EIX	3605	0.8
	R1200C Classic, Avantgarde, Independent	97→	BKR7EKC	7354			BKR7EIX	2667	0.8
	R1200GS Twinspark	04→	DCPR8EKC	7168			DCPR8EIX	6546	0.8
	R1200R Twinspark	06→	DCPR8EKC	7168			DCPR8EIX	6546	0.8
	R1200RT Twinspark	03/05→	DCPR8EKC	7168			DCPR8EIX	6546	0.8
	R1200S Twinspark	06→	DCPR8EKC	7168			DCPR8EIX	6546	0.8
R1200ST Twinspark	03/05→	DCPR8EKC	7168			DCPR8EIX	6546	0.8	
1293	K1300GT	09→					KR9CI	7795	0.8
	K1300R	09→					KR9CI	7795	0.8
	K1300S	09→					KR9CI	7795	0.8

BSA									
50	Beaver, Brigand, Boxer		B6HS	4510			BR6HIX	3419	0.5
	ER1K, Junior, Easy Rider ER1/ER2	80→	BP6ES	7811	BP6EVX	5832	BPR6EIX	6637	0.5
	NVT Models: Easy Rider ER1/2/4, Ranger	80→	BP6ES	7811	BP6EVX	5832	BPR6EIX	6637	0.5
125	Rambler 125, Tracker 125	79→	B9ES	2611	B9EVX	7254	BR9EIX	3981	0.5
175	Rambler 175, Tracker 175, Trials 175	79→	B8ES	2411	B8EVX	7051	BR8EIX	5044	0.5
400	Gold SR 400	99→	BPR6ES	7822			BPR6EIX	6637	0.7
500	Gold SR 500	99→	BPR7ES	2023			BPR7EIX	4055	0.7
	Victor, B50 Moto-Cross		B8EG	3430	B8EGV	5627	BR8EIX	5044	0.5

BUELL									
984	Firebolt XB9R	02→	DCPR9E	2641	DCPR9EVX	6436	DCPR9EIX	2316	0.9
	Lightning CityX XB9SX	05→	DCPR9E	2641	DCPR9EVX	6436	DCPR9EIX	2316	0.9
	Lightning XB9S	02→	DCPR9E	2641	DCPR9EVX	6436	DCPR9EIX	2316	0.9
	XB9X (City X)	09→	DCPR9E	2641	DCPR9EVX	6436	DCPR9EIX	2316	0.9
1125	1125R	08→	CR9EKB	2305			CR9EIX	3521	0.8
	1125CR (Café Racer)	09→	CR9EKB	2305			CR9EIX	3521	0.8



CC	MODEL	DATE	STANDARD COPPER CORE	STOCK NUMBER	PLATINUM OR GOLD PALLADIUM	STOCK NUMBER	IRIDIUM	STOCK NUMBER	GAP MM
BUELL (CONTINUED)									
1200	Firebolt XB12R	03→	DCPR9E	2641	DCPR9EVX	6436	DCPR9EIX	2316	0.9
	Lightning XB12S/Ss	04→	DCPR9E	2641	DCPR9EVX	6436	DCPR9EIX	2316	0.9
	Lightning XB12Scg	06→	DCPR9E	2641	DCPR9EVX	6436	DCPR9EIX	2316	0.9
	Lightning XB12STT	07→	DCPR9E	2641	DCPR9EVX	6436	DCPR9EIX	2316	0.9
	M2 Cyclone	97→03	DCPR9E	2641	DCPR9EVX	6436	DCPR9EIX	2316	0.9
	S1 Lightning	97→99	DCPR9E	2641	DCPR9EVX	6436	DCPR9EIX	2316	0.9
	S1W White Lightning	98	DCPR9E	2641	DCPR9EVX	6436	DCPR9EIX	2316	0.9
	S3 Thunderbolt	97→99	DCPR9E	2641	DCPR9EVX	6436	DCPR9EIX	2316	0.9
	Ulysses XB12X	05→	DCPR9E	2641	DCPR9EVX	6436	DCPR9EIX	2316	0.9
	X1 Lightning	99→03	DCPR9E	2641	DCPR9EVX	6436	DCPR9EIX	2316	0.9

CAGIVA									
50	City 50	94→	BPR8HS	3725			BPR8HIX	6742	0.5
	Mito 50 (Standard)	98→	B9ES	2611	B9EVX	7254	BR9EIX	3981	0.5
	Prima 50	92→	B8ES	2411	B8EVX	7051	BR8EIX	5044	0.5
	Supercity 50	92→	B8ES	2411	B8EVX	7051	BR8EIX	5044	0.5
	W4 50	92→	B8ES	2411	B8EVX	7051	BR8EIX	5044	0.5
75	Prima 80	92→	B8ES	2411	B8EVX	7051	BR8EIX	5044	0.5
	Supercity 80	92→	B8ES	2411	B8EVX	7051	BR8EIX	5044	0.5
	W4 80	92→	B8ES	2411	B8EVX	7051	BR8EIX	5044	0.5
125	Blues 125	91→93			B95EGV	2145			0.5
	Freccia C12/C12R		B9ES	2611	B9EVX	7254	BR9EIX	3981	0.5
	K7				B95EGV	2145			0.5
	Mito 125	91→	BR9EG	3230			BR9EIX	3981	0.6
	Mito 125 (Race)				B95EGV	2145			0.7
	Mito (Le Lawson)	92→			B95EGV	2145			0.5
	Mito 525SP	04/08→	BR9EG	3230			BR9EIX	3981	0.6
	Planet 125	98→			B95EGV	2145			0.6
	Raptor (2-Stroke)	04→	BR9EG	3230			BR9EIX	3981	0.6
	Roadster 125	92→	B9ES	2611	B9EVX	7254	BR9EIX	3981	0.6
	Super City 125	→02/95	B9EG	3530	B9EGV	5827	BR9EIX	3981	0.5
	Super City 125	06/98→			B95EGV	2145			0.6
	W8 125	→12/92	B9EG	3530	B9EGV	5827	BR9EIX	3981	0.6
	W8 125	07/98→	B9ES	2611	B9EVX	7254	BR9EIX	3981	0.6
WMX 125		B10EG	3630	B10EGV	5927	BR10EIX	6801	0.5	
WSXT 125	82→	B9EG	3530	B9EGV	5827	BR9EIX	3981	0.5	
250	SST 250	81→	B8ES	2411	B8EVX	7051	BR8EIX	5044	0.5
	WMX 250				B95EGV	2145			0.5
350	Indiana 350		BP7HS	5111			BPR7HIX	5944	0.5
	W12 350	93→	DPR8EA-9	4929			DPR8EIX-9	2202	0.6
500	Canyon 500	02/98→	DCPR8E*	4179			DCR8EIX	3606	0.6
	River 500	99→	DCPR8E*	4179			DCR8EIX	3606	0.6
600	Canyon 600	→03/97	BCP7ES	5030	BCP7EVX	7681			0.8
	River 600	95→	BCP7ES	5030	BCP7EVX	7681			0.8
	W16 600	→95	C7E	5096			CR7EIX	7385	0.6
	W16 600	95→	BCP7ES	5030	BCP7EVX	7681			0.8
650	Alazzurra 650	85→88	BP7HS	5111			BPR7HIX	5944	0.5
	Indiana 650		BP7HS	5111			BPR7HIX	5944	0.5
	Raptor	00→	CR8E	1275			CR8EIX	4218	0.7
	V Raptor	00→	CR8E	1275			CR8EIX	4218	0.7
750	Elefant 750	87→	DPR8EA-9	4929			DPR8EIX-9	2202	0.6
	Indiana 750		BP7HS	5111			BPR7HIX	5944	0.5
900	900GT		DR9EA	3437	DR9EVX	6361	DR9EIX	4772	0.5
	900 i.e.		DR9EA	3437	DR9EVX	6361	DR9EIX	4772	0.5
	Elefant 900	91→	DPR8EA-9	4929			DPR8EIX-9	2202	0.9
	Gran Canyon	99→	DCPR8E*	4179			DCR8EIX	3606	0.6
1000	Navigator/T	00→	CR8EK	3478			CR8EIX	4218	0.6
	Raptor	00→	CR8EK	3478			CR8EIX	4218	0.7
	V Raptor	00→	CR8EK	3478			CR8EIX	4218	0.7
	Xtra Raptor	02→	CR8EK	3478			CR8EIX	4218	0.7



* Please note DCPR8E 4339 has a removable terminal nut, whereas DCPR8E 4179 has a fixed terminal nut



2 Wheel



CC	MODEL	DATE	STANDARD COPPER CORE	STOCK NUMBER	PLATINUM OR GOLD PALLADIUM	STOCK NUMBER	IRIDIUM	STOCK NUMBER	GAP MM
CCM (ARMSTRONG-CCM)									
125	CMX 125 L/C 1983→85	83→85	B9EG	3530	B9EGV	5827	BR9EIX	3981	0.5
	Moto-X Hiro 125 1979→80	79→80	B10EG	3630	B10EGV	5927	BR10EIX	6801	0.5
240	Trials CMT 240		BP5ES	6511			BPR5EIX	6597	0.5
250	CMT 250 Trials		BP5ES	6511			BPR5EIX	6597	0.5
	CMX 250 1982	82	B8EG	3430	B8EGV	5627	BR8EIX	5044	0.5
	CMX 250, 250 L/C 1983→85	83→85	B9EG	3530	B9EGV	5827	BR9EIX	3981	0.5
	Moto-X Hiro 250 1979→81	79→81	B9EG	3530	B9EGV	5827	BR9EIX	3981	0.5
310	CMT 310 Trials		BP5ES	6511			BPR5EIX	6597	0.5
320	CMT 320 Trials		BP5ES	6511			BPR5EIX	6597	0.5
350	350 Trials	78	B6ES	7310					0.5
	CMT 350 Trials		BP5ES	6511			BPR5EIX	6597	0.5
400	404E/DS	03→	CR8E	1275			CR8EIX	4218	0.7
	404XC-Trail		CR8E	1275			CR8EIX	4218	0.7
	FT35	05→	CR8E	1275			CR8EIX	4218	0.7
	R35	06→	CR8E	1275			CR8EIX	4218	0.7
	SR40	07→	CR8E	1275			CR8EIX	4218	0.7
434	R35 Factory Big Bore Conversion	06→	CR8E	1275			CR8EIX	4218	0.7
450	CMX 450 1982→	82→	B8EG	3430	B8EGV	5627	BR8EIX	5044	0.5
490	CMX 490		B8EG	3430	B8EGV	5627	BR8EIX	5044	0.5
500	CMX 500 4-Stroke		D8EA	2120	D8EVX	2850	DR8EIX	6681	0.5
	Moto-X 4-Stroke, 2 valve models 1972→79	72→79	B8EG	3430	B8EGV	5627	BR8EIX	5044	0.5
	Moto-X 4-Stroke, 4 valve models 1979→81	79→81					CR8EIX	4218	0.5
	MTT 500		D8EA	2120	D8EVX	2850	DR8EIX	6681	0.5
560	CCM 560		D8EA	2120	D8EVX	2850	DR8EIX	6681	0.5
	CMX 560 4-Stroke		D8EA	2120	D8EVX	2850	DR8EIX	6681	0.5
600	604E Sport & Supermoto		D8EA	2120	D8EVX	2850	DR8EIX	6681	0.5
	604R / RS / R30		D8EA	2120	D8EVX	2850	DR8EIX	6681	0.5
640	640 RS (Rotax Engine)		D8EA	2120	D8EVX	2850	DR8EIX	6681	0.5
644	644 (Suzuki Engine)	02→	CR10E	6264			CR10EIX	6482	0.7
	R30 (Suzuki Engine)	05→	CR10E	6264			CR10EIX	6482	0.7
710	R30 (Suzuki Engine)	05→	CR10E	6264			CR10EIX	6482	0.7

COSSACK

350	Jupiter, Planeta		BR6HS	3922			BR6HIX	3419	0.6
650	Dnepr, Ural		BR6HS	3922			BR6HIX	3419	0.6

CPI

50	Aragon 50	06→	BR7ES	5122			BR7EIX	6664	0.7
	Aragon GP50	06→	BR7ES	5122			BR7EIX	6664	0.7
	Formula R		BR7HS	4122			BR7HIX	7067	0.7
	GTR 50	05→	BR10EG	3830			BR10EIX	6801	0.6
	GTR 50	03→	BR7HS	4122			BR7HIX	7067	0.7
	GTS 50	03→	BR7HS	4122			BR7HIX	7067	0.7
	GTS 50	05→	BR10EG	3830			BR10EIX	6801	0.6
	Hussar 50, Mars JP50, Baby J 50 (Euro 1 Engine)		BR8HSA	5539			BPR8HIX	6742	0.6
	Hussar 50 (Euro 2 Engine)	03→	BR7ES	5122			BR7EIX	6664	0.7
	Oliver 50 (Euro 2 Engine)	03→	BR7ES	5122			BR7EIX	6664	0.7
	Popcorn 50 (Euro 2 Engine)	03→	BR7ES	5122			BR7EIX	6664	0.7
	Supercross 50 (Euro 1 Engine)		BR7HS	4122			BR7HIX	7067	0.7
	Supercross 50 (Euro 2 engine)	03→	BR7ES	5122			BR7EIX	6664	0.7
	Supermoto 50 (Euro 1 Engine)		BR7HS	4122			BR7HIX	7067	0.7
	Supermoto 50 (Euro 2 Engine)	03→	BR7ES	5122			BR7EIX	6664	0.7
	125	GTS 125		BR7HS	4122			BR7HIX	7067
Hussar JU 125		04→	CR7HSA	4549			CR7HIX	7544	0.6
QT4A ARN 125			CR7HSA	4549			CR7HIX	7544	0.6
X-Large 125			BR7HS	4122			BR7HIX	7067	0.7
150	GTS 150		BR7HS	4122			BR7HIX	7067	0.7
	X-Large 150		BR7HS	4122			BR7HIX	7067	0.7
200	GTS 200		BR7HS	4122			BR7HIX	7067	0.7
	X-Large 200		BR7HS	4122			BR7HIX	7067	0.7



CC	MODEL	DATE	STANDARD COPPER CORE	STOCK NUMBER	PLATINUM OR GOLD PALLADIUM	STOCK NUMBER	IRIDIUM	STOCK NUMBER	GAP MM
DAELIM									
50	Cordi	04→	BPR6HS	7022			BPR6HIX	4085	0.6
	E Five	03→	B8HS	5510	B8HVX	2634	BR8HIX	7001	0.7
	Message 49	98→	BR8HSA	5539			BPR8HIX	6742	0.7
	S Five	02→	B8HS	5510	B8HVX	2634	BR8HIX	7001	0.7
100	Delpino 100	99→	B8HS	5510	B8HVX	2634	BR8HIX	7001	0.7
110	Citi Ace 110	03→	C7HSA	4629			CR7HIX	7544	0.7
125	Altino NF125ES	03→	CR8EH-9	5666			CR8EHIX-9	3797	0.9
	History 125	04→	CR8EH-9	5666			CR8EHIX-9	3797	0.9
	NS125 Trans Eagle	98→	CR8EH-9	5666			CR8EHIX-9	3797	0.9
	Roadwin	04→	CR8EH-9	5666			CR8EHIX-9	3797	0.9
	VEE125		CR8EH-9	5666			CR8EHIX-9	3797	0.9
	VL125 Daystar		CR8EH-9	5666			CR8EHIX-9	3797	0.9
	VS125	97→	CR8EH-9	5666			CR8EHIX-9	3797	0.9

DERBI									
50	Atlantis 50 4-Stroke	04→	CR8EB	7784			CR8EIX	4218	0.7
	Atlantis 50 Air Cooled (12.7mm Thread Reach)	99→02	B8HS	5510	B8HVX	2634	BR8HIX	7001	0.5
	Atlantis 50 Air Cooled (19mm Thread Reach)	03→	BR9ES	5722			BR9EIX	3981	0.6
	Atlantis 50 Liquid Cooled	00→	BR9ES	5722			BR9EIX	3981	0.6
	Black Devil	03→	B8ES	2411	B8EVX	7051	BR8EIX	5044	0.6
	Black Edition	03→	B8ES	2411	B8EVX	7051	BR8EIX	5044	0.6
	Black Mini	03→	CR9E	6263			CR9EIX	3521	0.6
	Dirt Boy, Dirt Kid	03→	CR9E	6263			CR9EIX	3521	0.6
	DRD 50 Supermoto (2002)	02→	B8ES	2411	B8EVX	7051	BR8EIX	5044	0.5
	GP1	03→	BR10ES	4832			BR10EIX	6801	0.7
	GPR 50-R	97→	B8ES	2411	B8EVX	7051	BR8EIX	5044	0.5
	GPR 50 (Standard power)	02→	B8ES	2411	B8EVX	7051	BR8EIX	5044	0.5
	GPR 50 (Full power)	02→	B9ES	2611	B9EVX	7254	BR9EIX	3981	0.6
	Hunter	96→98	B8HS	5510	B8HVX	2634	BR8HIX	7001	0.5
	Predator LC	98→	B8ES	2411	B8EVX	7051	BR8EIX	5044	0.5
	Senda 50 / R / SM (Standard power)	95→	B8ES	2411	B8EVX	7051	BR8EIX	5044	0.5
	Senda 50 / R / SM (Full power)	95→	B9ES	2611	B9EVX	7254	BR9EIX	3981	0.6
Vamos	95→97	B8HS	5510	B8HVX	2634	BR8HIX	7001	0.5	
85	Atlantis 100	00→	BR9ES	5722			BR9EIX	3981	0.7
	Senda 100	97→	B9ES	2611	B9EVX	7254	BR9EIX	3981	0.6
125	Boulevard 125 4T	03→	CR7EB	4663			CR7EIX	7385	0.6
	Cross City 125	07→	D8EA	2120	D8EVX	2850	DR8EIX	6681	0.8
	GP1 125	06→	CR9EB	6955			CR9EIX	3521	0.6
	GPR 125 (Yamaha engine)	04→	BR8ES	5422			BR8EIX	5044	0.7
	HDR Cabriolet 125	00→	CR7E	4578			CR7EIX	7385	0.5
	Senda 125 4T (Honda engine)	03→	DPR8EA-9	4929			DPR8EIX-9	2202	0.7
	Senda Baja R 125	07→	D8EA	2120	D8EVX	2850	DR8EIX	6681	0.8
150	Boulevard 150 4T	03→	CR7EB	4663			CR7EIX	7385	0.6
250	GP1 250	06→	CR9EB	6955			CR9EIX	3521	0.6
660	Mulhacen 659 / Café	06→	CR7E	4578			CR7EIX	7385	0.5

DUCATI									
250	250 Desmo/Monza/Sebring		B6HS	4510			BR6HIX	3419	0.5
350	350 Desmo/Sebring		B6HS	4510			BR6HIX	3419	0.5
	350 Sport	91→	BP7HS	5111			BPR7HIX	5944	0.6
400	400 SS/Junior	91→94	BP7HS	5111			BPR7HIX	5944	0.6
450	450 Desmo/Sebring		B6HS	4510			BR6HIX	3419	0.5
500	500 Desmo	78→83	B6HS	4510			BR6HIX	3419	0.5
	500 Pantah	80→84	BP7HS	5111			BPR7HIX	5944	0.6
600	600 Monster/Monster S/Monster Dark						DCR8EIX	3606	0.7
	600 Pantah	80→85	BP7HS	5111			BPR7HIX	5944	0.6
	600 SS	→94	DCPR8E*	4339			DCR8EIX	3606	0.7
	600 SS	94→98	DCPR8E*	4339			DCR8EIX	3606	0.7
620	620 i.e., S i.e. & i.e. Dark	02→	DCPR8E*	4339			DCR8EIX	3606	0.7
	Multistrada 620	04→	DCPR8E*	4339			DCR8EIX	3606	0.7



* Please note DCPR8E 4339 has a removable terminal nut, whereas DCPR8E 4179 has a fixed terminal nut





CC	MODEL	DATE	STANDARD COPPER CORE	STOCK NUMBER	PLATINUM OR GOLD PALLADIUM	STOCK NUMBER	IRIDIUM	STOCK NUMBER	GAP MM
DUCATI (CONTINUED)									
650	Indiana 650	86→88	BP7HS	5111			BPR7HIX	5944	0.6
695	Monster 695	06→08	DCPR8E*	4339			DCR8EIX	3606	0.7
696	Monster 696	08→	DCPR8E*	4339			DCR8EIX	3606	0.7
748	748, 748 Biposto	95→04					DCR9EIX	6650	0.6
	Dark	04→06	CR9EB	6955			CR9EIX	3521	0.6
	748 R	00→04	R2349-10	6839					0.6
	748 S	00→04					DCR9EIX	6650	0.6
	748 SP	95→98	R2349-10	6839					0.6
	748 SPS	98→00	R2349-10	6839					0.6
	749	02→06	CR9EB	6955			CR9EIX	3521	0.6
	749, R, S	03→06	CR9EB	6955			CR9EIX	3521	0.6
750	750 F1 1986 →1988	86→88	BP7HS	5111			BPR7HIX	5944	0.6
	750 F1 1989 →	89→	DCPR8E*	4339			DCR8EIX	3606	0.7
	750 GT		B7HS	5110			BR7HIX	7067	0.5
	750 Monster	96→	DCPR8E*	4339			DCR8EIX	3606	0.7
	750 Montjuich		BP7HS	5111			BPR7HIX	5944	0.6
	750 Paso	86→90	DCPR8E*	4339			DCR8EIX	3606	0.7
	750 Sport		DCPR8E*	4339			DCR8EIX	3606	0.7
	750 SS →1990	→90	B7HS	5110			BR7HIX	7067	0.5
	750 SS 1991→	91→	DCPR8E*	4339			DCR8EIX	3606	0.7
	750 SS i.e.	98→	DCPR8E*	4339			DCR8EIX	3606	0.7
803	800 Sport	03→	DCPR8E*	4339			DCR8EIX	3606	0.7
	800 i.e.	03→	DCPR8E*	4339			DCR8EIX	3606	0.7
	S2R 800		DCPR8E*	4339			DCR8EIX	3606	0.7
	SS 800	03→	DCPR8E*	4339			DCR8EIX	3606	0.7
848	850	08→	MAR10A-J	4706					0.8
851	851				D9EVX	2834	DR9EIX	4772	0.6
	851 Strada 1989 →92	89→92			D9EVX	2834	DR9EIX	4772	0.6
860	860 GT/GTS		B5HS	4210					0.6
888	888 SP (Sport Production)	90→93					DCR9EIX	6650	0.8
	888 Strada				D9EVX	2834	DR9EIX	4772	0.6
	888 Strada 94→	94→	DR9EA	3437	DR9EVX	6361	DR9EIX	4772	0.6
900	900 Darmah SS/SD		B6HS	4510			BR6HIX	3419	0.5
	900 i.e. Monster/Monster Dark	99→	DCPR8E*	4339			DCR8EIX	3606	0.9
	900 Injection		DCPR8E*	4339			DCR8EIX	3606	0.9
	900 Monster/Monster S	97→	DCPR8E*	4339			DCR8EIX	3606	0.9
	900 SS 1991→	91→	DCPR8E*	4339			DCR8EIX	3606	0.9
	900 SS/SSD/S2/Hailwood Replica	79→	B7HS	5110			BR7HIX	7067	0.6
	900 Superlight	92→	DCPR8E*	4339			DCR8EIX	3606	0.9
	900 Supersport/ FE	97→	DCPR8E*	4339			DCR8EIX	3606	0.9
	906 Paso	88→94	DCPR8E*	4339			DCR8EIX	3606	0.9
	907 I.E.	91→	DCPR8E*	4339			DCR8EIX	3606	0.9
916	916 (All models except SP)	94→					DCR9EIX	6650	0.8
	916 SP	94→	R2349-10	6839					0.6
	916 SPS Fogarty Replica	98→	R2349-10	6839					0.6
	S4 Monster	01→					DCR9EIX	6650	0.8
	ST4	98→03					DCR9EIX	6650	0.8
944	ST2	97→03					DCR9EIX	6650	0.8
989	Desmosedici RR	07→	MAR10A-J	4706					0.8
992	GT1000	06→	DCPR8E*	4339			DCR8EIX	3606	0.9
	Monster 1000 i.e.	03→	DCPR8E*	4339			DCR8EIX	3606	0.9
	Multistrada 1000DS, MTS 1000DS	03→	DCPR8E*	4339			DCR8EIX	3606	0.9
	Paul Smart 1000 Limited Edition	05→	DCPR8E*	4339			DCR8EIX	3606	0.9
	Monster S2R/Dark 1000	10/05→	DCPR8E*	4339			DCR8EIX	3606	0.9
	Sport 1000	05→	DCPR8E*	4339			DCR8EIX	3606	0.9
	SS 1000 DS	03→06	DCPR8E*	4339			DCR8EIX	3606	0.9
	ST3	03→07	CR9EB	6955			CR9EIX	3521	0.6
996	996 B/S, Biposto	98→					DCR9EIX	6650	0.8
	996 S	00→02					DCR9EIX	6650	0.8
	996 SPS	97→02	R2349-10	6839					0.6
	S4R Monster	03→06					DCR9EIX	6650	0.8
	ST4S	00→					DCR9EIX	6650	0.8



* Please note DCPR8E 4339 has a removable terminal nut, whereas DCPR8E 4179 has a fixed terminal nut





CC	MODEL	DATE	STANDARD COPPER CORE	STOCK NUMBER	PLATINUM OR GOLD PALLADIUM	STOCK NUMBER	IRIDIUM	STOCK NUMBER	GAP MM
DUCATI (CONTINUED)									
998	996 R	00→02	CR9EB	6955			CR9EIX	3521	0.6
	998 Biposto, R, S	01→	CR9EB	6955			CR9EIX	3521	0.6
	998 Matrix	03	CR9EB	6955			CR9EIX	3521	0.6
	999, R, S	02→06	CR9EB	6955			CR9EIX	3521	0.6
	S4RS Monster	06→08	CR9EB	6955			CR9EIX	3521	0.6
	S4R Monster	07→	CR9EB	6955			CR9EIX	3521	0.6
1078	Hypermotard/S	07→	DCPR8E*	4339			DCR8EIX	3606	0.9
	Monster 1100/S	09→	DCPR8E*	4339			DCR8EIX	3606	0.9
	Multistrada 1100/S	06→	DCPR8E*	4339			DCR8EIX	3606	0.9
1098	1098, 1098S / Tricolore	07→	MAR10A-J	4706					0.8
	Streetfighter	09→	MAR10A-J	4706					0.8
1198	1098R (Including Bayliss LE)	08→	MAR10A-J	4706					0.8
	1198/S	09→	MAR10A-J	4706					0.8

FANTIC									
50	Gran Turismo, Lei 50, Issimo (all models)		B6HS	4510			BR6HIX	3419	0.5
	Trial 50		B7HS	5110			BR7HIX	7067	0.5
80	Caballero 80		B8EG	3430	B8EGV	5627	BR8EIX	5044	0.5
	Enduro 80		B8EG	3430	B8EGV	5627	BR8EIX	5044	0.5
	RSX 80		B8EG	3430	B8EGV	5627	BR8EIX	5044	0.5
	Section (1995)	95→97	BCP7ES	5030	BCP7EVX	7681			0.5
125	Caballero 125		B9EG	3530	B9EGV	5827	BR9EIX	3981	0.5
	Cross 125		B9EG	3530	B9EGV	5827	BR9EIX	3981	0.5
	Professional 125		B6HS	4510			BR6HIX	3419	0.5
	RSX 125		B9EG	3530	B9EGV	5827	BR9EIX	3981	0.5
	Trial 125		B6HS	4510			BR6HIX	3419	0.5
160	TX160		B8EG	3430	B8EGV	5627	BR8EIX	5044	0.5
175	Enduro 175		B8EG	3430	B8EGV	5627	BR8EIX	5044	0.5
200	Trial 200		B6HS	4510			BR6HIX	3419	0.5
240	Trial 240		B6HS	4510			BR6HIX	3419	0.5
250	K Roo 1991→1994	91→94	BL-6H	6921					0.5
	Section (1995)	95→97	BCP7ES	5030	BCP7EVX	7681			0.5
	TX250		B8EG	3430	B8EGV	5627	BR8EIX	5044	0.5
260	TX260		B8EG	3430	B8EGV	5627	BR8EIX	5044	0.5
300	Professional 300		B8EG	3430	B8EGV	5627	BR8EIX	5044	0.5
330	TX330		B8EG	3430	B8EGV	5627	BR8EIX	5044	0.5

GAS GAS									
50	Contact, Endurocross		B8HS	5510	B8HVX	2634	BR8HIX	7001	0.5
	EC 50 Boy (12.7mm Thread Reach)		B8HS	5510	B8HVX	2634	BR8HIX	7001	0.5
	EC Boy, Rookie 50 (19mm Thread Reach)	04→	B9ES	2611	B9EVX	7254	BR9EIX	3981	0.6
	SM 50 Supermotard	04→	B9ES	2611	B9EVX	7254	BR9EIX	3981	0.6
	TXT Boy		BPR5ES	7422			BPR5EIX	6597	0.5
65	MC65	06→	BR10ES	4832			BR10EIX	6801	0.7
75	Husqvarna (TM)		B10EG	3630	B10EGV	5927	BR10EIX	6801	0.5
80	TXT 80		BPR5ES	7422			BPR5EIX	6597	0.5
125	Contact T12		BP5ES	6511			BPR5EIX	6597	0.5
	EC 125 Endurocross	97→	B9EG	3530	B9EGV	5827	BR9EIX	3981	0.7
	Enduro 125 (2002 models)	02→	BR8EG	3130			BR8EIX	5044	0.5
	Endurocross TT 125, Cross TT125				B10EGV	5927	BR10EIX	6801	0.5
	GT12 Watercooled		BP5ES	6511			BPR5EIX	6597	0.5
	Husqvarna (TM)		B10EG	3630	B10EGV	5927	BR10EIX	6801	0.5
	Pampera 125		BPR5ES	7422			BPR5EIX	6597	0.5
	Trial 125		BP5ES	6511			BPR5EIX	6597	0.5
TX,TXT 125	99→	BPR5ES	7422			BPR5EIX	6597	0.5	
143	Contact T16		BP5ES	6511			BPR5EIX	6597	0.5
160	GT16 Watercooled		BP5ES	6511			BPR5EIX	6597	0.5
200	EC 200 Endurocross	99→			B10EGV	5927	BR10EIX	6801	0.6
	EC 200 Endurocross (2002 models)	02→	BR8EG	3130			BR8EIX	5044	0.5



* Please note DCPR8E 4339 has a removable terminal nut, whereas DCPR8E 4179 has a fixed terminal nut





CC	MODEL	DATE	STANDARD COPPER CORE	STOCK NUMBER	PLATINUM OR GOLD PALLADIUM	STOCK NUMBER	IRIDIUM	STOCK NUMBER	GAP MM
GAS GAS (CONTINUED)									
200	Trial 200		BP5ES	6511			BPR5EIX	6597	0.5
	TX,TXT 200	99→	BPR5ES	7422			BPR5EIX	6597	0.5
238	Contact JT25		BP5ES	6511			BPR5EIX	6597	0.5
249	TX,TXT 249	99→	BPR5ES	7422			BPR5EIX	6597	0.5
250	Delta 25 GT		BP5ES	6511			BPR5EIX	6597	0.5
	EC 250 Endurocross	97→	B8EG	3430	B8EGV	5627	BR8EIX	5044	0.5
	Enduro 250 (2002 models)	02→	BR8EG	3130			BR8EIX	5044	0.5
	Endurocross 250				B10EGV	5927	BR10EIX	6801	0.5
	Husqvarna (TM)		B10EG	3630	B10EGV	5927	BR10EIX	6801	0.5
	Pampera 250		BPR5ES	7422			BPR5EIX	6597	0.5
	Supermotard SM 250		BR8EG	3130			BR8EIX	5044	0.5
	Trial 250 (Air & Water Cooled Models)		BP5ES	6511			BPR5EIX	6597	0.5
270	TX,TXT 270		BP5ES	6511			BPR5EIX	6597	0.5
280	Pampera 280		BPR5ES	7422			BPR5EIX	6597	0.5
	Trial 280		BP5ES	6511			BPR5EIX	6597	0.5
	TX,TXT 280		BPR5ES	7422			BPR5EIX	6597	0.5
300	EC 300 Endurocross				B10EGV	5927	BR10EIX	6801	0.6
	Enduro 300 (2002 models)	02→	BR8EG	3130			BR8EIX	5044	0.5
	Trial 300		BP5ES	6511			BPR5EIX	6597	0.5
	TXT 300		BPR5ES	7422			BPR5EIX	6597	0.5
321	TX,TXT 321	99→	BP5ES	6511			BPR5EIX	6597	0.5
325	Trial Halley PXC 325		B9ES	2611	B9EVX	7254	BR9EIX	3981	0.5
327	Trial 327		BP5ES	6511			BPR5EIX	6597	0.5
330	Delta 32 GT		BP5ES	6511			BPR5EIX	6597	0.5
400	Pampera 400	06→	CR8E	1275			CR8EIX	4218	0.7
	SM 400FSE-4T	02→	CR8E	1275			CR8EIX	4218	0.7
450	FSE 450	03→	CR8E	1275			CR8EIX	4218	0.7
	SM 450	04→	CR8E	1275			CR8EIX	4218	0.7
500	Normada 500		D8EA	2120	D8EVX	2850	DR8EIX	6681	0.5

GENERIC

50	Trigger SM 50	07→	BR7ES	5122			BR7EIX	6664	0.7
	Trigger X 50	07→	BR7ES	5122			BR7EIX	6664	0.7

GILERA

50	DNA 50 (2-Stroke catalytic)	00→	BR9ES	5722			BR9EIX	3981	0.7
	DNA 50 GP	02→	BR9ES	5722			BR9EIX	3981	0.6
	GSM 50 (Gilera 2-Stroke)	00→	BR9ES	5722			BR9EIX	3981	0.7
	H@K 50 (Gilera 2-Stroke)	00→	BR9ES	5722			BR9EIX	3981	0.7
	ICE 50 (Gilera 2-Stroke)	01→	BR9ES	5722			BR9EIX	3981	0.7
	Jetrunner	03→	CPR8E	7411					0.8
	Pure Jet 50 Direct Injection (2-Stroke)	04→	CPR8E	7411					0.8
	RCR 50 (2-Stroke Derbi engine)	04→	BR9ES	5722			BR9EIX	3981	0.5
	Runner 50 (2-Stroke)	97→	BR9ES	5722			BR9EIX	3981	0.6
	Runner 50 (4-Stroke)	04→	CPR8E	7411					0.8
	SKP 50	97→	BR9ES	5722			BR9EIX	3981	0.5
	SMT 50	05→	BR9ES	5722			BR9EIX	3981	0.6
	Stalker 50	03→	BR9ES	5722			BR9EIX	3981	0.5
	Storm 50	09/07→	BR9ES	5722			BR9EIX	3981	0.6
	125	125T G1,125GR1		B8ES	2411	B8EVX	7051	BR8EIX	5044
Cougar 125		00→03	DPR8EA-9	4929			DPR8EIX-9	2202	0.8
Crono			B10EG	3630	B10EGV	5927	BR10EIX	6801	0.6
CX 125 Apache			B10EG	3630	B10EGV	5927	BR10EIX	6801	0.6
DNA 125 (4-Stroke)		01→	CR9EB	6955			CR9EIX	3521	0.7
Freestyle (2-Stroke)			B10EG	3630	B10EGV	5927	BR10EIX	6801	0.6
GFR125					B10EGV	5927	BR10EIX	6801	0.6
Nexus 125		07→	CR8EB	7784			CR8EIX	4218	0.7
Runner 125 (4-Stroke)			CR9E	6263			CR9EIX	3521	0.6
Runner FX125 (2-Stroke)		97→	BR9ES	5722			BR9EIX	3981	0.6
Runner VX 125 (4-Stroke)		01→	CR9EB	6955			CR9EIX	3521	0.7
RV 125		86→90	B10EG	3630	B10EGV	5927	BR10EIX	6801	0.6
SC125 (2-Stroke)		06→	BR8ES	5422			BR8EIX	5044	0.7
SC125 (4-Stroke) Yamaha engine		07→	BR8ES	5422			BR8EIX	5044	0.7



CC	MODEL	DATE	STANDARD COPPER CORE	STOCK NUMBER	PLATINUM OR GOLD PALLADIUM	STOCK NUMBER	IRIDIUM	STOCK NUMBER	GAP MM
GILERA (CONTINUED)									
180	DNA 180 (4-Stroke)	01→	CR9EB	6955			CR9EIX	3521	0.7
	Runner FXR180 (2-Stroke)	98→	BR9ES	5722			BR9EIX	3981	0.6
	Runner VX 180 (4-Stroke)	01→	CR9EB	6955			CR9EIX	3521	0.7
200	Runner ST 200	08→	CR8EB	7784			CR8EIX	4218	0.6
	Runner VXR 200 (4-Stroke)	02→	CR7EKB	4455			CR7EIX	7385	0.6
250	Nexus 250 SP	06→	CR8EB	7784			CR8EIX	4218	0.6
350	Dakota 350 (4-Stroke)		DPR8EA-9	4929			DPR8EIX-9	2202	0.6
	Saturno 350 (4-Stroke)	90→	DPR8EA-9	4929			DPR8EIX-9	2202	0.6
460	Nexus 500	04→	CR7EKB	4455			CR7EIX	7385	0.6
500	Dakota 500 (4-Stroke)		DPR8EA-9	4929			DPR8EIX-9	2202	0.6
	Fuoco 500	07→	CR7EKB	4455			CR7EIX	7385	0.6
	Saturno 500 (4-Stroke)	90→93	DPR8EA-9	4929			DPR8EIX-9	2202	0.6
560	Nordwest 600 (4-Stroke)	91→95	DPR9EA-9	5329			DPR9EIX-9	5545	0.6
	RC 600 (4-Stroke)		DPR8EA-9	4929			DPR8EIX-9	2202	0.6
600	Supersport 600	02→	CR9E	6263			CR9EIX	3521	0.6
839	GP800	08→	CR7EKB	4455			CR7EIX	7385	0.6

HARLEY DAVIDSON									
883	XL53C, Sportster 883 (All Models)		DCPR7E	3932	DCPR7EVX	1179	DCR7EIX	3605	1.0
1000	XL, XLH, XLCH →1978	→78	B-6L	3212					0.7
	XLCH →1979	→79	B-6L	3212					0.7
	XLH, XLS, XLCH	79→	BP6HS	4511			BPR6HIX	4085	1.0
	XR1000	83→85	BPR6ES-11	4824			BPR6EIX-11	3903	1.0
1100	Sportster 1100	86/87	DCPR7E	3932	DCPR7EVX	1179	DCR7EIX	3605	1.0
1130	VRSC V-Rod, Night Rod, Street Rod	02→	DCPR8E*	4339			DCR8EIX	3606	0.9
1200	FL, FLH, FX, FXE, Super Glide	74	BPR5ES-11	4424			BPR5EIX	6597	1.0
	FLH, FLHR, FX, FXE, FXEF, FXS	75→81	BPR5ES-11	4424			BPR5EIX	6597	1.0
	Sportster 1200 (All Models) 88→	88→	DCPR7E	3932	DCPR7EVX	1179	DCR7EIX	3605	1.0
	XR1200	08→	DCPR9E	2641	DCPR9EVX	6436	DCPR9EIX	2316	0.9
1250	VRSC Screamin' Eagle V-Rod	04→	DCPR9E	2641	DCPR9EVX	6436	DCPR9EIX	2316	0.6
1340	All Evolution Engines 1984→	84→98	BPR5ES-11	4424			BPR5EIX	6597	1.0
	All Shovel Head Engines 1982→1984	82→84	ZGR5C	6334					1.0
1450	All 1450cc Models 1999→	99→	DCPR7E	3932	DCPR7EVX	1179	DCR7EIX	3605	1.0
1584	Twin Cam 96B Models	06/06→	DCPR8E*	4339			DCR8EIX	3606	0.9

HERO-PUCH									
50	Blinker, Stark, Turbo Sport	94→	BP5ES	6511			BPR5EIX	6597	0.5

HESKETH									
1000	V1000	82→	DR8ES	5423	DR9EVX	6361	DR9EIX	4772	0.7

HONDA									
50	C50		C7HSA	4629			CR7HIX	7544	0.7
	C50C		CR7HS	7223			CR7HIX	7544	0.7
	C50-E SUPER CLUB	84→85	CR7HS	7223			CR7HIX	7544	0.7
	C50L, C50LA-C, C50LA-E	82→88	CR7HS	7223			CR7HIX	7544	0.7
	C50ZZ, C50ZZ		CR7HS	7223			CR7HIX	7544	0.7
	CB50J		CR6HS	7023			CR6HIX	7274	0.7
	CR50R-E/F/G		BR9ES	5722			BR9EIX	3981	0.7
	CRF50F	04→	CR6HSA	2983			CR6HIX	7274	0.6
	MB50A-B		BR7HS	4122			BR7HIX	7067	0.7
	MBX50S-D	83→86	BR6ES	4922					0.7
	Melody, Mini Melody, Vision		BPR6HSA	4632			BPR6HIX	4085	0.7
	MT50A-B, MT50S-L	80→93	BR7HS	4122			BR7HIX	7067	0.7
	MTX50S-C	82→85	BR7HS	4122			BR7HIX	7067	0.7
	NC50		BPR6HSA	4632			BPR6HIX	4085	0.7
	ND50M-C		BPR4HS	7823					0.7



* Please note DCPR8E 4339 has a removable terminal nut, whereas DCPR8E 4179 has a fixed terminal nut



2 Wheel



CC	MODEL	DATE	STANDARD COPPER CORE	STOCK NUMBER	PLATINUM OR GOLD PALLADIUM	STOCK NUMBER	IRIDIUM	STOCK NUMBER	GAP MM
HONDA (CONTINUED)									
50	NE50	85→90	BPR6HSA	4632			BPR6HIX	4085	0.7
	NS50MS	81→85	BPR6HSA	4632			BPR6HIX	4085	0.7
	NT50-H	87→94	BPR6HSA	4632			BPR6HIX	4085	0.7
	NU50M-C		BPR5HS	6222					0.7
	NV50MS-D	82→87	BPR5HS	6222					0.7
	NX50M		BPR5HS	6222					0.7
	PA50VC	86→91	BPR6HS	7022			BPR6HIX	4085	0.7
	PF50MR2		B6HS	4510			BR6HIX	3419	0.7
	PX50	81→86	BPR5HS	6222					0.7
	PXR50	85→87	BPR4HS	7823					0.7
	QR50-D, QR50-F/R		BPR4HS	7823					0.7
	SA50-J, SA50M/N/P	88→95	BPR6HSA	4632			BPR6HIX	4085	0.7
	SFX50S-T-V-W-X-Y	95→03	BR6HSA	4296			BPR6HIX	4085	0.6
	SGX50-V-W-X-Y (SKY)	97→	BR6HSA	4296			BPR6HIX	4085	0.6
	SH50E-S	84→96	BPR6HS	7022			BPR6HIX	4085	0.7
	SH50T-X-Y Bali	96→03	BR6HSA	4296			BPR6HIX	4085	0.6
	SJ50-P-R-S-V-W	93→99	BR6HSA	4296			BPR6HIX	4085	0.6
	SRX50 Shadow	2003	BR6HSA	4296			BPR6HIX	4085	0.6
	ST50J DAX, ST50J/K	88→93	CR6HSA	2983			CR6HIX	7274	0.7
	SZX-50 (X8R-S, X8R-X)		BR6HSA	4296			BPR6HIX	4085	0.6
	TLM50		B8ES	2411	B8EVX	7051	BR8EIX	5044	0.7
	X8R S/X	98→03	BR6HSA	4296			BPR6HIX	4085	0.6
	XR50	96→02	CR6HSA	2983			CR6HIX	7274	0.7
	XR50R	03→	CR6HSA	2983			CR6HIX	7274	0.7
	XR50 Motard	05→	CR6HSA	2983			CR6HIX	7274	0.9
	Z50R-D		CR6HS	7023			CR6HIX	7274	0.7
	Zoomer	06→	ER8EH-N	5606					0.7
60	CR60R-G		BR9ES	5722			BR9EIX	3981	0.7
70	C70C/E	82→86	CR7HS	7223			CR7HIX	7544	0.7
	CRF70F	04→	CR6HSA	2983			CR6HIX	7274	0.6
	CZ70ZZ, CZ70Z2, C70/C, CF70/C		CR7HS	7223			CR7HIX	7544	0.7
	XR70V, XR70R		CR6HSA	2983			CR6HIX	7274	0.6
80	CR80R-D/E/F/2F/G/2G		BR9ES	5722			BR9EIX	3981	0.7
	CR80R, CR80R2	02→	BR10EG	3830			BR10EIX	6801	0.5
	CR80RB		B9EG	3530	B9EGV	5827	BR9EIX	3981	0.7
	CR80RH-RS/T/V		BR10EG	3830			BR10EIX	6801	0.5
	MBX80FWD-D	83→86	BR9ES	5722			BR9EIX	3981	0.7
	MTX80R-E	83→86	BR8ES	5422			BR8EIX	5044	0.7
	NH80MD/H-P	82→96	BPR6HS	7022			BPR6HIX	4085	0.7
	XR80R-J		CR7HS	7223			CR7HIX	7544	0.7
85	CR85R/R2	03→06	BR10EG	3830			BR10EIX	6801	0.5
90	C90 ZZ (Step Thru)	79→83	D6HA	6512					0.7
	C90E-C/E/G, C90MF-T (Step Thru)	84→96	CR7HS	7223			CR7HIX	7544	0.7
	C90MT (Step Thru)	96→03	CR6HSA	2983			CR6HIX	7274	0.6
	CM90, CM91		D6HA	6512					0.7
	EZ90-M		BR7HS	4122			BR7HIX	7067	0.7
	S90		D6HA	6512					0.7
	SXR90 Joker	01→	BR6HSA	4296			BPR6HIX	4085	0.6
100	CB100 (N/NA/NB)	78→86	DR8ES-L	2923	DR8EVX	6354	DR8EIX	6681	0.7
	CRF100F	04→	CR7HSA	4549			CR7HIX	7544	0.6
	H100A/B/S2G	80→92	BR7HS	4122			BR7HIX	7067	0.7
	H100SE/J		BR8HS	4322			BR8HIX	7001	0.7
	SCV100 Lead	03→	CR6HSA	2983			CR6HIX	7274	0.6
	SJ100T-V-W (Bali)	97→99	BR6HSA	4296			BPR6HIX	4085	0.6
	XR100 Motard	05→	CR7HSA	4549			CR7HIX	7544	0.9
	XR100R		CR7HSA	4549			CR7HIX	7544	0.6
	108	Lead (Fi)	08→	CR8EH-9	5666			CR8EHIX-9	3797
125	ANF125 Innova	03→	CPR6EA-9	6899					0.9
	ANF125i Innova	07→	CPR6EA-9	6899					0.9
	CA125S	95→99	CR6HSA	2983			CR6HIX	7274	0.6
	CB125 (S/S1/J)		D8EA	2120	D8EVX	2850	DR8EIX	6681	0.7
	CB125RS-D/E	83→86	DR8ES-L	2923	DR8EVX	6354	DR8EIX	6681	0.7
	CB125T (2/B/D-C/D/D-E)	82→88	CR8HS	7423	CR8HVX	7236	CR8HIX	7669	0.7
	CBF125	08→	CPR7EA-9	3901					0.9
CBR125R	04→	CR8E	1275			CR8EIX	4218	0.7	



CC	MODEL	DATE	STANDARD COPPER CORE	STOCK NUMBER	PLATINUM OR GOLD PALLADIUM	STOCK NUMBER	IRIDIUM	STOCK NUMBER	GAP MM
HONDA (CONTINUED)									
125	CC125		D8EA	2120	D8EVX	2850	DR8EIX	6681	0.7
	CG125 C→T	76→96	DR8ES-L	2923	DR8EVX	6354	DR8EIX	6681	0.7
	CG125 W→	97→	DPR8EA-9	4929			DPR8EIX-9	2202	0.9
	CH125-D/E	83→87	DPR7EA-9	5129	DPR7EVX-9	7682	DPR7EIX-9	7803	0.9
	CLR125 City Fly	98→03	DPR8EA-9	4929			DPR8EIX-9	2202	0.8
	CM125/RB		B9EG	3530	B9EGV	5827	BR9EIX	3981	0.5
	CM125C-C	82→86	CR7HS	7223			CR7HIX	7544	0.7
	CR125R D-S/T/V		BR9EG	3230			BR9EIX	3981	0.5
	CT125C	82→85	DR8ES-L	2923	DR8EVX	6354	DR8EIX	6681	0.7
	FES 125 Pantheon (2-Stroke)	98→02	BR8ES	5422			BR8EIX	5044	0.6
	FES 125 Pantheon (4-Stroke)	03→	CR8EH-9	5666			CR8EHIX-9	3797	0.9
	MBX125FE/RW-F/H/L		BR8ES	5422			BR8EIX	5044	0.7
	MTX125R-D/E/F	83→94	BR8ES	5422			BR8EIX	5044	0.7
	NES125 @	00→03	CR8EH-9	5666			CR8EHIX-9	3797	0.9
	NH125MD-D	83→87	BPR6HS	7022			BPR6HIX	4085	0.7
	NS125 F R/S		BR9ECS	3570					0.7
	NS125FG/FH/RK-RP	86→93	BR7ES	5122			BR7EIX	6664	0.7
	NSR125R-R-S-V	90→03	BR9ECS	3570					0.7
	PS125i (PES125i)	07→	CR8EH-9	5666			CR8EHIX-9	3797	0.9
	SES125 Dylan	02→	CR8EH-9	5666			CR8EHIX-9	3797	0.9
	SH125	01→	CR8EH-9	5666			CR8EHIX-9	3797	0.9
	SH125i	09→	CR8EH-9	5666			CR8EHIX-9	3797	0.9
	S-Wing 125	07→	CR8EH-9	5666			CR8EHIX-9	3797	0.9
	VT125 /C2 Shadow	98→	CR8EH-9	5666			CR8EHIX-9	3797	0.8
	XL125	07→	D8EA	2120	D8EVX	2850	DR8EIX	6681	0.7
	XL125 (S/SA/SB/RO/RF)	75→87	DR8ES-L	2923	DR8EVX	6354	DR8EIX	6681	0.7
	XL125V Varadero	01→	CR8EH-9	5666			CR8EHIX-9	3797	0.9
XLR125R	97→99	DPR8EA-9	4929			DPR8EIX-9	2202	0.8	
XR125L	03→	DPR8EA-9	4929			DPR8EIX-9	2202	0.8	
150	CRF150R/R2	07→	CR8EH-9	5666			CR8EHIX-9	3797	0.9
	CRF150R/B	09→	CR8EH-9	5666			CR8EHIX-9	3797	0.9
185	CD185T		CR7HS	7223			CR7HIX	7544	0.7
	XL185S (2/A/B)		DR8ES-L	2923	DR8EVX	6354	DR8EIX	6681	0.7
200	CB200		D8EA	2120	D8EVX	2850	DR8EIX	6681	0.7
	CD200T (A/B), CM200T (A/B)	80→85	CR7HS	7223			CR7HIX	7544	0.7
	MTX200RW-D	83→86	BR9ES	5722			BR9EIX	3981	0.7
	TLR200R-E/F		DR8ES-L	2923	DR8EVX	6354	DR8EIX	6681	0.7
	XR200 (A/R-C)		DR8ES-L	2923	DR8EVX	6354	DR8EIX	6681	0.7
230	CRF230F	08→	DPR8EA-9	4929			DPR8EIX-9	2202	0.8
250	CB250 K2,K3,K4,G5		B8ES	2411	B8EVX	7051	BR8EIX	5044	0.7
	CB250N A/B/DXB	78→83	DR8ES	5423	DR9EVX	6361	DR9EIX	4772	0.7
	CB250N/T/W	92→	CR6HSA	2983			CR6HIX	7274	0.7
	CB250RS (A/B)	80→83	DR8ES-L	2923	DR8EVX	6354	DR8EIX	6681	0.7
	CB250RSD-C	82→84	DR8ES	5423	DR9EVX	6361	DR9EIX	4772	0.7
	CB250T		DR8ES-L	2923	DR8EVX	6354	DR8EIX	6681	0.7
	CBF250	04→	CR8EH-9S	7750			CR8EHIX-9	3797	0.9
	CBX250RSE	84→86	DPR8EA-9	4929			DPR8EIX-9	2202	0.9
	CD250U-J/K	88→93	CR6HSA	2983			CR6HIX	7274	0.7
	CH250F/G (Spacy)	85→87	DPR6EA-9	5531					0.9
	CL250S-C	82→84	DR8ES-L	2923	DR8EVX	6354	DR8EIX	6681	0.7
	CM250T	82→84	DR8ES	5423	DR9EVX	6361	DR9EIX	4772	0.7
	CMX250C-T	95→99	CR6HSA	2983			CR6HIX	7274	0.6
	CN250-L/M/N	90→92	DPR6EA-9	5531					0.9
	CR250 R3/R-D/E/F/G/H		BR8EG	3130			BR8EIX	5044	0.5
	CR250R-J		BR9EG	3230			BR9EIX	3981	0.5
	CR250R-S/T/V		BR8EG	3130			BR8EIX	5044	0.5
	CR250R K5	05→	BR9EG-N-8	2689					0.8
	CRF250R K5/K6 (19mm Thread Reach)	04→09					R0409B-8	7791	0.7
	CRF250R (26.5mm Thread Reach)	10→					R0451B-8	9356	0.7
	CRF250X K5/K6	04→					IMR8C-9H	3653	0.9
	FES250 W-X-Y (Foresight)	97→03	DPR7EA-9	5129	DPR7EVX-9	7682	DPR7EIX-9	7803	0.9
	RTL250		D6EA	7512					0.7
	TL250		D7EA	7912					0.7
	TLR250F		DR8ES-L	2923	DR8EVX	6354	DR8EIX	6681	0.7
	VT250F-D	83→87	DPR8EA-9	4929			DPR8EIX-9	2202	0.9

2 Wheel



CC	MODEL	DATE	STANDARD COPPER CORE	STOCK NUMBER	PLATINUM OR GOLD PALLADIUM	STOCK NUMBER	IRIDIUM	STOCK NUMBER	GAP MM
HONDA (CONTINUED)									
250	XL250/K3		D8EA	2120	D8EVX	2850	DR8EIX	6681	0.7
	XL250R-C	82→84	DR8ES-L	2923	DR8EVX	6354	DR8EIX	6681	0.7
	XL250RE	84→86	DPR9Z	4830					0.7
	XL250S (A/B/Z)	73→82	DR8ES-L	2923	DR8EVX	6354	DR8EIX	6681	0.7
	XR250	→84	D8EA	2120	D8EVX	2850	DR8EIX	6681	0.7
	XR250RE	84→95	DPR9Z	4830					0.7
	XR250RT/V	96→01	CR9EH-9	7502			CR9EHIX-9	6216	0.9
280	SH300i	07→	LMAR8A-9	4313					0.9
350	CB350SG	86→88	DR8ES-L	2923	DR8EVX	6354	DR8EIX	6681	0.7
	XR350R-D		DPR8EA-9	4929			DPR8EIX-9	2202	0.9
	XR350R-E		DPR7EA-9	5129	DPR7EVX-9	7682	DPR7EIX-9	7803	0.9
360	CB360G		B8ES	2411	B8EVX	7051	BR8EIX	5044	0.7
400	CB400 (N/NA/NC/T)	78→85	DR8ES	5423	DR9EVX	6361	DR9EIX	4772	0.7
	CB400F1, F2		D8EA	2120	D8EVX	2850	DR8EIX	6681	0.7
	NS400RF	85→88	BR9ES	5722			BR9EIX	3981	0.7
	VF400F-D	83→86	DPR8EA-9	4929			DPR8EIX-9	2202	0.9
	VFR400 R3-L-P	90→93	ER9EH	5869					0.7
	XR400RT/V		DPR8Z	4730					0.6
450	CB450DX-K	89→92	DR8ES	5423	DR9EVX	6361	DR9EIX	4772	0.7
	CRF450R (19mm Thread Reach)	02→08					IFR8H11	5068	1.1
	CRF450R (26.5mm Thread Reach)	09→					SILMAR9A9S	6213	0.9
	CRF450X	08→					IFR8H11	5068	1.1
480	CR480R-D		B8EG	3430	B8EGV	5627	BR8EIX	5044	0.5
500	CB500 T	→80	B8ES	2411	B8EVX	7051	BR8EIX	5044	0.7
	CB500-R/T/V/W/X/Y	94→	CR8EH-9	5666			CR8EHIX-9	3797	0.9
	CB500S-W (Half Fairing)	98→	CR8EH-9	5666			CR8EHIX-9	3797	0.9
	CBF500	04→	CR8EH-9S	7750			CR8EHIX-9	3797	0.9
	CR500R-E-S/T/V/W/X	93→	BR8EG	3130			BR8EIX	5044	0.5
	CX500 (Z/A/B/CA/DA/CB/EC)	78→84	DR8ES-L	2923	DR8EVX	6354	DR8EIX	6681	0.7
	CX500 TURBO	82→84					DPR8EIX-9	2202	0.9
	FT500-C	82→84	DR8ES	5423	DR9EVX	6361	DR9EIX	4772	0.7
	GL500 Silverwing	82→84	DR8ES-L	2923	DR8EVX	6354	DR8EIX	6681	0.6
	VF500F 2E/2F	84→87	DPR8EA-9	4929			DPR8EIX-9	2202	0.9
	VT500E-D/F	83→88	DPR8EA-9	4929			DPR8EIX-9	2202	0.9
	XBR500F/H/SJ	85→89	DPR8EA-9	4929			DPR8EIX-9	2202	0.9
	XL500 (SA,RC)	79→84	DR8ES-L	2923	DR8EVX	6354	DR8EIX	6681	0.7
	XR500		DR8ES-L	2923	DR8EVX	6354	DR8EIX	6681	0.7
	550	CB550		DR7ES	3123				
CBX550F (C,2-C)		82→86	DR8ES	5423	DR9EVX	6361	DR9EIX	4772	0.7
600	CB600F (Hornet)	98→06	CR9EH-9	7502			CR9EHIX-9	6216	0.9
	CB600F (Hornet)	07→	CR9EH-9	7502			CR9EHIX-9	6216	0.9
	CB600FA (Hornet with ABS)	08→	CR9EH-9	7502			CR9EHIX-9	6216	0.9
	CBF600 N/S (Including ABS)	04→07	CR9EH-9	7502			CR9EHIX-9	6216	0.9
	CBF600 N/S (Including ABS)	08→	CR8EH-9	5666			CR8EHIX-9	3797	0.9
	CBR600F-H-J	87→88	DPR8EA-9	4929			DPR8EIX-9	2202	0.9
	CBR600F-K-L	89→90	DPR9EA-9	5329			DPR9EIX-9	5545	0.9
	CBR600F-M-N-P-R-S-T-V-W	91→98	CR9EH-9	7502			CR9EHIX-9	6216	0.9
	CBR600F X-Y	99→00	CR9EH-9	7502			CR9EHIX-9	6216	0.9
	CBR600FI / FSI Injection	01→					IMR9A-9H	6966	0.9
	CBR600F Injection	02→					IMR9C-9H	6777	0.9
	CBR600F Sport	02→					IMR9C-9H	6777	0.9
	CBR600RR	03/03→08					IMR9C-9HES	5766	0.9
	CBR600RR /ABS	09→					IMR9E-9HES	7556	0.9
	FJS600 Silverwing (Including ABS)	01→	CR8EH-9	5666			CR8EHIX-9	3797	0.9
	NTV600K/M Reverse	88→93	DPR8EA-9	4929			DPR8EIX-9	2202	0.9
	VT600C-N-P-R-S-T-V-W	92→01	DPR8EA-9	4929			DPR8EIX-9	2202	0.9
	XL600LM-F	84→86	DPR8EA-9	4929			DPR8EIX-9	2202	0.9
	XL600RD-E	84→86	DPR8EA-9	4929			DPR8EIX-9	2202	0.9
	XL600VH-VX (Transalp)	87→00	DPR8EA-9	4929			DPR8EIX-9	2202	0.9
	XR600R-V		DPR8EA-9	4929			DPR8EIX-9	2202	0.8
650	CB650 Z, 2, B	78→82	DR8ES-L	2923	DR8EVX	6354	DR8EIX	6681	0.7
	CB650 SC-C (Nighthawk)	82→84	DR8ES-L	2923	DR8EVX	6354	DR8EIX	6681	0.7
	CX650E-D	83→86	DPR8EA-9	4929			DPR8EIX-9	2202	0.9
	CX650TC-D	83→85	DPR8EA-9	4929			DPR8EIX-9	2202	0.9
	FMX650	05→08	DPR8EA-9	4929			DPR8EIX-9	2202	0.9



CC	MODEL	DATE	STANDARD COPPER CORE	STOCK NUMBER	PLATINUM OR GOLD PALLADIUM	STOCK NUMBER	IRIDIUM	STOCK NUMBER	GAP MM
HONDA (CONTINUED)									
650	FX650 Vigor	99→03	DPR8EA-9	4929			DPR8EIX-9	2202	0.9
	NT650V-W-X-Y (Deauville)	98→05	DPR8EA-9	4929			DPR8EIX-9	2202	0.9
	NTV650P-T/V	92→97	DPR8EA-9	4929			DPR8EIX-9	2202	0.9
	NX650K-T-V-W-X Dominator	88→03	DPR8EA-9	4929			DPR8EIX-9	2202	0.9
	SLR650	96→99	DPR8EA-9	4929			DPR8EIX-9	2202	0.8
	XL650 /-V (Transalp)	00→07	DPR8EA-9	4929			DPR8EIX-9	2202	0.9
	XR650R, R-2		BKR7E-11	1283					1.0
680	NT700V Deauville (Including ABS)	06→	CPR8EA-9	2306					0.9
	XL700V Transalp (Including ABS)	08→	CPR8EA-9	2306					0.9
750	CB750		DR8ES	5423	DR9EVX	6361	DR9EIX	4772	0.7
	CB750F-2		D8EA	2120	D8EVX	2850	DR8EIX	6681	0.7
	CB750F-A/F-B/F2-B/F-C/F2-C/FD	80→84	DR8ES	5423	DR9EVX	6361	DR9EIX	4772	0.7
	CB750F2-N/P/R/S/T/V/W/X	92→02	DPR8EA-9	4929			DPR8EIX-9	2202	0.9
	CB750K-1/K-2/K-3/K-4/K-6/K-Z/F-1		DR8ES-L	2923	DR8EVX	6354	DR8EIX	6681	0.7
	CB750K-7		D8EA	2120	D8EVX	2850	DR8EIX	6681	0.7
	CBX750FE	84→86	DPR8EA-9	4929			DPR8EIX-9	2202	0.9
	RVF750R-S (RC45)	94→98					CR9EHIX-9	6216	0.9
	VF750 (C/F/S)		DPR8EA-9	4929			DPR8EIX-9	2202	0.9
	VF750CP-S		CR8EH-9	5666			CR8EHIX-9	3797	0.9
	VFR750F G-F-K	86→88	DPR9EA-9	5329			DPR9EIX-9	5545	0.9
	VFR750F L-T-V	89→97	CR8EH-9	5666			CR8EHIX-9	3797	0.9
	VFR750R-K/L (RC30)	88→92	CR9EH-9	7502			CR9EHIX-9	6216	0.9
	VT750C2 VT750 V/W Shadow	97→	DPR8EA-9	4929			DPR8EIX-9	2202	0.8
	VT750DC Shadow	01→	DPR8EA-9	4929			DPR8EIX-9	2202	0.8
	VT750C NEC Shadow Spirit	07→	DPR7EA-9	5129	DPR7EVX-9	7682	DPR7EIX-9	7803	0.9
	VT750DC Shadow Spirit	07→	DPR7EA-9	5129	DPR7EVX-9	7682	DPR7EIX-9	7803	0.9
XRV750L-V-W-X-Y (Africa Twin)	90→03	DPR8EA-9	4929			DPR8EIX-9	2202	0.9	
800	VFR800F-W (With 781cc engine) Fi-X-Y	97→	CR9EH-9	7502			CR9EHIX-9	6216	0.8
	VFR800F-W →K6 FIVTEC (Including ABS)	02→					IMR9B-9H	4888	0.9
900	CB900F/F2 (Z, D, 2-D)	79→85	DR8ES	5423	DR9EVX	6361	DR9EIX	4772	0.7
	CB900F Hornet	02→08	CR8EH-9	5666			CR8EHIX-9	3797	0.9
	CBR900RR-N-S Fireblade (893cc)	92→95	CR9EH-9	7502			CR9EHIX-9	6216	0.9
	CBR900RR-T-V-W-X Fireblade (918cc)	96→99	CR9EH-9	7502			CR9EHIX-9	6216	0.9
	CBR900RR Y Fireblade (929cc Injection Model)	00→01					CR9EHI-9	6419	0.9
	CBR900RR K2 Fireblade (954cc '02 model)	02→03					IMR9C-9H	6777	0.9
1000	CB1000F-V		DPR9EA-9	5329			DPR9EIX-9	5545	0.9
	CB1000R/RA	08→					IMR9E-9HES	7556	0.9
	CBF1000 (Including ABS)	06→	CR8EH-9	5666			CR8EHIX-9	3797	0.9
	CBR1000FH-FX	87→99	DPR9EA-9	5329			DPR9EIX-9	5545	0.9
	CBR1000RR Fireblade	04→07					IMR9C-9HES	5766	0.9
	CBR1000RR Fireblade (Including ABS)	08→					IMR9E-9HES	7556	0.9
	GL1000 (Gold Wing)	75→	DR8ES-L	2923	DR8EVX	6354	DR8EIX	6681	0.7
	VF1000F2F Bol d'Or		DPR9EA-9	5329			DPR9EIX-9	5545	0.9
	VF1000FE	84→85	DPR8EA-9	4929			DPR8EIX-9	2202	0.9
	VF1000FF	85→87	DPR9EA-9	5329			DPR9EIX-9	5545	0.9
	VF1000RE-High Speed		DPR9EA-9	5329			DPR9EIX-9	5545	0.9
	VF1000RE-Standard		DPR8EA-9	4929			DPR8EIX-9	2202	0.9
	VF1000RF	85→88	DPR9EA-9	5329			DPR9EIX-9	5545	0.9
	VTR1000 F-W-X-Y (Firestorm)	97→08					DPR9EIX-9	5545	0.9
	VTR1000 SP1	00→01					FR9BI-11	4709	1.1
	VTR1000 SP2	02→					IFR9H11	6588	1.1
XL1000V-Y (Varadero)	98→02					DPR8EIX-9	2202	0.8	
XL1000V Varadero (Including ABS)	03→					IJR8B9	4873	0.9	
1050	CBX1000B,C (6 Cyl)	78→84	DR8ES-L	2923	DR8EVX	6354	DR8EIX	6681	0.7
1100	CB1100 (RB,RC,RD) Road Use	82→84	DR8ES	5423	DR9EVX	6361	DR9EIX	4772	0.7
	CB1100SF-Y (X11)	99→					CR8EHIX-9	3797	0.9
	CBR1100 XX-V-W-X-Y (Super Blackbird)	96→					CR9EHIX-9	6216	0.9
	CBR1100 XX-K1 (Super Blackbird)	2001					IMR9A-9H	6966	0.9
	CBR1100 XX K2 (Super Blackbird) 3405930→	02→					IMR9C-9H	6777	0.9
	GL1100B (Gold Wing)	80→	DR8ES-L	2923	DR8EVX	6354	DR8EIX	6681	0.7
	ST1100 ABS/TCS/T/V		CR8EH-9	5666			CR8EHIX-9	3797	0.9
	ST1100/L-S/T/V/W/X/Y (Pan European)	89→03	CR8EH-9	5666			CR8EHIX-9	3797	0.9
1200	GL1200-EDE/IE/AE/AF/AH (Gold Wing)	84→88	DPR7EA-9	5129	DPR7EVX-9	7682	DPR7EIX-9	7803	0.9
1260	ST1300 Pan European (Including ABS)	02→	CR7EH-9	3486					0.9

2 Wheel



CC	MODEL	DATE	STANDARD COPPER CORE	STOCK NUMBER	PLATINUM OR GOLD PALLADIUM	STOCK NUMBER	IRIDIUM	STOCK NUMBER	GAP MM
HONDA (CONTINUED)									
1300	CB1300 (Including ABS)	03→	DPR8EA-9	4929			DPR8EIX-9	2202	0.9
	CB1300S (Including ABS)	05→	DPR8EA-9	4929			DPR8EIX-9	2202	0.9
	VTX1300	03→	DCPR6E	3481					0.9
1500	GL1500-J/K/L, GL1500 SE/M/N/P/R/S/T/V/W/X/Y (Gold Wing)	88→01	DPR6EA-9	5531					0.9
	GL1500CT (Gold Wing)	97→00	DPR7EA-9	5129	DPR7EVX-9	7682	DPR7EIX-9	7803	0.9
	GL1500C-V-W-(F6C) (Gold Wing)	96→03	DPR7EA-9	5129	DPR7EVX-9	7682	DPR7EIX-9	7803	0.9
1800	GL1800 (Gold Wing) (Including ABS)	01→	BKR6E-11	2756			BKR6EIX-11	3764	1.1
	VTX1800/C	01→08					IFR6L11	3678	1.1

HUSABERG									
400	FE,FS 400E/C	00→	DCPR8E*	4179			DCR8EIX	3606	0.6
450	FE 450	09→					LKAR8AI-9	6706	0.9
470	FC, FX 470/6, E	00→	DCPR8E*	4179			DCR8EIX	3606	0.6
550	FC 550/4/6	00→	DCPR8E*	4179			DCR8EIX	3606	0.6
565	FE 570	09→					LKAR8AI-9	6706	0.9
650	FE, FS, FX 650 Supermoto	00→	DCPR8E*	4179			DCR8EIX	3606	0.6

HUSQVARNA									
50	Husky Boy Basic	00→04	B8HS	5510	B8HVX	2634	BR8HIX	7001	0.5
	Husky Boy Junior	99→02	B6HS	4510			BR6HIX	3419	0.5
	Husky Boy Junior	03→			B10EGV	5927	BR10EIX	6801	0.6
	Husky Boy Racing	01→	B6HS	4510			BR6HIX	3419	0.5
	Husky Boy Senior	99→02	B6HS	4510			BR6HIX	3419	0.5
	Husky Boy Senior	03→			B10EGV	5927	BR10EIX	6801	0.6
	SM50	02→	BR9ES	5722			BR9EIX	3981	0.7
	WRS 50 (Scooter)		B9ES	2611	B9EVX	7254	BR9EIX	3981	0.7
	WSM 50	03→	BR9ES	5722			BR9EIX	3981	0.7
	WXE 50	03→	BR9ES	5722			BR9EIX	3981	0.7
125	CR125	→91	B9EG	3530	B9EGV	5827	BR9EIX	3981	0.5
	CR125	92→01			B95EGV	2145			0.5
	CR125	02→05	BR9EG	3230			BR9EIX	3981	0.5
	SM125 /S	98→	BR9EG	3230			BR9EIX	3981	0.5
	WR125	→91	B9EG	3530	B9EGV	5827	BR9EIX	3981	0.5
	WR125	92→			B95EGV	2145			0.5
	WR125	02→	BR9EG	3230			BR9EIX	3981	0.5
	WRE125	94→97	B10EG	3630	B10EGV	5927	BR10EIX	6801	0.5
	WRE125	98→	BR9EG	3230			BR9EIX	3981	0.5
	WRK125	→89			B10EGV	5927	BR10EIX	6801	0.5
	WSM125	04→	CR7HSA	4549			CR7HIX	7544	0.7
	WXE125	04→	CR7HSA	4549			CR7HIX	7544	0.7
	240	WR240		B8EG	3430	B8EGV	5627	BR8EIX	5044
250	CR250	92→00			B95EGV	2145			0.5
	CR250	01→04	B8EG	3430	B8EGV	5627	BR8EIX	5044	0.5
	CR250	04→	BR8EG	3130			BR8EIX	5044	0.6
	TC250	02→05	CR8EB	7784			CR8EIX	4218	0.7
	TE250	02→	CR8EB	7784			CR8EIX	4218	0.7
	WR250	92→01			B9EGV	5827	BR9EIX	3981	0.5
	WR250	02→	BR8EG	3130			BR8EIX	5044	0.6
	WRK250→1989	→89			B10EGV	5927	BR10EIX	6801	0.5
260	WRK260→1989	→89			B10EGV	5927	BR10EIX	6801	0.5
300	WR300	09→	BR8EG	3130			BR8EIX	5044	0.6
310	TE310	09→	CR8EB	7784			CR8EIX	4218	0.7
350	TE350	90→95	C8E	7471			CR8EIX	4218	0.5
	WR350 1992→	92→02			B9EGV	5827	BR9EIX	3981	0.5
360	CR360	92→94			B8EGV	5627	BR8EIX	5044	0.5
	WR360	02→	B8EG	3430	B8EGV	5627	BR8EIX	5044	0.5
390	CR390		B8EG	3430	B8EGV	5627	BR8EIX	5044	0.5
400	SM400	02→05	CR8EB	7784			CR8EIX	4218	0.7
	TE400	01→	CR8EB	7784			CR8EIX	4218	0.7
	WR400		B8EG	3430	B8EGV	5627	BR8EIX	5044	0.5
410	TE410	96→00	C8E	7471			CR8EIX	4218	0.5



* Please note DCPR8E 4339 has a removable terminal nut, whereas DCPR8E 4179 has a fixed terminal nut





CC	MODEL	DATE	STANDARD COPPER CORE	STOCK NUMBER	PLATINUM OR GOLD PALLADIUM	STOCK NUMBER	IRIDIUM	STOCK NUMBER	GAP MM
HUSQVARNA (CONTINUED)									
410	TE410e	99→00	CR7E	4578			CR7EIX	7385	0.6
430	CR430		B8EG	3430	B8EGV	5627	BR8EIX	5044	0.5
	WR430		B8EG	3430	B8EGV	5627	BR8EIX	5044	0.5
435	CR435		B8EG	3430	B8EGV	5627	BR8EIX	5044	0.5
450	SM450R	03→	CR8EB	7784			CR8EIX	4218	0.7
	TC450	04→	CR8EB	7784			CR8EIX	4218	0.7
	TE450	03→	CR8EB	7784			CR8EIX	4218	0.7
500	CR500		B8EG	3430	B8EGV	5627	BR8EIX	5044	0.5
	WR500		B8EG	3430	B8EGV	5627	BR8EIX	5044	0.5
	TC500 (Air Cooled) →5/1986	→5/86	D8EA	2120	D8EVX	2850	DR8EIX	6681	0.5
510	TC510 (Water Cooled) 6/1986→	06/86→90	C7E	5096			CR7EIX	7385	0.5
	TE510 (Air Cooled) →5/1986	→5/86	D8EA	2120	D8EVX	2850	DR8EIX	6681	0.5
	TE510 (Water Cooled) 6/1986→	06/86→90	C7E	5096			CR7EIX	7385	0.6
	TE510	04→	CR8EB	7784			CR8EIX	4218	0.7
570	SM570	01→04	CR7EB	4663			CR7EIX	7385	0.6
	SM570R	02→04	C7E	5096			CR7EIX	7385	0.6
	SM570R 2004 (Competition Plug)	04→	C8E	7471			CR8EIX	4218	0.5
	TC570	01→02	CR7EB	4663			CR7EIX	7385	0.6
	TE570	01→03	CR7EB	4663			CR7EIX	7385	0.6
610	SM610 S (Std. Plug)	98→05	CR7E	4578			CR7EIX	7385	0.6
	SM610 S (Competition Plug)	03→	C8E	7471			CR8EIX	4218	0.5
	SM610	06→	CPR8E	7411					0.8
	TC610 1991→	91→00	C7E	5096			CR7EIX	7385	0.5
	TE610 1991→	91→00	C8E	7471			CR8EIX	4218	0.5
	TE610e	98→05	CR7E	4578			CR7EIX	7385	0.6
630	SMR630	04→	R0045J-10	7400					1.1

HYOSUNG									
50	SD50, Sense50	99→05	BP6HS	4511			BPR6HIX	4085	0.7
	SF50	99→05	BR8HSA	5539			BPR8HIX	6742	0.7
100	EZ100	99→	BP7HS	5111			BPR7HIX	5944	0.7
110	FX110		C6HSA	3228			CR6HIX	7274	0.7
	Midas DLX 110	99→	C6HSA	3228			CR6HIX	7274	0.7
125	Cruise 1 125	96→	D8EA	2120	D8EVX	2850	DR8EIX	6681	0.7
	Cruise 2 125	99→	CR8EH-9	5666			CR8EHIX-9	3797	0.9
	GA125 Cruise III	00→	CR8EH-9	5666			CR8EHIX-9	3797	0.9
	GF125	99→	CR8EH-9	5666			CR8EHIX-9	3797	0.9
	Grand Prix 125, GP-Plus	99→	DR8EA	7162	DR8EVX	6354	DR8EIX	6681	0.7
	GT125	03→	CR8E	1275			CR8EIX	4218	0.6
	GT125R	06→	CR8E	1275			CR8EIX	4218	0.6
	GV125 Aquila	00→	CR8E	1275			CR8EIX	4218	0.6
	GV125C	08→	CR8E	1275			CR8EIX	4218	0.8
	HD125 Hyper	04→06	DR8EA	7162	DR8EVX	6354	DR8EIX	6681	0.8
	MS3-125	07→	CR8E	1275			CR8EIX	4218	0.8
	RT125 SOHC Engine	04→07	CR8EH-9	5666			CR8EHIX-9	3797	0.9
	RT125D DOHC Engine	07→	CR8E	1275			CR8EIX	4218	0.8
	RX125 SOHC Engine	00→07	CR8EH-9	5666			CR8EHIX-9	3797	0.9
	RX125D SM DOHC Engine	07→	CR8E	1275			CR8EIX	4218	0.8
	RX125D-E DOHC Engine	07→	CR8E	1275			CR8EIX	4218	0.8
XXR125 SOHC Engine	→07	CR8EH-9	5666			CR8EHIX-9	3797	0.8	
250	GT250, Comet	03→	CR8E	1275			CR8EIX	4218	0.8
	GT250 EFI, Comet	08→	CR8E	1275			CR8EIX	4218	0.8
	GT250R	06→08	CR8E	1275			CR8EIX	4218	0.8
	GT250R EFI	08→	CR8E	1275			CR8EIX	4218	0.8
	GV250, Aquila	00→	CR8E	1275			CR8EIX	4218	0.8
	GV250 EFI, Aquila	08→	CR8E	1275			CR8EIX	4218	0.8
	MS3-250	07→	CR8E	1275			CR8EIX	4218	0.8
650	GT650, Comet	03→	CR8E	1275			CR8EIX	4218	0.8
	GT650 EFI, Comet	08→	CR8E	1275			CR8EIX	4218	0.8
	GT650R	06→08	CR8E	1275			CR8EIX	4218	0.8
	GT650R EFI	08→	CR8E	1275			CR8EIX	4218	0.8
	GT650S	06→08	CR8E	1275			CR8EIX	4218	0.8
	GV650, Aquila	06→08	CR8E	1275			CR8EIX	4218	0.8
	GV650 EFI, Aquila	08→	CR8E	1275			CR8EIX	4218	0.8

2 Wheel



CC	MODEL	DATE	STANDARD COPPER CORE	STOCK NUMBER	PLATINUM OR GOLD PALLADIUM	STOCK NUMBER	IRIDIUM	STOCK NUMBER	GAP MM
INDIAN									
1850	Dakota 4 - Classic, Highway, 4 si (Carb)		BPR6HS	7022			BPR6HIX	4085	0.6
	Dakota 4 - Classic, Highway, 4 si (Injection)		BPR7HS	6422			BPR7HIX	5944	0.6

ITALJET									
50	Dragster D50 LC (Liquid Cooled)	98→04	BR8HS	4322			BR8HIX	7001	0.6
	Formula 50, 50 A, Formula 50 Williams (Air Cooled)	96→04	BPR6HS	7022			BPR6HIX	4085	0.6
	Formula 50 LC	98→04	BR7HS	4122			BR7HIX	7067	0.6
	Jetset 50 2T	01→04	BR9ES	5722			BR9EIX	3981	0.7
	Torpedo 50/T50	97→04	BPR6HS	7022			BPR6HIX	4085	0.6
	Velocifero 50/V50	96→	BPR6HS	7022			BPR6HIX	4085	0.6
100	Millennium 100	00→04	BR7HS	4122			BR7HIX	7067	0.6
125	Dragster D125LC (2-Stroke Liquid Cooled)	99→04	BR9ES	5722			BR9EIX	3981	0.7
	Formula 125 LC (Liquid Cooled)	97→04	BR7HS	4122			BR7HIX	7067	0.6
	Jetset 125 4T	01→04	CR7E	4578			CR7EIX	7385	0.6
	Millennium (4-Stroke Liquid Cooled)	00→04	CR8E	1275			CR8EIX	4218	0.7
	Torpedo T125 4T		CR8E	1275			CR8EIX	4218	0.6
150	Jetset 150 4T	01→04	CR7E	4578			CR7EIX	7385	0.6
	Millennium 150	00→04	CR7E	4578			CR7EIX	7385	0.6
176	Dragster D180LC (2-Stroke Liquid Cooled)	99→04	BR9ES	5722			BR9EIX	3981	0.7
250	Jupiter 250	01→04	DR8EA	7162	DR8EVX	6354	DR8EIX	6681	0.7

JAWA-CZ									
50	Jawa Economy, Jive, Jazz		B6HS	4510			BR6HIX	3419	0.5
	MJ50, Korado Basic/K'start, Lux		B6HS	4510			BR6HIX	3419	0.5
125	CZ125	→84	B8HS	5510	B8HVX	2634	BR8HIX	7001	0.5
	CZ125 Oilmaster	84→	B8HS	5510	B8HVX	2634	BR8HIX	7001	0.5
175	CZ175	→84	B8HS	5510	B8HVX	2634	BR8HIX	7001	0.5
	CZ175	84→	B8HS	5510	B8HVX	2634	BR8HIX	7001	0.5
180	CZ180	84→	B8HS	5510	B8HVX	2634	BR8HIX	7001	0.5
250	CZ250 Single/DeLuxe	→84	B8HS	5510	B8HVX	2634	BR8HIX	7001	0.5
	CZ250	84→	B8HS	5510	B8HVX	2634	BR8HIX	7001	0.5
350	CZ350	→84	B8HS	5510	B8HVX	2634	BR8HIX	7001	0.5
	CZ350 Classic/Style/Sport/Chopper	84→	B8HS	5510	B8HVX	2634	BR8HIX	7001	0.7
500	Jawa 500R	86→90	D8EA	2120	D8EVX	2850	DR8EIX	6681	0.5

JIALING									
50	CJ50F/K		BPR6HS	7022			BPR6HIX	4085	0.7
	JD 50, JL 50	97→00	BPR6HSA	4632			BPR6HIX	4085	0.6
	JH 50	95→	C7HSA	4629			CR7HIX	7544	0.7
	LX50		BPR6HSA	4632			BPR6HIX	4085	0.7
	QM 50		BPR4HS	7823					0.7
	TA 55		BPR6HSA	4632			BPR6HIX	4085	0.7
	70	CJ70		CR7HSA	4549			CR7HIX	7544
JD 70, JH 70		94→00	C7HSA	4629			CR7HIX	7544	0.7
90	JH 90	94→96	C6HSA	3228			CR6HIX	7274	0.7
	K 90		BP7HS	5111			BPR7HIX	5944	0.7
100	K100		BP7HS	5111			BPR7HIX	5944	0.7
	QM100		BP7HS	5111			BPR7HIX	5944	0.7
125	JH125	94→02	DR8ES-L	2923	DR8EVX	6354	DR8EIX	6681	0.7
	Sanyang Duke 125		DPR7EA-9	5129	DPR7EVX-9	7682	DPR7EIX-9	7803	0.9
	Sanyang Wolf 125		DR8ES-L	2923	DR8EVX	6354	DR8EIX	6681	0.7

JIANSHE									
125	JS125Y Tiger	03→	DR8ES	5423	DR9EVX	6361	DR9EIX	4772	0.7

JINLUN									
50	JL50QT	04→	CR7HSA	4549			CR7HIX	7544	0.7
125	Hornet 125	08→	CR7HSA	4549			CR7HIX	7544	0.7
	JL125-11/13	06→	CR7HSA	4549			CR7HIX	7544	0.7



CC	MODEL	DATE	STANDARD COPPER CORE	STOCK NUMBER	PLATINUM OR GOLD PALLADIUM	STOCK NUMBER	IRIDIUM	STOCK NUMBER	GAP MM
JINLUN (CONTINUED)									
125	JL125-C/Y	05→	CR7HSA	4549			CR7HIX	7544	0.7
	JL125T	05→	CR7HSA	4549			CR7HIX	7544	0.7
150	JL150	05→	D8EA	2120	DR8EVX	6354	DR8EIX	6681	0.7
250	JL250	06→	CR7HSA	4549			CR7HIX	7544	0.7

KAWASAKI									
50	AE50 A1/A2,AR50 A1/C1-C10	81→97	B6ES	7310					0.7
60	KX60 A, B1-B13	83→97	B9EG	3530	B9EGV	5827	BR9EIX	3981	0.7
	KX60 B14-B17	98→01	BR9EG	3230			BR9EIX	3981	0.5
65	KX65 A1-A6	00→05	BR10EG	3830			BR10EIX	6801	0.7
80	AE80 A, AR80 A	81→82	BP8ES	2912	BP8EVX	2671	BPR8EIX	6684	0.7
	AE80 B, AR80 C1-C8	83→93	BPR8ES	3923					0.7
	KX80 A, B	79→80	B8EG	3430	B8EGV	5627	BR8EIX	5044	0.5
	KX80 C-R1	81→91	BR9EG	3230			BR9EIX	3981	0.5
	KX80 R2-R7	92→97	R6252K-105	2741					0.7
	KX80 W1, W2	98→99	R6252K-105	2741					0.7
	KX80 W3	00→	R6252K-105	2741					0.7
85	KX85 A1-A5/B1-B5	01→05	R6252K-105	2741					0.7
	KX85 A6F/B6F	06	R6252K-105	2741					0.7
90	KM90A	73→80	B7HS	5110			BR7HIX	7067	0.5
100	G7TA	73→76	B8HS	5510	B8HVX	2634	BR8HIX	7001	0.6
	KC100 C1-C4	79→86	B8ES	2411	B8EVX	7051	BR8EIX	5044	0.7
	KE100 A7-A10,B1-B15	78→99	BR8ES	5422			BR8EIX	5044	0.7
	KH100 A1-A4 (KH100EL)	77→81	B8ES	2411	B8EVX	7051	BR8EIX	5044	0.7
	KH100 G2-G8 (KH100EX)	81→93	B8ES	2411	B8EVX	7051	BR8EIX	5044	0.7
	KM100 A1-A4, A6-A7	76→81	B7HS	5110			BR7HIX	7067	0.6
	KX100 A1-A2, B1	89→91	BR9EG	3230			BR9EIX	3981	0.5
	KX100 B2-B7	92→97	R6252K-105	2741					0.7
	KX100 C1-C3	98→00	R6252K-105	2741					0.7
	KX100 D1-D5, D6F-D9F	01→09	R6252K-105	2741					0.7
110	KLX110 A1/A2	02→	CR6HSA	2983			CR6HIX	7274	0.6
	KSR110	03→	CR6HSA	2983			CR6HIX	7274	0.6
125	AR125 A1, A1A, A1B, A2-A7, B1-B8	82→94	BR8ES	5422			BR8EIX	5044	0.7
	BN125 A1-A8 (Eliminator)	98→05	CR7E	4578			CR7EIX	7385	0.7
	BN125 A6F-A7F, A9F (Eliminator)	06→	CR7E	4578			CR7EIX	7385	0.7
	KDX125 A1/A2,B1/B2	90→94	BR8ES	5422			BR8EIX	5044	0.7
	KE125 A3-A6	76→79	B8HS	5510	B8HVX	2634	BR8HIX	7001	0.6
	KE125 A7-A8	80→81	B8ES	2411	B8EVX	7051	BR8EIX	5044	0.7
	KE125 A9-A12	82→87	B9ES	2611	B9EVX	7254	BR9EIX	3981	0.7
	KH125 A/L/K/K4/K7-K9	82→99	BR8ES	5422			BR8EIX	5044	0.7
	KMX125 A1-A5/B1-B12	86→02	BR8ES	5422			BR8EIX	5044	0.7
	KX125 A1-A5	74→79	B9EG	3530	B9EGV	5827	BR9EIX	3981	0.6
	KX125 A6-A7, B1	80→82					BR9EIX	3981	0.6
	KX125 B2, D-G, H1	83→90	BR10EG	3830			BR10EIX	6801	0.6
	KX125 H2	91	R6252E-105	2396					0.6
	KX125 J1, J2	92→93	R6252K-105	2741					0.7
	KX125 K1-K5, L1-L4	94→02					BR9EIX	3981	0.6
	KX125 M1	03					BR9EIX	3981	0.6
	KX125 M2-M3	04→05			R6918B-9	2954			0.8
KX125 M6, M7F	06→			BR9ECMVX	2434			0.8	
KDX125 A1-A2	80→81	B9ES	2611	B9EVX	7254	BR9EIX	3981	0.7	
175	KDX175 A3, B1-B2	82→83					BR9EIX	3981	0.6
	KE175 B1-B3	76→79	B9HS	5810	B9HVX	2254			0.6
	KE175 D1	79	B9ES	2611	B9EVX	7254	BR9EIX	3981	0.6
	KE175 D2-D5	80→84	B7ES	1111			BR7EIX	6664	0.7
200	KDX200 E1-E6	89→94	BR9ES	5722			BR9EIX	3981	0.7
	KDX200 H1-H10	95→04	BR8ES	5422			BR8EIX	5044	0.7
	KMX200 A2-A4	88→90	BR8ES	5422			BR8EIX	5044	0.7
	Z200 A1-A4	77→81	B7ES	1111			BR7EIX	6664	0.7
	Z200 A5-A6	82→88	BR7ES	5122			BR7EIX	6664	0.7
220	KDX220 A4-A7	97→00	BR8ES	5422			BR8EIX	5044	0.7
	KDX220 A8-A12	01→05	BR8ES	5422			BR8EIX	5044	0.7
250	A1 (Samurai)	67→71	B8HS	5510	B8HVX	2634	BR8HIX	7001	0.6
	EL250 D4-D5	93→96	CR8HSA	2086	CR8HVX	7236	CR8HIX	7669	0.7



CC	MODEL	DATE	STANDARD COPPER CORE	STOCK NUMBER	PLATINUM OR GOLD PALLADIUM	STOCK NUMBER	IRIDIUM	STOCK NUMBER	GAP MM	
KAWASAKI (CONTINUED)										
250	EL250 F2 (EL252)	97→99	CR8HSA	2086	CR8HVX	7236	CR8HIX	7669	0.7	
	ER250 B1-B3 (Z250T)	83→90	DPR9EA-9	5329			DPR9EIX-9	5545	0.9	
	EX250 F2-F8 (GPX250), H1-H2 (ZZ-R250)	88→92	CR8HSA	2086	CR8HVX	7236	CR8HIX	7669	0.6	
	EX250 F9 (GPX250R)	95	CR8HSA	2086	CR8HVX	7236	CR8HIX	7669	0.6	
	EX250 K8F (Ninja 250R)	08→	CR8E	1275			CR8EIX	4218	0.7	
	F11	72→75	B9HS	5810	B9HVX	2254			0.6	
	KDX250 B2-B4, C1-C3	82→85	BR8ES	5422			BR8EIX	5044	0.7	
	KDX250 D1-D5, E1-E2	91→95	BR9ES	5722			BR9EIX	3981	0.7	
	KH250 B1-B5	76→82	B9HS	5810	B9HVX	2254			0.6	
	KL250 A1-A4	77→83	B7ES	1111			BR7EIX	6664	0.7	
	KL250 C1-C2	83→85	BR8ES	5422			BR8EIX	5044	0.7	
	KL250 D2-D11, D16 (KLR250)	85→01	DPR9EA-9	5329			DPR9EIX-9	5545	0.9	
	KLX250 B1-B2	81→82	BR7ES	5122			BR7EIX	6664	0.7	
	KLX250 D1-D2	93→94	CR8E	1275			CR8EIX	4218	0.7	
	KLX250 G1	94→97	CR8E	1275			CR8EIX	4218	0.7	
	KLX250 T9F	09→	CR8E	1275			CR8EIX	4218	0.7	
	KR250 C2, C3 (KR1-S)	90→92	BR10ES	4832			BR10EIX	6801	0.7	
	KX250 A1-A7, B1	75→82	BR9EG	3230			BR9EIX	3981	0.7	
	KX250 C1-C2, D1	83→85	BR8EG	3130			BR8EIX	5044	0.6	
	KX250 D2, E1, F1, G1, H1-H2	86→91	BR9EG	3230			BR9EIX	3981	0.7	
	KX250 J1-J2	92→93	R6252E-9	4741					0.6	
	KX250 K1-K5, L1-L4	94→02					BR8EIX	5044	0.6	
	KX250 M1-M2	03→04					BR8EIX	5044	0.6	
	KX250 R1, R6F-R7F	05→07				BR8ECMVX	5567		0.6	
	KX250 N1-N2 (KX250F Four Stroke)	04→05	CR8EB	7784			CR8EIX	4218	0.7	
	KX250 T6F-W9F (KX250F Four Stroke)	06→09	CR8E	1275			CR8EIX	4218	0.7	
	S1 A, B, C (Mach 1)	72→75	B9HS	5810	B9HVX	2254			0.6	
	Z250 A1-A3, B1-B2	79→82	DR8ES	5423	DR9EVX	6361	DR9EIX	4772	0.6	
	Z250 C1-C2, G1-G2 (Z50LTD)	80→83	B7ES	1111			BR7EIX	6664	0.7	
	300	KLX300 A2-A8, B1-B3	97→03	CR8E	1275			CR8EIX	4218	0.7
	305	EX305 A1 (GPz305)	83→84	DPR9EA-9	5329			DPR9EIX-9	5545	0.9
		EX305 B2-B10 (GPz305)	84→96	DPR9EA-9	5329			DPR9EIX-9	5545	0.9
	350	A7 (Avenger)	67→71	B9HS	5810	B9HVX	2254			0.6
S2, S2A (Mach II)		72→73	B9HS	5810	B9HVX	2254			0.6	
400	KH400 A3-A5	76→78	B8HS	5510	B8HVX	2634	BR8HIX	7001	0.7	
	KX400 A	75→76	B9EG	3530	B9EGV	5827	BR9EIX	3981	0.6	
	S3, S3A	74→75	B9HS	5810	B9HVX	2254			0.7	
	Z400 D3-D4	76→77	B8ES	2411	B8EVX	7051	BR8EIX	5044	0.7	
	Z400 B1-B2, G1	78→79	B7ES	1111			BR7EIX	6664	0.7	
	Z400 J1-J2	80→81	D8EA	2120	D8EVX	2850	DR8EIX	6681	0.7	
	Z400 J3	82→83	DR8EA	7162	DR8EVX	6354	DR8EIX	6681	0.7	
	ZR400 A (A400F)	83→84	DR8ES	5423	DR9EVX	6361	DR9EIX	4772	0.7	
	ZR400 B1	84→85	DPR9EA-9	5329			DPR9EIX-9	5545	0.9	
	ZX400 C2-C3	85→87	DPR9EA-9	5329			DPR9EIX-9	5545	0.9	
ZX400 L1-L9 (ZXR400)	91→99	CR9EK	4548			CR9EIX	3521	0.6		
420	KX420A	80→81	B9EG	3530	B9EGV	5827	BR9EIX	3981	0.6	
440	Z440 A2-A3 (LTD), C1-C2	80→82	BR7ES	5122			BR7EIX	6664	0.6	
	Z440 H1-H2, D4-D6 (LTD Belt Drive)	82→84	BR7ES	5122			BR7EIX	6664	0.6	
450	EN450 A1-A5 (Belt Drive)	85→90	DR8ES	5423	DR9EVX	6361	DR9EIX	4772	0.7	
	KX450 D6F	06→08	CPR8EB-9	6607					0.9	
	KX450F	09→	CPR8EB-9	6607					0.9	
500	EN500 A1-A3	90→93	DR8ES	5423	DR9EVX	6361	DR9EIX	4772	0.7	
	EN500 B2	94→	DR9EA	3437	DR9EVX	6361	DR9EIX	4772	0.7	
	EN500 C1	96→99	DR9EA	3437	DR9EVX	6361	DR9EIX	4772	0.7	
	ER500 A1-A4, C3, C4P (ER-5)	97→	DR9EA	3437	DR9EVX	6361	DR9EIX	4772	0.7	
	ER500 C5P (ER-5)	06→07	DR9EA	3437	DR9EVX	6361	DR9EIX	4772	0.7	
	EX500 A1-A6 (GPz500S)	87→93	DR8ES	5423	DR9EVX	6361	DR9EIX	4772	0.7	
	EX500 D1-D3, D5-D7 (GPZ500S)	94→00	DR9EA	3437	DR9EVX	6361	DR9EIX	4772	0.7	
	EX500 E10	02→04	DR9EA	3437	DR9EVX	6361	DR9EIX	4772	0.7	
	H1 (Mach III), H1A-H1F, KH500A8	69→76	B9HS-10	3626	B9HVX	2254			1.0	
	KLE500 A1-A13	91→03	DR9EA	3437	DR9EVX	6361	DR9EIX	4772	0.7	
	KLE500 B6F, B7F	05→	DR9EA	3437	DR9EVX	6361	DR9EIX	4772	0.7	
	KX500 A1-A2	83→84	BR9EG	3230			BR9EIX	3981	0.6	
	KX500 B, C, D, E1-E16	85→04	BR8EG	3130			BR8EIX	5044	0.5	
	Z500 B1-B4	79→82	D8EA	2120	D8EVX	2850	DR8EIX	6681	0.7	



CC	MODEL	DATE	STANDARD COPPER CORE	STOCK NUMBER	PLATINUM OR GOLD PALLADIUM	STOCK NUMBER	IRIDIUM	STOCK NUMBER	GAP MM
KAWASAKI (CONTINUED)									
550	Z550 A1-A3	80→83	DR8ES	5423	DR9EVX	6361	DR9EIX	4772	0.7
	Z550 C1-C2 (LTD)	81→83	D8EA	2120	D8EVX	2850	DR8EIX	6681	0.7
	Z550 D1 (GPZ550)	81→82	D8EA	2120	D8EVX	2850	DR8EIX	6681	0.7
	Z550 G1-G9 (GT550)	83→01	DR8ES	5423	DR9EVX	6361	DR9EIX	4772	0.7
	Z550 H1-H2 (GPZ550), ZR550 A1 (Z550F)	82→85	DR8ES	5423	DR9EVX	6361	DR9EIX	4772	0.7
	ZR550 B2-B6 (Zephyr 550)	91→98	DR9EA	3437	DR9EVX	6361	DR9EIX	4772	0.6
	ZX550 A2-A4 (GPZ550)	85→91	DPR9EA-9	5329			DPR9EIX-9	5545	0.9
600	KL600 A1	84→85	D8EA	2120	D8EVX	2850	DR8EIX	6681	0.7
	KL600 B1-B2, B4	85→90	DPR8EA-9	4929			DPR8EIX-9	2202	0.9
	ZL600 B1 (Eliminator 600)	95→97	DR9EA	3437	DR9EVX	6361	DR9EIX	4772	0.7
	ZX600 A1-A5 (GPZ600R)	85→90	DR9EA	3437	DR9EVX	6361	DR9EIX	4772	0.7
	ZX600 C1-C7 (GPX600R)	88→96	DR9EA	3437	DR9EVX	6361	DR9EIX	4772	0.7
	ZX600 D1-D3, E1-E12 (ZZ-R600)	90→04	CR9E	6263			CR9EIX	3521	0.7
	ZX600 E6F (ZZR600)	06→	CR9E	6263			CR9EIX	3521	0.7
	ZX600 F1-F3 (Ninja ZX6R)	95→97	CR9E	6263			CR9EIX	3521	0.7
	ZX600 G1-G2 (ZX-6R)	98→99	CR9E	6263			CR9EIX	3521	0.7
	ZX600 J1-J2 (ZX-6R)	00→01	CR9E	6263			CR9EIX	3521	0.7
	ZX600 K1H-N6F (Ninja ZX-6RR)	03→06	CR9E	6263			CR9EIX	3521	0.7
	ZX600 P7F-P8F, R9F (Ninja ZX-6R)	07→09	CR9E	6263			CR9EIX	3521	0.7
	636	ZX636 A1P, B1H-B2H (Ninja ZX-6R)	02→04	CR9E	6263			CR9EIX	3521
ZX636 C1H-C6F (Ninja ZX-6R)		05→06	CR9E	6263			CR9EIX	3521	0.7
650	EJ650 A1-A2, C1, C5, C6P (W650)	99→05	CR8E	1275			CR8EIX	4218	0.7
	ER650 A7F-C9F (ER-6n)	06→					CR9EIA-9	6289	0.9
	EX650 A7F-A8F, B7F-B8F (ER-6f)	06→					CR9EIA-9	6289	0.9
	KL650 A1-A3	87→90	DPR8EA-9	4929			DPR8EIX-9	2202	0.9
	KL650 B1-B3 (Tengai)	89→92	DPR8EA-9	4929			DPR8EIX-9	2202	0.9
	KL650 C1-C5 (KLR 650)	94→02	DPR8EA-9	4929			DPR8EIX-9	2202	0.9
	KLE650 A7F, B7F (Versys)	07→					CR9EIA-9	6289	0.9
	KLX650 C1-C2	93→96	DPR8EA-9	4929			DPR8EIX-9	2202	0.9
	Z650 B1-B3, C2-C3 (Custom)	77→79	B7ES	1111			BR7EIX	6664	0.7
	Z650 D2-D3 (SR)	79→82	B7ES	1111			BR7EIX	6664	0.7
	Z650 F1-F4	82→84	B7ES	1111			BR7EIX	6664	0.7
750	H2 (Mach IV), H2A, H2B, H2C	72→75	B9HS-10	3626	B9HVX	2254			1.0
	VN750 A2-A10 (Vulcan)	86→94	DPR7EA-9	5129	DPR7EVX-9	7682	DPR7EIX-9	7803	0.9
	Z750 B1-B2	76→77	B8ES	2411	B8EVX	7051	BR8EIX	5044	0.7
	Z750 E1, H1-H2 (LTD), L1-L4	80→85	BR8ES	5422			BR8EIX	5044	0.7
	Z750 P1-P5 (GT750)	82→92	BR8ES	5422			BR8EIX	5044	0.7
	Z750 P7-P9 (GT750)	91→96	DR8ES	5423	DR9EVX	6361	DR9EIX	4772	0.6
	Z750 R1 (GP)	82→83	BR8ES	5422			BR8EIX	5044	0.7
	Z750 Y1 (LTD Twin)	82→83	BPR6ES	7822			BPR6EIX	6637	0.7
	ZR750 C1-C4 (Zephyr 750)	91→94	DR8ES	5423	DR9EVX	6361	DR9EIX	4772	0.6
	ZR750 C5 (Zephyr 750)	1995	DR9EA	3437	DR9EVX	6361	DR9EIX	4772	0.7
	ZR750 D1 (Zephyr 750)	96→99	DR9EA	3437	DR9EVX	6361	DR9EIX	4772	0.7
	ZR750 F1-F5 (ZR-7), H1-H3 (ZR-7S)	05/99→03	DR9EA	3437	DR9EVX	6361	DR9EIX	4772	0.7
	ZR750 J1H (Z750)	04→	CR9EK	4548			CR9EIX	3521	0.6
	ZR750 J6F (Z750)	05→	CR9EK	4548			CR9EIX	3521	0.6
	ZR750 K6F (Z750s)	06→	CR9EK	4548			CR9EIX	3521	0.6
	ZR750 L7F/M7F (Z750)	03/07→	CR9EK	4548			CR9EIX	3521	0.6
	ZX750 A1-A3, A5 (Z750GP)	83→89	BR9ES	5722			BR9EIX	3981	0.7
	ZX750 E1-E2 (Turbo)	83→87					BR9EIX	3981	0.6
	ZX750 F1-F5 (GPX750R)	87→91	DR8ES	5423	DR9EVX	6361	DR9EIX	4772	0.7
	ZX750 G2-G3	84→87	D8EA	2120	D8EVX	2850	DR8EIX	6681	0.7
	ZX750 H1-H2 (ZXR750)	89→91	CR9E	6263			CR9EIX	3521	0.7
	ZX750 J1-J2 (ZXR750)	91→93	CR9E	6263			CR9EIX	3521	0.7
	ZX750 M1-M2 (ZXR750R)	92→94	CR9E	6263			CR9EIX	3521	0.7
	ZX750 L3 (ZXR750)	94→96	CR9E	6263			CR9EIX	3521	0.7
	ZX750 N1 (Ninja ZX-7RR)	96→99	CR9E	6263			CR9EIX	3521	0.7
	ZX750 P1-P7 (Ninja ZX-7R)	96→03	CR9E	6263			CR9EIX	3521	0.7
	800	VN800 A1-3	95→98	CR7E	4578			CR7EIX	7385
VN800 B2-B8 (Classic), C1-C2, E1-E2 (Drifter)		96→	CR7E	4578			CR7EIX	7385	0.8
900	VN900 A6F, B7F (Classic)	06→	CPR7EA-9	3901					0.9
	VN900 C7F (Custom)	07→	CPR7EA-9	3901					0.9
	Z1, Z1A, Z1B, Z900 A4	73→76	B8ES	2411	B8EVX	7051	BR8EIX	5044	0.7
	ZX900 A1-A8 (GPZ900R)	84→96	DR8ES	5423	DR9EVX	6361	DR9EIX	4772	0.7



CC	MODEL	DATE	STANDARD COPPER CORE	STOCK NUMBER	PLATINUM OR GOLD PALLADIUM	STOCK NUMBER	IRIDIUM	STOCK NUMBER	GAP MM
KTM (CONTINUED)									
65	65 SX	→03	BR10EG	3830			BR10EIX	6801	0.6
	65 SX Beta engine 19mm Thread Reach	03→07	BR8ECM	3035	BR8ECMVX	5567			0.6
	65 SX KTM engine 12.7mm Thread Reach	08/08→	LR8B	6208	CR8HVX	7236	CR8HIX	7669	0.6
80	Moto-X models with 1/2", 12.7mm Thread Reach	→85			B8HVX	2634	BR8HIX	7001	0.6
	80 MX	86	B10EG	3630	B10EGV	5927	BR10EIX	6801	0.6
85	85 SX	03→06			BR10ECMVX	2457			0.7
	85 SX	07→			BR9ECMVX	2434			0.6
125	Moto-X models with 1/2", 12.7mm Thread Reach (Not GP)	→85			B8HVX	2634	BR8HIX	7001	0.6
	125 EXC, EGS, SX	98→00			R6918B-8	4492			0.8
	125 EXC, SX	01→07					BR9EIX	3981	0.6
	125 EXC, EXC, SX, Six Day	08→			BR9ECMVX	2434			0.6
	125 GS	86	B10EG	3630	B10EGV	5927	BR10EIX	6801	0.6
	125 LC/LCPA	→85	B9EG	3530	B9EGV	5827	BR9EIX	3981	0.6
	125 MX	86	B10EG	3630	B10EGV	5927	BR10EIX	6801	0.6
	125 MX	87/88	B9EG	3530	B9EGV	5827	BR9EIX	3981	0.6
	125 MX	89/90			B10EVX	7335	BR10EIX	6801	0.6
	125 SM		BR8HS	4322			BR8HIX	7001	0.6
	LC125, LC 2 125, Duke125		BR9ES	5722			BR9EIX	3981	0.6
	SX 125 (2001)	01→			BR9ECMVX	2434			0.6
	144	144 SX	08→			BR9ECMVX	2434		
150 SX		09→			BR9ECMVX	2434			0.6
175	Moto-X models with 1/2", 12.7mm Thread Reach	→85			B8HVX	2634	BR8HIX	7001	0.6
200	200 EGS, EXC, MXC	98→	BR8EG	3130			BR8EIX	5044	0.6
	200 EXC, SX	03→					BR9EIX	3981	0.6
	200 EXC	06→	BR8EG	3130			BR8EIX	5044	0.6
	200 XC, XC-W	07→	BR8EG	3130			BR8EIX	5044	0.6
250	Moto-X models with 1/2", 12.7mm Thread Reach	→85			B8HVX	2634	BR8HIX	7001	0.6
	250 EXC Ø 14mm Plug	97→	BR8ECM	3035	BR8ECMVX	5567			0.6
	250 EXC (2-Stroke) Ø14mm Plug	06→	BR7ES	5122			BR7EIX	6664	0.7
	250 EXC Ø 10mm Plug	02→	CR8EK	3478			CR8EIX	4218	0.7
	250 EXC Racing (4-Stroke) Ø12mm Plug	03→	DCPR8E*	4179			DCR8EIX	3606	0.6
	250 EXC-F (4-Stroke)	07→	CR9EKB	2305			CR9EIX	3521	0.7
	250 GS	86	B10EG	3630	B10EGV	5927	BR10EIX	6801	0.6
	250 LCPA	→85	B10EG	3630	B10EGV	5927	BR10EIX	6801	0.6
	250 MC/GS	→85	B9EG	3530	B9EGV	5827	BR9EIX	3981	0.6
	250 MX	86	B10EG	3630	B10EGV	5927	BR10EIX	6801	0.6
	250 MX	87/88	B9EG	3530	B9EGV	5827	BR9EIX	3981	0.6
	250 MX	89/90			B9EVX	7254	BR9EIX	3981	0.6
	250 SX	97→	BR8ECM	3035	BR8ECMVX	5567			0.6
	250 SX	03→05	BR8ECM	3035	BR8ECMVX	5567			0.6
	250 SX	06→	BR8ECM	3035	BR8ECMVX	5567			0.6
250 SX-F (4-Stroke)	06→	CR9EKB	2305			CR9EIX	3521	0.7	
300	300 EXC	97→02	BR8ECM	3035	BR8ECMVX	5567			0.6
	300 EXC	03→06	BR7ES	5122			BR7EIX	6664	0.7
	300 EXC	07→	BR7ES	5122			BR7EIX	6664	0.7
	300 GS	86	B10EG	3630	B10EGV	5927	BR10EIX	6801	0.6
	300 MXC	97→02	BR8ECM	3035	BR8ECMVX	5567			0.6
	300 MXC	03→	BR7ES	5122			BR7EIX	6664	0.7
	300 XC	06→	BR7ES	5122			BR7EIX	6664	0.7
350	350 MX	87→95	B9EG	3530	B9EGV	5827	BR9EIX	3981	0.6
380	380 EXC, 380 SX		BR8ECM	3035	BR8ECMVX	5567			0.6
390	390 GS	→85	B9EG	3530	B9EGV	5827	BR9EIX	3981	0.6
400	Moto-X models with 1/2", 12.7mm Thread Reach	→85	B9HS	5810	B9HVX	2254			0.7
	400 EGS-E	97→	DR8EA	7162	DR8EVX	6354	DR8EIX	6681	0.6
	400 EXC, MXC, SX (Ø10mm Plug)	99→	CR8EK	3478			CR8EIX	4218	0.7
	400 EXC (Ø12mm Plug)	02→	DCPR8E*	4179			DCR8EIX	3606	0.6
	400 LSE		DR8EA	7162	DR8EVX	6354	DR8EIX	6681	0.6
	LC4 400		DR8EA	7162	DR8EVX	6354	DR8EIX	6681	0.7
420	420 AC	→85	B9EG	3530	B9EGV	5827	BR9EIX	3981	0.6
450	450 EXC Racing, SX Racing (4-Stroke)	03→	DCPR8E*	4179			DCR8EIX	3606	0.6
	450 EXC-R	08→	LKAR8A-9	4786					0.9
	450 SMR	04→	DCPR8E*	4179			DCR8EIX	3606	0.6
	450 SX-F	07→	CR9EKB	2305			CR9EIX	3521	0.7



* Please note DCPR8E 4339 has a removable terminal nut, whereas DCPR8E 4179 has a fixed terminal nut



2 Wheel



CC	MODEL	DATE	STANDARD COPPER CORE	STOCK NUMBER	PLATINUM OR GOLD PALLADIUM	STOCK NUMBER	IRIDIUM	STOCK NUMBER	GAP MM
KTM (CONTINUED)									
480	505 SX-F	07→	CR9EKB	2305			CR9EIX	3521	0.7
495	495 AC	→85	B9EG	3530	B9EGV	5827	BR9EIX	3981	0.6
500	500 MX, 500 MXC	86	B9EG	3530	B9EGV	5827	BR9EIX	3981	0.6
	500 MX	87/88	B9EG	3530	B9EGV	5827	BR9EIX	3981	0.6
	500 MX	89/90			B9EVX	7254	BR9EIX	3981	0.6
510	530 EXC-R	07→	LKAR8A-9	4786					0.9
520	520 EXC, MXC, SX	99→	CR8EK	3478			CR8EIX	4218	0.7
525	525 EXC Racing, MXC, SX	03→	DCPR8E*	4179			DCR8EIX	3606	0.6
560	560-4S	→85	D8EA	2120	D8EVX	2850	DR8EIX	6681	0.6
600	600-C4S	→85	D8EA	2120	D8EVX	2850	DR8EIX	6681	0.6
	600 4S	86	D8EA	2120	D8EVX	2850	DR8EIX	6681	0.6
	600 4S	87/88	D8EA	2120	D8EVX	2850	DR8EIX	6681	0.6
	600 EGS-E		DR8EA	7162	DR8EVX	6354	DR8EIX	6681	0.6
	LC4 640		DR8EA	7162	DR8EVX	6354	DR8EIX	6681	0.7
620	620 Adventure, 620LSE, 620 Duke	97→	DR8EA	7162	DR8EVX	6354	DR8EIX	6681	0.6
625	625 Enduro, Super Moto	02→	DPR8EA-9	4929			DPR8EIX-9	2202	0.9
	625 SMC	03→06	DCPR8E*	4179			DCR8EIX	3606	0.6
	625 SXC	03→	DCPR8E*	4179			DCR8EIX	3606	0.6
	640 LC4, Duke, Duke II	03→	DCPR8E*	4179			DCR8EIX	3606	0.6
	640 Super Moto	02→	DCPR8E*	4179			DCR8EIX	3606	0.6
	R640 Adventure	03→	DCPR8E*	4179			DCR8EIX	3606	0.6
654	660 SMC	03→	DCPR8E*	4179			DCR8EIX	3606	0.6
	690 Duke	07→					LKAR8AI-9	6706	0.9
	690 LC4 Supermoto / Prestige	07→					LKAR8AI-9	6706	0.9
	690 SMC	08→					LKAR8AI-9	6706	0.9
	690 SM R	08→					LKAR8AI-9	6706	0.9
	690 Enduro R	09→					LKAR8AI-9	6706	0.9
950	950 Adventure/Rally	03→	CR8EK	3478			CR8EIX	4218	0.7
	950 Supermoto / Super Enduro R	05→	CR8EK	3478			CR8EIX	4218	0.7
1000	990 Adventure / Supermoto	06→	DCPR8E*	4339			DCR8EIX	3606	0.9
	990 SM-R/T	09→					KR8DI	4742	0.8
	990 Super Duke	04→	DCPR8E*	4339			DCR8EIX	3606	0.9
	990 Super Duke / R	07→					KR8DI	4742	0.8
	990 LC8 Super Duke R	08→					LKAR8AI-9	6706	0.9
1148	1190 RC8	08→					LKAR9BI9	6205	0.9
1195	RC8R	09→					LKAR9BI9	6205	0.9

KYMCO									
50	Agility 50	05→	CR7HSA	4549			CR7HIX	7544	0.7
	Cobra 50		BR8HSA	5539			BPR8HIX	6742	0.6
	Fever 50		BR8HSA	5539			BPR8HIX	6742	0.6
	Filly 50	98→	CR7HSA	4549			CR7HIX	7544	0.7
	Filly LX 50	99→	CR7HSA	4549			CR7HIX	7544	0.7
	People 50	04→06	BR8HSA	5539			BPR8HIX	6742	0.6
	Scout 50	97→	BR8HSA	5539			BPR8HIX	6742	0.6
	Spacer 50		BR8HSA	5539			BPR8HIX	6742	0.6
	Super 9 50 (Liquid Cooled)	99→	BR8HSA	5539			BPR8HIX	6742	0.6
	Super 9 50 (Air Cooled)	01→	BR8HSA	5539			BPR8HIX	6742	0.6
	Super 9 50 (Air Cooled Euro 2)	01→	BR8HSA	5539			BPR8HIX	6742	0.6
	Vitality 50 (2-Stroke)	04→	BR8HSA	5539			BPR8HIX	6742	0.6
	Vitality 50 (4-Stroke)		CR7HSA	4549			CR7HIX	7544	0.7
	Yup 50	00→	BR8HSA	5539			BPR8HIX	6742	0.6
	ZX 50		BR8HSA	5539			BPR8HIX	6742	0.6
	100	Cobra 100	99→	BR6HSA	4296			BPR6HIX	4085
125	Agility 125	05→	CR7HSA	4549			CR7HIX	7544	0.7
	CK125	05→	DR8EA	7162	DR8EVX	6354	DR8EIX	6681	0.7
	Cruiser 125	03→	CR8E	1275			CR8EIX	4218	0.7
	Ego 125		DPR7EA-9	5129	DPR7EVX-9	7682	DPR7EIX-9	7803	0.9
	Heroism 125		C7HSA	4629			CR7HIX	7544	0.7
	Hipster 125 (2 Valve)	01→	DR8EA	7162	DR8EVX	6354	DR8EIX	6681	0.7
	Hipster 125 (4 Valve)		CR8E	1275			CR8EIX	4218	0.7
Hipster 125 (4 Valve) Euro2		CR8E	1275			CR8EIX	4218	0.7	



* Please note DCPR8E 4339 has a removable terminal nut, whereas DCPR8E 4179 has a fixed terminal nut



2 Wheel



CC	MODEL	DATE	STANDARD COPPER CORE	STOCK NUMBER	PLATINUM OR GOLD PALLADIUM	STOCK NUMBER	IRIDIUM	STOCK NUMBER	GAP MM
KAWASAKI (CONTINUED)									
900	ZX900 B1-B4 (ZX9R Ninja)	94→98	CR9EK	4548			CR9EIX	3521	0.6
	ZX900 C1-C2, E1-E2 (ZX9R Ninja)	98→	CR9EK	4548			CR9EIX	3521	0.7
	ZX900 F1, F2P Fuel Injection (ZX9R)	02→04	CR9EK	4548			CR9EIX	3521	0.7
1000	KLV1000	05→	CR8EK	3478			CR8EIX	4218	0.7
	Z1000 A1-A3, A4 (Mark II), D1 (Z1-R), E1-E2 (ST), H1 (Fi)	77→81	B8ES	2411	B8EVX	7051	BR8EIX	5044	0.7
	Z1000 J1-J3, R1-R2, K1 (LTD)	81→84	B8ES	2411	B8EVX	7051	BR8EIX	5044	0.7
	ZG1000 A1-A7 (1000GTR)	86→94	DR8ES	5423	DR9EVX	6361	DR9EIX	4772	0.7
	ZG1000 A9-A14 (1000GTR)	94→99	DR9EA	3437	DR9EVX	6361	DR9EIX	4772	0.7
	ZL1000 A1 (ZL1000)	87→90	DR8ES	5423	DR9EVX	6361	DR9EIX	4772	0.7
	ZR1000 A1H-A3H (Z1000)	03→05	CR9EK	4548			CR9EIX	3521	0.7
	ZR1000 A6F (Z1000)	06→07	CR9EK	4548			CR9EIX	3521	0.7
	ZR1000 B7F-B8F, C7F-C8F (Z1000)	07→					CR9EIA-9	6289	0.9
	ZX1000 A1-A3 (GPZ1000RX)	85→89	DR8ES	5423	DR9EVX	6361	DR9EIX	4772	0.7
	ZX1000 B1-B3 (ZX-10)	88→91	CR9E	6263			CR9EIX	3521	0.7
	ZX1000 C1H (ZX10R)	04→					CR9EIA-9	6289	0.9
	ZX1000 D6F-D7F, E8F (Ninja ZX-10R)	06→					CR9EIA-9	6289	0.9
1100	Z1100 A1-A3 (Shaft drive)	81→85	BR8ES	5422			BR8EIX	5044	0.7
	Z1100 B1-B2 (Z1100GP)	81→83	BR8ES	5422			BR8EIX	5044	0.7
	ZR1100 A1-A4 (Zephyr)	92→	CR9E	6263			CR9EIX	3521	0.7
	ZR1100 B1 (Zephyr)	96→97	CR9E	6263			CR9EIX	3521	0.7
	ZR1100 C1-C4 (ZRX 1100)	97→01	CR9EK	4548			CR9EIX	3521	0.7
	ZX1100 A1-A3 (Z1100GP)	83→88	BR8ES	5422			BR8EIX	5044	0.7
	ZX1100C1-C3, D1-D9 (ZZ-R1100)	90→01	CR9E	6263			CR9EIX	3521	0.7
	ZX1100 E1-E2 (GPZ1100)	95→99	CR9EK	4548			CR9EIX	3521	0.7
	ZX1100 F1 (GPZ1100 ABS)	96→98	CR9EK	4548			CR9EIX	3521	0.8
	1200	ZR1200 A1-A4H, B1-B3P (ZRX 1200)	01→05	CR9EK	4548			CR9EIX	3521
ZR1200 A6F (ZRX1200R)		05→	CR9EK	4548			CR9EIX	3521	0.7
ZX1200 A1-A2 (ZX-12R)		99→01			CR9EKPA	7785	CR9EIX	3521	0.8
ZX1200 B1H-B3H (Ninja ZX-12R)		02→07			CR9EKPA	7785	CR9EIX	3521	0.8
ZX1200-C1H/C2H (ZZ-R1200)		02→04	CR9E	6263			CR9EIX	3521	0.7
1300	Z1300 A1	78→79	BR8ES	5422			BR8EIX	5044	0.7
	Z1300 A2-A5	80→83	BPR6ES	7822			BPR6EIX	6637	0.7
	ZG1300 A1-A3 Fuel Injection	84→90	BPR6ES	7822			BPR6EIX	6637	0.7
1400	ZG1400 A8F (1400GTR)	07→					CR9EIA-9	6289	0.9
	ZX1400 A6F-A7F, B7F, D8F (ZZ-R1400)	06→					CR9EIA-9	6289	0.9
1500	VN1500 B2-B6, C1-C2	88→95	DPR7EA-9	5129	DPR7EVX-9	7682	DPR7EIX-9	7803	0.9
	VN1500 D1-D2 (VN1500 Classic)	96→98	DPR5EA-9	2887					0.9
	VN1500 E1-E2 (Classic)	98→99	DPR5EA-9	2887					0.8
	VN1500 G2 (Nomad)	99	DPR5EA-9	2887					0.8
	VN1500 J1-J2 Drifter	99→00	DPR6EA-9	5531					0.9
	VN1500 L1-L4 Fi (Classic Tourer Fi)	99→03	DPR6EA-9	5531					0.9
	VN1500 N1-N3H	99→04	DPR6EA-9	5531					0.9
	VN1500 P1H-P2H (Mean Streak)	01→04	DPR6EA-9	5531					0.9
1552	VN1600 A1H-A7F Classic	03→07	DPR6EA-9	5531					0.9
	VN1600 B1H-B7F Mean Streak	04→07	DPR6EA-9	5531					0.9
	VN1600 D1H-D8F Classic Tourer	05→08	DPR6EA-9	5531					0.9
1700	VN1700 (Classic/Tourer, Voyager)	09→					ILZKAR7B11	1654	1.1
2050	VN2000 A1H-A6F	04→					IZFR6F11	4095	1.1

KREIDLER

50	Florett (RM,RMS,RMC) GS50		B7HS	5110			BR7HIX	7067	0.5
	MC-5-50		B7HS	5110			BR7HIX	7067	0.5

KTM

50	50 (2000 model) Pro-Junior (12.7mm Thread Reach)	00	B8HS	5510	B8HVX	2634	BR8HIX	7001	0.6
	50 (2000 model) Pro-Senior (12.7mm Thread Reach)	00	B8HS	5510	B8HVX	2634	BR8HIX	7001	0.6
	50 Adventure Mini, Junior & Senior (12.7mm Thread Reach)	→02	BR8HS	4322			BR8HIX	7001	0.6
	50 Adventure Mini, Junior & Senior (19mm Thread Reach)	03→	BR8ECM	3035	BR8ECMVX	5567			0.6
	50 SX Junior/Senior LC (19mm Thread Reach)	02	BR10EG	3830			BR10EIX	6801	0.6
	50 SX Pro-Junior LC (Beta Engine)	03	BR8ECM	3035	BR8ECMVX	5567			0.6
60	60 SX	98→					R7436-10	4900	0.6



CC	MODEL	DATE	STANDARD COPPER CORE	STOCK NUMBER	PLATINUM OR GOLD PALLADIUM	STOCK NUMBER	IRIDIUM	STOCK NUMBER	GAP MM
KYMCO (CONTINUED)									
125	Miler 125 (Grand Dink)	03→	DPR7EA-9	5129	DPR7EVX-9	7682	DPR7EIX-9	7803	0.9
	Movie XL125	02→	CR7HSA	4549			CR7HIX	7544	0.7
	People S 125 Euro3	05→	CR7HSA	4549			CR7HIX	7544	0.7
	Pulsar 125		DR8EA	7162	DR8EVX	6354	DR8EIX	6681	0.7
	Sector 125		DR8EA	7162	DR8EVX	6354	DR8EIX	6681	0.7
	Spacer 125 (Water Cooled)		DPR7EA-9	5129	DPR7EVX-9	7682	DPR7EIX-9	7803	0.9
	Stryker 125		DR8EA	7162	DR8EVX	6354	DR8EIX	6681	0.7
	Super8 125	07→	DPR7EA-9	5129	DPR7EVX-9	7682	DPR7EIX-9	7803	0.9
	Vivio 125		CR7HSA	4549			CR7HIX	7544	0.7
	Yager GT125	08→	DPR7EA-9	5129	DPR7EVX-9	7682	DPR7EIX-9	7803	0.9
	Zing 125	97→	DR8EA	7162	DR8EVX	6354	DR8EIX	6681	0.7
250	Dink 250		DPR7EA-9	5129	DPR7EVX-9	7682	DPR7EIX-9	7803	0.9
	Ego 250		DPR7EA-9	5129	DPR7EVX-9	7682	DPR7EIX-9	7803	0.9
	Grand Dink 250	01→	DPR7EA-9	5129	DPR7EVX-9	7682	DPR7EIX-9	7803	0.9
	People 250	05→	DPR7EA-9	5129	DPR7EVX-9	7682	DPR7EIX-9	7803	0.9
	Venox 250	03→	CR8E	1275			CR8EIX	4218	0.7
500	Xciting 500i	05→	CR8E	1275			CR8EIX	4218	0.7

LAMBRETTA									
125	LI 125, SL125, SI 125		B7ES	1111			BR7EIX	6664	0.5
150	GP 150	76→98	B7ES	1111			BR7EIX	6664	0.5
200	GP 200, SXJet 200, SX200, Links 200	78→	B7ES	1111			BR7EIX	6664	0.5

LAVERDA									
500	500 Alpino S, Montjuic	78→84	D9EA	2420	D9EVX	2834	DR9EIX	4772	0.7
650	650 i.e, Sport, Formula, Ghost, Diamante	94→98	DCPR9E	2641	DCPR9EVX	6436	DCPR9EIX	2316	0.6
	650, GT, GTL, American Eagle	94→98	B9ES	2611	B9EVX	7254	BR9EIX	3981	0.7
668	668, Ghost, Ghost Strike	96→98	DCPR9E	2641	DCPR9EVX	6436	DCPR9EIX	2316	0.6
750	750, GT, GTL, American Eagle		B8ES	2611	B8EVX	7051	BR8EIX	5044	0.7
	750 S, Ghost 750 Strike, Diamante 750, 750 S Formula	97→02	DCPR9E	2641	DCPR9EVX	6436	DCPR9EIX	2316	0.6
	SF, SFL, SF2, SF3, SFC 1968→78 Twins	68→78	B8ES	2611	B8EVX	7051	BR8EIX	5044	0.7
1000	1000EC, 3C(E), 1000 2CL, Jota, Jarama	76→82	B8ES	2411	B8EVX	7051	BR8EIX	5044	0.7
	RGA, RGS	82→87	B8ES	2411	B8EVX	7051	BR8EIX	5044	0.7
	SFC	85→89	B9ES	2611	B9EVX	7254	BR9EIX	3981	0.7
1200	1200, T, Mirage, TS, Jota American	78→83	B8ES	2411	B8EVX	7051	BR8EIX	5044	0.7

LEM									
50	LX 1,2,3,4 Super & Sport 50 (12.7mm Thread Reach)		B7HS	5110			BR7HIX	7067	0.6
	LX4 (19mm Thread Reach)		BR9ES	5722			BR9EIX	3981	0.7
	S6 Racer (Reed valve engine) 50				B105EGV	2171			0.6

MAGNI									
1000	Australia		D9EA	2420	D9EVX	2834	DR9EIX	4772	0.7
	Sfida 1000		BP6ES	7811	BP6EVX	5832	BPR6EIX	6637	0.5
	Sfida Ottovalvole				D9EVX	2834	DR9EIX	4772	0.6

MAICO									
Various	Moto-X models with 1/2", 12.7mm Thread Reach				B9HVX	2254			0.5
	Moto-X models with 3/4", 19mm Thread Reach		B9EG	3530	B9EGV	5827	BR9EIX	3981	0.5

MALAGUTI									
50	Ciak 50	00→02	BR8HS	4322			BR8HIX	7001	0.6
	Crosser	99→01	BPR6HS	7022			BPR6HIX	4085	0.5
	F-10 Jetline	96→06	BR7HS	4122			BR7HIX	7067	0.5
	F-12 Dragon	96→	BR7HS	4122			BR7HIX	7067	0.5
	F-12 Phantom	96→06	BR7HS	4122			BR7HIX	7067	0.5
	F-15 Firefox	97→	BR8HS	4322			BR8HIX	7001	0.5
	Foggy Replica		BR8HS	4322			BR8HIX	7001	0.5
	RCX10 (50cc Franco Morini)		B7HS	5110			BR7HIX	7067	0.5

2 Wheel



CC	MODEL	DATE	STANDARD COPPER CORE	STOCK NUMBER	PLATINUM OR GOLD PALLADIUM	STOCK NUMBER	IRIDIUM	STOCK NUMBER	GAP MM
MALAGUTI (CONTINUED)									
50	RCX12 (50cc Franco Morini)		B7HS	5110			BR7HIX	7067	0.5
	Wild Attack F12		BR8HS	4322			BR8HIX	7001	0.5
	Yesterday 50	98→00	BR8HS	4322			BR8HIX	7001	0.5
70	F-69 Phantom	97→99	BR7HS	4122			BR7HIX	7067	0.5
100	Ciak 100	00→04	BR8HS	4322			BR8HIX	7001	0.6
	F-12 Phantom 100TD	99→	BR7HS	4122			BR7HIX	7067	0.6
125	Ciak 125	01→04	BR7HS	4122			BR7HIX	7067	0.6
	Madison 125	99→04	CR8E	1275			CR8EIX	4218	0.7
150	F-18 Warrior	01→	DPR7EA-9	5129	DPR7EVX-9	7682	DPR7EIX-9	7803	0.9
250	Madison 250cc	99→04	DPR9EA-9	5329			DPR9EIX-9	5545	0.9
400	Madison K400	02→04	CR9E	6263			CR9EIX	3521	0.7
500	Spidermax 500 GT	04→	CR7EKB	4455			CR7EIX	7385	0.6

MBK									
50	Booster 50 NG	99→02	BR8HS	4322			BR8HIX	7001	0.5
	Flipper 50		BR8HS	4322			BR8HIX	7001	0.5
	Mach-G Air Cooled		BR8HS	4322			BR8HIX	7001	0.6
	Mach-G Liquid Cooled		BR8HS	4322			BR8HIX	7001	0.6
	Nitro 50	99→	BR8HS	4322			BR8HIX	7001	0.5
	Nitro-Jaguar F1		BR8HS	4322			BR8HIX	7001	0.5
	Ovetto 50	99→	BR7HS	4122			BR7HIX	7067	0.6
	Stunt 50	00→	BR9HS	4522					0.6
	X-Limit 50 Supermotard, Enduro	05→	BR9ES	5722			BR9EIX	3981	0.7
	X-Power 50	03→	BR9ES	5722			BR9EIX	3981	0.7
100	Nitro 100	01→	BR8HS	4322			BR8HIX	7001	0.5
	Ovetto 100	01→	BR8HS	4322			BR8HIX	7001	0.6
125	Doodo 125	01→	CR8E	1275			CR8EIX	4218	0.7
	Flame X 125		CR7E	4578			CR7EIX	7385	0.8
	Skycruiser 125	06→	CPR9EA-9	2308					0.9
	Skyliner 125	01→	CR8E	1275			CR8EIX	4218	0.7
	Thunder 125	01→	CR8E	1275			CR8EIX	4218	0.7
260	Kilibre 300	03→	DR8EA	7162	DR8EVX	6354	DR8EIX	6681	0.7

MONTESA									
123	Cota 123		B6ES	7310					0.5
125	MH123 (Honda Engine)		BR7ES	5122			BR7EIX	6664	0.7
175	Cota 172		B6ES	7310					0.5
	Cota 200		B6ES	7310					0.5
200	MH200 (Honda Engine)		BPR7ES	2023			BPR7EIX	4055	0.5
250	310		BPR7ES	2023			BPR7EIX	4055	0.5
	Cota 242		BP6ES	7811	BP6EVX	5832	BPR6EIX	6637	0.5
	Cota 247		B6HS	4510			BR6HIX	3419	0.6
	Cota 248		BP5ES	6511			BPR5EIX	6597	0.5
	Cota 315 (Honda Engine)	97→99	BR6ES	4922					0.6
	Cota 4T (Honda Engine)	05→	CR6EH-9	2688					0.9
260	304, 307, 309		BPR5ES	7422			BPR5EIX	6597	0.5
	311		BPR5ES	7422			BPR5EIX	6597	0.5
	314		BR6ES	4922					0.6
310	348		BPR5ES	7422			BPR5EIX	6597	0.5
330	330		BPR5ES	7422			BPR5EIX	6597	0.5
350	335		BPR5ES	7422			BPR5EIX	6597	0.5
	Cota 349		BP5ES	6511			BPR5EIX	6597	0.5

MOTO GUZZI									
350	V35	84→87	B8ES	2411	B8EVX	7051	BR8EIX	5044	0.5
500	V50	79→86	B8ES	2411	B8EVX	7051	BR8EIX	5044	0.5
650	V65	84→93	B8ES	2411	B8EVX	7051	BR8EIX	5044	0.5
750	Breva 750 i.e.	04→	BR8ES	5422			BR8EIX	5044	0.6
	Nevada 750 NT/Nevada club (with Digiplex)		BR8ES	5422			BR8EIX	5044	0.6
	V7 Classic	07/08→	BR8ES	5422			BR8EIX	5044	0.6
	V7 Café Classic	09→	BR8ES	5422			BR8EIX	5044	0.6
	V75	86→88	B8ES	2411	B8EVX	7051	BR8EIX	5044	0.5



CC	MODEL	DATE	STANDARD COPPER CORE	STOCK NUMBER	PLATINUM OR GOLD PALLADIUM	STOCK NUMBER	IRIDIUM	STOCK NUMBER	GAP MM
MOTO GUZZI (CONTINUED)									
850	Le Mans II & III	78→82	BP6ES	7811	BP6EVX	5832	BPR6EIX	6637	0.7
	Series V850		BP6ES	7811	BP6EVX	5832	BPR6EIX	6637	0.7
940	Bellagio 940 (Twin Spark)	07→	BPR6ES	7822			BPR6EIX	6637	0.7
	(Ø14mm Plug) (Ø10mm Plug)				PMR8B	6378		0.7	
1000	California III I.E.		BP7ES	2412	BP7EVX	7270	BPR7EIX	4055	0.5
	California III with Digiplex		BP7ES	2412	BP7EVX	7270	BPR7EIX	4055	0.5
	Centaurio V10, Centaurio Sport/GT	97→00	DR9EA	3437	DR9EVX	6361	DR9EIX	4772	0.6
	Daytona 1000	92→	D9EA	2420	D9EVX	2834	DR9EIX	4772	0.7
	Daytona 1000 RS 96→	96→00	DR9EA	3437	DR9EVX	6361	DR9EIX	4772	0.6
	Le Mans IV 1000	82→03/85	BP7ES	2412	BP7EVX	7270	BPR7EIX	4055	0.5
	Le Mans V (Le Mans 1000)	85→94	BP7ES	2412	BP7EVX	7270	BPR7EIX	4055	0.5
	Quota 1000	92→	BP7ES	2412	BP7EVX	7270	BPR7EIX	4055	0.5
	Series 1000		BP6ES	7811	BP6EVX	5832	BPR6EIX	6637	0.7
1100	Breva V 1100 (Twin Spark)	05→	BPR6ES	7822			BPR6EIX	6637	0.7
	(Ø14mm Plug) (Ø10mm Plug)				PMR8B	6378		0.7	
	California 1100 Carb 94→	94→96	BPR6ES	7822			BPR6EIX	6637	0.6
	California 1100 Inj 94→(Inc. EV, Jackal, Special, Stone & Touring)	94→	BPR6ES	7822			BPR6EIX	6637	0.7
	California Vintage (Twin Spark)	06→	BPR6ES	7822			BPR6EIX	6637	0.7
	(Ø14mm Plug) (Ø10mm Plug)				PMR8B	6378		0.7	
	Griso 1100 (Twin Spark)	05→	BPR6ES	7822			BPR6EIX	6637	0.7
	(Ø14mm Plug) (Ø10mm Plug)				PMR8B	6378		0.7	
	Quota 1100 ES	98→01	BPR6ES	7822			BPR6EIX	6637	0.5
	Sport 1100 (Carb) 94→08/96	94→08/96	BP6ES	7811	BP6EVX	5832	BPR6EIX	6637	0.6
	Sport 1100 (Injection)	96→99	BPR6ES	7822			BPR6EIX	6637	0.6
V11 (Twin Spark models)	05→	BPR6ES	7822			BPR6EIX	6637	0.7	
(Ø14mm Plug) (Ø10mm Plug)				PMR8B	6378		0.7		
V11 1100cc	01→	BPR6ES	7822			BPR6EIX	6637	0.6	
V11 Le Mans	03→	BPR6ES	7822			BPR6EIX	6637	0.6	
1150	Griso 8V	08→			PMR8B	6378			0.7
	Griso 8V SE	09→			PMR8B	6378			0.7
	Norge 1200 (Twin Spark)	06→	BPR6ES	7822			BPR6EIX	6637	0.7
	(Ø14mm Plug) (Ø10mm Plug)				PMR8B	6378		0.7	
	Sport 1200 (Twin Spark)	07→08	BPR6ES	7822			BPR6EIX	6637	0.7
	(Ø14mm Plug) (Ø10mm Plug)				PMR8B	6378		0.7	
	Sport 1200 V4	09→			PMR8B	6378			0.7
Stelvio 1200 4V	08→			PMR8B	6378			0.7	
Stelvio 1200 TT (NTX)	09→			PMR8B	6378			0.7	
1225	MGS-01 Corsa	05→					DCPR9EIX	2316	0.6

MOTO HISPANIA									
50	Furia 50, Furia Cross (1/2", 12.7mm Thread Reach)		BPR7HS	6422			BPR7HIX	5944	0.6
	Furia 50, Furia Cross (3/4", 19mm Thread Reach)	99→	BR9ES	5722			BR9EIX	3981	0.6
	RX50		BR9ES	5722			BR9EIX	3981	0.6
	RYZ 50 Cross, Supermoto		BR9ES	5722			BR9EIX	3981	0.6
125	RYZ 125 (Yamaha eng.)		CR7HSA	4549			CR7HIX	7544	0.6

MOTO MORINI									
250	250, Sport, Maestro		BP7ES	2412	BP7EVX	7270	BPR7EIX	4055	0.7
350	350 Sport/Strada 3 1/2, Maestro		BP7ES	2412	BP7EVX	7270	BPR7EIX	4055	0.7
	Kangaroo 350		BP7ES	2412	BP7EVX	7270	BPR7EIX	4055	0.7
500	Excaliber 500/501		BP8ES	2912	BP8EVX	2671	BPR8EIX	6684	0.5
	Sahara 500		BP7ES	2412	BP7EVX	7270	BPR7EIX	4055	0.7
998	9 1/2	06→	CR9E	6263			CR9EIX	3521	0.7
1187	Corsaro	06→	CR9E	6263			CR9EIX	3521	0.7

MOTO ROMA									
50	Bee 50		BPR7HS	6422			BPR7HIX	5944	0.6
	GoGo 50	02→	BPR7HS	6422			BPR7HIX	5944	0.6
	Grand Prix 50		BPR7HS	6422			BPR7HIX	5944	0.6
	MRX1		B8HS	5510	B8HVX	2634	BR8HIX	7001	0.6
	MRX2		B8HS	5510	B8HVX	2634	BR8HIX	7001	0.6
	MRX2 Sprint	02→	B7HS	5110			BR7HIX	7067	0.6

2 Wheel



CC	MODEL	DATE	STANDARD COPPER CORE	STOCK NUMBER	PLATINUM OR GOLD PALLADIUM	STOCK NUMBER	IRIDIUM	STOCK NUMBER	GAP MM
MOTO ROMA (CONTINUED)									
50	MRX3	02→	B6HS	4510			BR6HIX	3419	0.6
	MRX3 Sprint	02→	B7HS	5110			BR7HIX	7067	0.6
	MRX4	03→	BR10ES	4832			BR10EIX	6801	0.7
	Roadrunner 50		BP7HS	5111			BPR7HIX	5944	0.6
	RT 50 (2-Stroke)	02→	BPR7HS	6422			BPR7HIX	5944	0.6
	Scrambler 50		BPR7HS	6422			BPR7HIX	5944	0.6
	Stinger, Stinger II		BPR7HS	6422			BPR7HIX	5944	0.6
	Wasp		BPR7HS	6422			BPR7HIX	5944	0.6
Wasp II		BPR7HS	6422			BPR7HIX	5944	0.6	
90	RT 90 4-Stroke	02→	BPR7HS	6422			BPR7HIX	5944	0.6
100	Grand Prix 100		BPR7HS	6422			BPR7HIX	5944	0.6
	Roadrunner 100		BPR7HS	6422			BPR7HIX	5944	0.6
110	GoGo 110	02→	CR7HS	7223			CR7HIX	7544	0.6
125	Grand Prix 125		CR7HS	7223			CR7HIX	7544	0.6
	MRX125	02→	D8EA	2120	D8EVX	2850	DR8EIX	6681	0.6
	MRX125B		CR7HSA	4549			CR7HIX	7544	0.6
	Road Runner 125	02→	C7HSA	4629			CR7HIX	7544	0.6
	SMX125		CR7HSA	4549			CR7HIX	7544	0.6
	Virage 125		D8EA	2120	D8EVX	2850	DR8EIX	6681	0.6

MOTOBECANE									
50	All Models		B5HS	4210					0.4

MS									
50	Sprite		BP6ES	7811	BP6EVX	5832	BPR6EIX	6637	0.7
	Steward		BP6ES	7811	BP6EVX	5832	BPR6EIX	6637	0.7

MV AGUSTA									
750	F4, F4S 1+1, F4 SPR	99→	CR9EKB	2305			CR9EIX	3521	0.7
	F4 Brutale S	02→	CR9EKB	2305			CR9EIX	3521	0.7
	F4 Senna	02→	CR9EKB	2305			CR9EIX	3521	0.7
910	Brutale 910, 910 R, 910 S	05→	CR9EKB	2305			CR9EIX	3521	0.7
1000	F4 1000S	04→	R0045J-10	7400					1.1
1078	Brutale 1078 RR	08→	CR9EB	6955			CR9EIX	3521	0.7
	F4 1078 RR 312	08→	CR9EB	6955			CR9EIX	3521	0.7

MZ									
50	Moskito 50		BR7HS	4122			BR7HIX	7067	0.7
	Moskito SX 50		BR7HS	4122			BR7HIX	7067	0.9
125	ETZ 125	86→99	B8HS	5510	B8HVX	2634	BR8HIX	7001	0.6
	Moskito 125		C7HSA	4629			CR7HIX	7544	0.6
	RT/SX/SM 125		CR8E	1275			CR8EIX	4218	0.7
	Saxon Sportstar 125		B8HS	5510	B8HVX	2634	BR8HIX	7001	0.7
	TS125	76→86	B8HS	5510	B8HVX	2634	BR8HIX	7001	0.6
150	ETZ 150	86→95	B8HS	5510	B8HVX	2634	BR8HIX	7001	0.6
	TS150	75→86	B8HS	5510	B8HVX	2634	BR8HIX	7001	0.6
250	ETZ 250/251	81→97	B8HS	5510	B8HVX	2634	BR8HIX	7001	0.6
	TS250-1	76→83	B8HS	5510	B8HVX	2634	BR8HIX	7001	0.6
300	ETZ 300/301 Series	87→97	B8HS	5510	B8HVX	2634	BR8HIX	7001	0.6
500	MZ500, 500R	92→96	D8EA	2120	D8EVX	2850	DR8EIX	6681	0.7
	Saxon (494cc Rotax Engine) Country/ Silver Star /Tour	93→98	D8EA	2120	D8EVX	2850	DR8EIX	6681	0.7
650	Baghira, Black Panther, Mastiff & Supermoto	98→	DPR8EA-9	4929			DPR8EIX-9	2202	0.9
659	Skorpion 659 (Tour/ Traveller/Sport/ Replica)	94→	DPR8EA-9	4929			DPR8EIX-9	2202	0.9
	Skorpion Cup 659cc		DPR9EA-9	5329			DPR9EIX-9	5545	0.9
1000	1000S, SF, ST	04→	BCPR6ET	2197			BKR6EIX	6418	0.8



CC	MODEL	DATE	STANDARD COPPER CORE	STOCK NUMBER	PLATINUM OR GOLD PALLADIUM	STOCK NUMBER	IRIDIUM	STOCK NUMBER	GAP MM
NEVAL									
650	Dnepr Classic, Roadster, Phoenix, Soviet/Soviet Knight	78→	B7HS	5110			BR7HIX	7067	0.5
	Ural 650cc	85→	B6HS	4510			BR6HIX	3419	0.6

NORTON									
750	Atlas		BP8ES	2912	BP8EVX	2671	BPR8EIX	6684	0.6
	Commando		BP7ES	2412	BP7EVX	7270	BPR7EIX	4055	0.6
850	Commando		BP7ES	2412	BP7EVX	7270	BPR7EIX	4055	0.6
Rotary	F1, Commander	88→93	C8E	7471			CR8EIX	4218	0.6

PEUGEOT									
50	Buxy / Buxy RS 50 (Air Cooled)	95→97	B7HS	5110			BR7HIX	7067	0.6
	Blaster RS12	06→	BR7HS	4122			BR7HIX	7067	0.6
	Elyseo 50 (Air Cooled)	98→	BR7HS	4122			BR7HIX	7067	0.6
	Elystar 50P	02→05	CPR8E	7411					0.8
	Jet Force 50	03→	CPR8E	7411					0.8
	Jet Force C-Tech	06→	CR7EB	4663			CR7EIX	7385	0.6
	Jet Force TSDI	05→	CR7EKA	1462					0.7
	Looxor 50	01→04	BR7HS	4122			BR7HIX	7067	0.6
	Looxor 50 TSDI Inj. 2-Stroke	02→	CPR8E	7411					0.8
	Ludix 50 Blaster, Elegance, Snake	04→	BR7HS	4122			BR7HIX	7067	0.6
	Metal-X	02→	BR7HS	4122			BR7HIX	7067	0.6
	Speedake 50 (Air Cooled)	95→97	BR7HS	4122			BR7HIX	7067	0.6
	Speedfight 50 (All models Air Cooled)	96→00	BR7HS	4122			BR7HIX	7067	0.6
	Speedfight 50 LCD/P (Liquid Cooled)	96→00	BR7HS	4122			BR7HIX	7067	0.6
	Speedfight 2 50 (Air Cooled)	00→	BR7HS	4122			BR7HIX	7067	0.6
	Speedfight 2 50 (Liquid Cooled)	01→	BR7HS	4122			BR7HIX	7067	0.6
	Squab (Air Cooled)	96→97	BR7HS	4122			BR7HIX	7067	0.6
	TKR 50	03→	BR7HS	4122			BR7HIX	7067	0.6
	Trekker (50 Road/Off Road)	97→04	BR7HS	4122			BR7HIX	7067	0.6
	Vivacity 50, Vivacity 50P	99→	BR7HS	4122			BR7HIX	7067	0.6
Vivacity 50 Sportline	00→	BR7HS	4122			BR7HIX	7067	0.6	
V-Clic	07→	CR7HSA	4549			CR7HIX	7544	0.6	
XPS 50 Enduro, Trail, Supermotard 50	03→	BR9ES	5722			BR9EIX	3981	0.7	
XR6 50	03→	BR9ES	5722			BR9EIX	3981	0.7	
Zenith 50 L, M, LS, N	95→00	BR7HS	4122			BR7HIX	7067	0.6	
100	Elyseo 100	98→	BR8ES	5422			BR8EIX	5044	0.6
	Looxor 100	01→04	BR8ES	5422			BR8EIX	5044	0.6
	Metal X 100	02→	BR8ES	5422			BR8EIX	5044	0.6
	Speedfight 100 (Air Cooled)	97→	BR8ES	5422			BR8EIX	5044	0.6
	Speedfight WRC 206 (Air Cooled)	01→	BR8ES	5422			BR8EIX	5044	0.6
	Speedfight 2	00→08	BR8ES	5422			BR8EIX	5044	0.6
	Trekker 100 (Air Cooled)	97→00	BR8ES	5422			BR8EIX	5044	0.6
	Vivacity 100, Vivacity 100 Sportline	99→08	BR8ES	5422			BR8EIX	5044	0.6
125	Elyseo 125 (Liquid Cooled)	99→	CR7E	4578			CR7EIX	7385	0.6
	Elystar 125	02→05	CR7EB	4663			CR7EIX	7385	0.6
	Geopolis Executive 125	07→	CR9EB	6955			CR9EIX	3521	0.6
	Jet Force F.I.	03→	CR7EB	4663			CR7EIX	7385	0.6
	Jet Force EFI Compressor	05→	CR8EK	3478			CR8EIX	4218	0.7
	Looxor 125	02→	CR7EB	4663			CR7EIX	7385	0.6
	Satelis 125	05→	CR9EB	6955			CR9EIX	3521	0.6
	Satelis 125 Compressor	07→	CR9EB	6955			CR9EIX	3521	0.6
	SV125	91→94	BP6HS	4511			BPR6HIX	4085	0.6
	XPS CT125	06→08	CR7HSA	4549			CR7HIX	7544	0.7
150	Elyseo 150 (Liquid Cooled)	00→02	CR7E	4578			CR7EIX	7385	0.6
	Elystar 150	02→	CR7EB	4663			CR7EIX	7385	0.6
	Looxor 150	02→	CR7EB	4663			CR7EIX	7385	0.6
250	Geopolis Executive 250	07→	CR9EB	6955			CR9EIX	3521	0.6

2 Wheel



CC	MODEL	DATE	STANDARD COPPER CORE	STOCK NUMBER	PLATINUM OR GOLD PALLADIUM	STOCK NUMBER	IRIDIUM	STOCK NUMBER	GAP MM
PGO									
50	Big Max, G-Max, Mega, Tornado, Galaxy 50	04→	BPR7HS	6422			BPR7HIX	5944	0.6
	Comet 50, PMX Sport 50, Rodoshow 50, T-Rex 50	98→	BPR7HS	6422			BPR7HIX	5944	0.6
	Libra 50	08→	BPR7HS	6422			BPR7HIX	5944	0.6
	Ligero 50	08→	BPR7HS	6422			BPR7HIX	5944	0.6
	PMX Naked 50	07→	BPR7HS	6422			BPR7HIX	5944	0.6
125	G Max 125	05→	CR7HSA	4549			CR7HIX	7544	0.6
	Libra 125	08→	C7HSA	4629			CR7HIX	7544	0.6
	Ligero 125	08→	C7HSA	4629			CR7HIX	7544	0.6
	T-Rex 125	98→	CR7HSA	4549			CR7HIX	7544	0.6
250	G Max 250	05→07	DPR7EA-9	5129	DPR7EVX-9	7682	DPR7EIX-9	7803	0.7

PIAGGIO / VESPA									
50	50 Special	83→	B6HS	4510			BR6HIX	3419	0.5
	Fly 50 (2-Stroke)	04→	BR9ES	5722			BR9EIX	3981	0.6
	Fly 50 (4-Stroke)	06→	CR8EB	7784			CR8EIX	4218	0.8
	Free 50 (All versions)	93→97	BR9ES	5722			BR9EIX	3981	0.5
	Liberty 50 (2-Stroke)	97→	BR9ES	5722			BR9EIX	3981	0.5
	Liberty 50 (4-Stroke)	02→	CR9EB	6955			CR9EIX	3521	0.7
	NRG 50, NRG Power DD/DT (Ø14mm Plug)	97→	BR9ES	5722			BR9EIX	3981	0.6
	NRG mc3 Pure Jet (Ø10mm Plug)	02→	CPR8E	7411					0.8
	NRG mc3 Pure Jet (Ø10mm Plug)	06→			ZMR7AP	6914			0.8
	PK50S	83→87	B6HS	4510			BR6HIX	3419	0.5
	Sfera 50	91→97	BR9ES	5722			BR9EIX	3981	0.5
	Typhoon 50	93→	B9ES	2611	B9EVX	7254	BR9EIX	3981	0.5
	Velofax, Quartz, Zip, Zip SP (2-Stroke)	93→	BR9ES	5722			BR9EIX	3981	0.5
	Vespa ET2	97→05	BR9ES	5722			BR9EIX	3981	0.5
	Vespa ET4 50 (4-Stroke)	01→05	CR9EB	6955			CR9EIX	3521	0.6
	Vespa LX50 (2-Stroke)		BR9ES	5722			BR9EIX	3981	0.6
	Vespa LX50 (4-Stroke)	06→	CR8EB	7784			CR8EIX	4218	0.8
	Vespa S 50	08→	ER9EH-6N	1673					0.6
	Zip 50 (2-Stroke)	93→	BR9ES	5722			BR9EIX	3981	0.7
	Zip 50 (4-Stroke)	02→	CR9EB	6955			CR9EIX	3521	0.6
80	Sfera 80	93→98	BR9ES	5722			BR9EIX	3981	0.5
	Typhoon 80	94→00	B9ES	2611	B9EVX	7254	BR9EIX	3981	0.5
100	Diesis 100	02→03	BR9ES	5722			BR9EIX	3981	0.6
	PK 100 S	83→93	B6HS	4510			BR6HIX	3419	0.5
	Zip 100 (4-Stroke)	06→08	CR9EB	6955			CR9EIX	3521	0.7
125	Ape		BR7HS	4122			BR7HIX	7067	0.7
	B 125 Beverly (Liquid Cooled 4-Stroke)	02→	CR8EB	7784			CR8EIX	4218	0.8
	Carnaby 125	07→	CR8EB	7784			CR8EIX	4218	0.8
	Cosa, Cosa II (125)	90→95	BR9ES	5722			BR9EIX	3981	0.6
	Fly 125 (4-Stroke)	05→	CR7EB	4663			CR7EIX	7385	0.6
	Hexagon 125	94→98	BR9ES	5722			BR9EIX	3981	0.5
	Hexagon GTX 125	00→02	CR9EB	6955			CR9EIX	3521	0.7
	Hexagon LX 125	98→00	BR9ES	5722			BR9EIX	3981	0.6
	Liberty 125 (4-Stroke)	98→	CR9E	6263			CR9EIX	3521	0.6
	Liberty 125 Leader		CR8EB	7784			CR8EIX	4218	0.7
	MP3 125		CR8EB	7784			CR8EIX	4218	0.8
	P125X		B6HS	4510			BR6HIX	3419	0.5
	Primavera & PK 125		B6HS	4510			BR6HIX	3419	0.5
	Primavera ET3		B7HS	5110			BR7HIX	7067	0.5
	Sfera 125 (4-Stroke)	96→98	CR9E	6263			CR9EIX	3521	0.6
	Skipper 93→98	93→98	B9ES	2611	B9EVX	7254	BR9EIX	3981	0.5
	Skipper 125 (2-Stroke) 98→01	98→01	BR9ES	5722			BR9EIX	3981	0.5
	Skipper ST 125 (4-Stroke)	00→	CR7EB	4663			CR7EIX	7385	0.6
	Typhoon 125	95→03	B9ES	2611	B9EVX	7254	BR9EIX	3981	0.5
	Vespa ET4 125 (4-Stroke)	96→05	CR8EB	7784			CR8EIX	4218	0.8
	Vespa GT 125 Granturismo	03→07	CR8EB	7784			CR8EIX	4218	0.8
	Vespa GT V 125	06→	CR8EB	7784			CR8EIX	4218	0.8
	Vespa LX 125	05→	CR7EB	4663			CR7EIX	7385	0.6
	Vespa LX V 125	06→	CR7EB	4663			CR7EIX	7385	0.6
	Vespa PX125E (Electric Start)	82→93	BR7HS	4122			BR7HIX	7067	0.5
	Vespa PX125T5, T5 Classic		B9ES	2611	B9EVX	7254	BR9EIX	3981	0.5



CC	MODEL	DATE	STANDARD COPPER CORE	STOCK NUMBER	PLATINUM OR GOLD PALLADIUM	STOCK NUMBER	IRIDIUM	STOCK NUMBER	GAP MM
PIAGGIO / VESPA (CONTINUED)									
125	X8 125	06→08	CR8EB	7784			CR8EIX	4218	0.6
	X9 125 (Piaggio 4-Stroke)	01→	CR8EB	7784			CR8EIX	4218	0.6
	Xevo 125	07→	CR8EB	7784			CR8EIX	4218	0.7
	Zip 125	01→04	CR7EB	4663			CR7EIX	7385	0.6
150	Cosa 150		BR9ES	5722			BR9EIX	3981	0.6
	Vespa PX150	83→90	B6HS	4510			BR6HIX	3419	0.5
180	Hexagon 180LXT	98→00	BR9ES	5722			BR9EIX	3981	0.6
190	Ape		BR7HS	4122			BR7HIX	7067	0.7
200	Beverly 200 (4-Stroke)		CR8EB	7784			CR8EIX	4218	0.8
	Cosa 200, P200E		B6ES	7310					0.5
	Cosa II 200	88→91	B7ES	1111			BR7EIX	6664	0.5
	Vespa GT 200 Granturismo	03→07	CR7EB	4663			CR7EIX	7385	0.6
	Vespa PX200	86→	B7ES	1111			BR7EIX	6664	0.5
	Vespa PX200 E Disc 1998→	98→	BR6ES	4922					0.6
	X8 200	05→	CR7EKB	4455			CR7EIX	7385	0.6
220	Ape		BR7HS	4122			BR7HIX	7067	0.7
250	Hexagon GT 250, GTX 250 (Honda 4-Stroke)	98→01	DPR6EA-9	5531					0.9
	Super Hexagon GTX250	00→	CR9E	6263			CR9EIX	3521	0.7
	Vespa GTS 250i.e.	05→	CR8EB	7784			CR8EIX	4218	0.6
	X8 250	06→08	CR8EB	7784			CR8EIX	4218	0.6
	X9 250cc (Honda 4-Stroke)	00→	DPR7EA-9	5129	DPR7EVX-9	7682	DPR7EIX-9	7803	0.9
	X9 250cc Evolution (Quasar 4-Stroke + carb)		CR8EB	7784			CR8EIX	4218	0.6
300	Vespa GTS 300	08→	CR8EKB	4374			CR8EIX	4218	0.7
400	X8 400	06→08	CR7EKB	4455			CR7EIX	7385	0.7
460	B500	03→	CR7EKB	4455			CR7EIX	7385	0.7
	X9 500 (Fuel Injection 4-Stroke)	02→	CR7EKB	4455			CR7EIX	7385	0.7
	X9 500 Evolution (Fuel Injection 4-Stroke)	04→08	CR7EKB	4455			CR7EIX	7385	0.7

PUCH									
50	Magnum		B-4H	4110					0.5
	Maxi: 1.0 HP Models		B-4H	4110					0.5
	Maxi: 1.5 HP Models		B5HS	4210					0.5
	Maxi: 2.0 HP Models		B6HS	4510			BR6HIX	3419	0.5
	Monza 50, Ranger 50, X40		B7HS	5110			BR7HIX	7067	0.5

REGAL RAPTOR									
50	DD50QE-2	03→	CR7HS	7223			CR7HIX	7544	0.7
100	DD100E	03→	CR7HS	7223			CR7HIX	7544	0.7

REGENT									
125	Roadster, Deluxe, Sports Tourer, Super RT125		B7HS	5110			BR7HIX	7067	0.6
150	Roadster, Trail, Deluxe	95→97	B7HS	5110			BR7HIX	7067	0.6
175	Roadster, Trail, Deluxe, Sports Tourer, Super RT175	95→97	B7HS	5110			BR7HIX	7067	0.6

RIEJU									
50	MRX 50 (Minarelli Engine)	03→	BR9ES	5722			BR9EIX	3981	0.8
	MRX 50 Pro	03→	BR9ES	5722			BR9EIX	3981	0.8
	MX50 (Morini S5 Engine)	03→	B6HS	4510			BR6HIX	3419	0.5
	RR50 / Spike / Supermotard / RR50 Castrol	97→	BR9ES	5722			BR9EIX	3981	0.8
	RRX Spike 50 Supermoto	07→	BR8ES	5422			BR8EIX	5044	0.5
	RS1 Evolution	98→04	BR9ES	5722			BR9EIX	3981	0.8
	RS2 50 Matrix	03→	BR9ES	5722			BR9EIX	3981	0.8
	SMX (Minarelli Engine)	03→	BR9ES	5722			BR9EIX	3981	0.8
125	MRX (Yamaha 4-Stroke)	03→	CR7HSA	4549			CR7HIX	7544	0.6
	SMX (Yamaha 4-Stroke)	03→	CR7HSA	4549			CR7HIX	7544	0.6

ROVIGO									
50	Spoletto 50, Tempesta 50	99→	BPR7HS	6422			BPR7HIX	5944	0.6

2 Wheel



CC	MODEL	DATE	STANDARD COPPER CORE	STOCK NUMBER	PLATINUM OR GOLD PALLADIUM	STOCK NUMBER	IRIDIUM	STOCK NUMBER	GAP MM
ROYAL ENFIELD (1980→)									
350	Bullet Classic Models	80→	B7HS	5110			BR7HIX	7067	0.5
500	Bullet Classic Models	80→08	BR8ES	5422			BR8EIX	5044	0.5
	Bullet Electra X Lean Burn Engine Models	04→08	BR9ES	5722			BR9EIX	3981	0.8

RTX									
125	Cross C125, Trials T125		B7HS	5110			BR7HIX	7067	0.6
212	Cross C212, Trials T212		B8HS	5510	B8HVX	2634	BR8HIX	7001	0.6

SACHS									
50	Dirty Devil	04→	BP5HS	4111					0.6
	MadAss 50	04→	CR7HSA	4549			CR7HIX	7544	0.6
110	Dirty Devil	04→	C7HSA	4629			CR7HIX	7544	0.6
125	MadAss 125	06→	C7HSA	4629			CR7HIX	7544	0.6
	Roadster 125	00→05	CR6HSA	2983			CR6HIX	7274	0.8
	XTC 125, ZX Enduro 125, ZZ 125	00→	BR9ES	5722			BR9EIX	3981	0.8
650	Roadster 650	00→	CR10E	6264			CR10EIX	6482	0.8
805	B 805	02→	DPR8EA-9	4929			DPR8EIX-9	2202	0.9
	Roadster 800	00→05	DPR8EA-9	4929			DPR8EIX-9	2202	0.9

SCORPA									
70	4-Tricks	06→07	CR7HSA	4549			CR7HIX	7544	0.7
125	SY 125 F	03→	CR7HSA	4549			CR7HIX	7544	0.7
	TY-S 125F	04→06	CR7HSA	4549			CR7HIX	7544	0.7
175	SY 175 F	03→	CR7HSA	4549			CR7HIX	7544	0.7
	TY-S 175 F	03→	CR7HSA	4549			CR7HIX	7544	0.7
250	SY 250						BPR6EIX	6637	0.7
	SY 250 FR	06→	CR8E	1275			CR8EIX	4218	0.7
	SY 250 Long Ride	06→			BKR5EVX	2546	BKR5EIX	6341	0.6
	SY 250 Racing	01→			BKR5EVX	2546	BKR5EIX	6341	0.6
	T-Ride 250F	08→	CR8E	1275			CR8EIX	4218	0.7
	TY 250 / E					BKR6EVX	3539	BKR6EIX	6418
300	294, 295		BP5ES	6511			BPR5EIX	6597	0.5

SHERCO									
50	0.5 Kid	03→	B9ES	2611	B9EVX	7254	BR9EIX	3981	0.6
	Enduro 50	03→	BR9ES	5722			BR9EIX	3981	0.7
	HRD50	03→	BR9ES	5722			BR9EIX	3981	0.7
	Supermotard 50	03→	BR9ES	5722			BR9EIX	3981	0.7
80	0.8		BP5ES	6511			BPR5EIX	6597	0.5
125	1.25	99→	BP5ES	6511			BPR5EIX	6597	0.6
	City Corp 125	04→	CR7HSA	4549			CR7HIX	7544	0.6
200	2.0	99→	BP5ES	6511			BPR5EIX	6597	0.6
250	2.5	99→	BP5ES	6511			BPR5EIX	6597	0.6
290	2.9	99→	BP5ES	6511			BPR5EIX	6597	0.6
320	3.2 4T	05→			PFR6B	3500			0.6
450	4.5 4T	04→	CR8EK	3478			CR8EIX	4218	0.7
	4.5i Enduro	05→	CR8EK	3478			CR8EIX	4218	0.7

SIMSON									
50	S51 Series SR50		B7HS	5110			BR7HIX	7067	0.5
70	S70 C&E	83→	B7HS	5110			BR7HIX	7067	0.5

SINNIS									
50	Eagle, Ghost, Hawk, Nitro, Pioneer, Strike (2-Stroke)	06/06→	BPR7HS	6422			BPR7HIX	5944	0.6
	Falcon, Jet (4-Stroke)	06/06→	CR7HSA	4549			CR7HIX	7544	0.6
110	Breeze	06/06→	CR7HSA	4549			CR7HIX	7544	0.6
125	Apache, Blade, Max, Stealth, Vista	12/07→	CR8E	1275			CR8EIX	4218	0.7
	Eagle, Matrix, Matrix II, Nitro, Pioneer, Sublime (4-Stroke)	01/07→	CR7HSA	4549			CR7HIX	7544	0.6
200	Apache, Blade	12/07→	DR8ES-L	2923	DR8EVX	6354	DR8EIX	6681	0.7



CC	MODEL	DATE	STANDARD COPPER CORE	STOCK NUMBER	PLATINUM OR GOLD PALLADIUM	STOCK NUMBER	IRIDIUM	STOCK NUMBER	GAP MM
SMC									
50	NAF 50 Navigator		BPR7HS	6422			BPR7HIX	5944	0.6
	NGF 50 Sports Force		BPR7HS	6422			BPR7HIX	5944	0.6
	NKF 50 on/off road		BPR7HS	6422			BPR7HIX	5944	0.6
	NLFR 50 Caprillio		BPR7HS	6422			BPR7HIX	5944	0.6
	PAF 50 Partner		BPR7HS	6422			BPR7HIX	5944	0.6
	SBF 50 Super		BPR7HS	6422			BPR7HIX	5944	0.6
90	NGN 90 Sports Force		BPR7HS	6422			BPR7HIX	5944	0.6
	SBN 90 Super		BPR7HS	6422			BPR7HIX	5944	0.6
100	NKO 100 on/off road		BPR7HS	6422			BPR7HIX	5944	0.6
	SBO 100 Super		BPR7HS	6422			BPR7HIX	5944	0.6
125	CHP 125 Chopper		DR8EA	7162	DR8EVX	6354	DR8EIX	6681	0.7

SUZUKI									
50	AE50 L/M/N/P/R/T	90→99	BPR6HS	7022			BPR6HIX	4085	0.6
	AH50	93→96	BPR6HS	7022			BPR6HIX	4085	0.6
	AP50T/V/W	96→02	BPR6HS	7022			BPR6HIX	4085	0.7
	AY50 Katana/Sport W/Y/WRX/WRY/WR K1-K4		BPR6HS	7022			BPR6HIX	4085	0.8
	AY50-W K4		BPR6HS	7022			BPR6HIX	4085	0.8
	AY50A K5	05→	CPR8E	7411					0.8
	CL50D,CS50D,FS50 Snip		BPR4HS	7823					0.7
	CP50	85→92	BPR6HS	7022			BPR6HIX	4085	0.6
	DR50		BR7HS	4122			BR7HIX	7067	0.6
	FR50	81→86	BPR4HS	7823					0.7
	FZ50 Suzy	80→86	BPR4HS	7823					0.7
	JR50 K4		BPR4HS	7823					0.7
	RM50-C/N/T/X/Z		B7HS	5110			BR7HIX	7067	0.6
	RMX 50		BPR8ES	3923					0.7
	SMX 50		BPR8ES	3923					0.7
	TR50S	97→00	BPR6HS	7022			BPR6HIX	4085	0.6
	TS50 X/ER/XKE-G-H-J-M-R	84→	BPR6ES	7822			BPR6EIX	6637	0.7
	TS50 /ER/K/N		BP6HS	4511			BPR6HIX	4085	0.7
	UF 50 Estilete	99→01	BPR7HS	6422			BPR7HIX	5944	0.6
	UX50W-X-Y Zillion	99→01	BPR6HS	7022			BPR6HIX	4085	0.6
ZR50-L/X1/SKE	83→	BP6ES	7811	BP6EVX	5832	BPR6EIX	6637	0.7	
65	RM65 K3-K5		B10EG	3630	B10EGV	5927	BR10EIX	6801	0.6
70	DR-Z70	08→	CR7HSA	4549			CR7HIX	7544	0.6
80	CP80	85→94	BPR6HS	7022			BPR6HIX	4085	0.7
	CS80CD	83→87	BPR6HS	7022			BPR6HIX	4085	0.7
	FR80D	84→87	BPR6HS	7022			BPR6HIX	4085	0.7
	RM80T		B10EG	3630	B10EGV	5927	BR10EIX	6801	0.6
	RM80X G/H/J/K/L		B9EG	3530	B9EGV	5827	BR9EIX	3981	0.7
	RM80X M/N/P/R/S/T/V		B10EG	3630	B10EGV	5927	BR10EIX	6801	0.7
RM80 K1	00→	BR10ES	4832			BR10EIX	6801	0.8	
85	RM85 /L K3-K4-K5	03→	BR10ES	4832			BR10EIX	6801	0.8
100	AH100	94→97	BPR7HS	6422			BPR7HIX	5944	0.6
	GP100 All models	78→92	B8HS	5510	B8HVX	2634	BR8HIX	7001	0.7
	RM100 K4	04→	R6252K-105	2741					0.7
	TS100ER, TS100ERZ	78→89	B8ES	2411	B8EVX	7051	BR8EIX	5044	0.7
110	UG 110 Hokuto	99→02	BPR7HS	6422			BPR7HIX	5944	0.6
125	Address 125	07→	CR8E	1275			CR8EIX	4218	0.7
	AN125 S	95→96	CR8E	1275			CR8EIX	4218	0.6
	AN125 T,V,W	96→11/98	CR7E	4578			CR7EIX	7385	0.6
	AN125 X	11/98→	CR8E	1275			CR8EIX	4218	0.7
	CS125D	83→87	D8EA	2120	D8EVX	2850	DR8EIX	6681	0.7
	DR125 SEX-SEY	99→01	DR8EA	7162	DR8EVX	6354	DR8EIX	6681	0.7
	DR125S,Z/D/F/H/J	82→94	DR8ES-L	2923	DR8EVX	6354	DR8EIX	6681	0.7
	DR125SM	08→	CR8E	1275			CR8EIX	4218	0.7
	GN125 W-X	93→01	DR8EA	7162	DR8EVX	6354	DR8EIX	6681	0.7
	GP125 All models	78→89	B8HS	5510	B8HVX	2634	BR8HIX	7001	0.7
	GS125ES, D All models		DR8ES-L	2923	DR8EVX	6354	DR8EIX	6681	0.7
	GT125		B8HS	5510	B8HVX	2634	BR8HIX	7001	0.7
	GZ125W/X/Y/K1-K3 Marauder	98→	DR8EA	7162	DR8EVX	6354	DR8EIX	6681	0.6
	GZ125 K4-K5	04→	CR8E	1275			CR8EIX	4218	0.7

2 Wheel



CC	MODEL	DATE	STANDARD COPPER CORE	STOCK NUMBER	PLATINUM OR GOLD PALLADIUM	STOCK NUMBER	IRIDIUM	STOCK NUMBER	GAP MM	
SUZUKI (CONTINUED)										
125	RG125 UC, G/H/J/J2	85→94	BR8ES	5422			BR8EIX	5044	0.6	
	RG125FU-N/P/R	91→95	BR9ECM	3252	BR9ECMVX	2434			0.7	
	RG125U Wolf	91→95	BR9ECM	3252	BR9ECMVX	2434			0.6	
	RM125 K/L/M		B9EG	3530	B9EGV	5827	BR9EIX	3981	0.5	
	RM125 E/F/G/H/J		BR9EG	3230			BR9EIX	3981	0.5	
	RM125 N/R/S				R4118S-9	3245			0.6	
	RM125 T/V/W/K1-K7				R6918B-8	4492			0.6	
	RV125 Van Van K4-K5	03→	CR8E	1275			CR8EIX	4218	0.7	
	TS125 (A/B)		B8HS	5510	B8HVX	2634	BR8HIX	7001	0.7	
	TS125 (C,ER/X/Z/D/XUE/XE)		B8ES	2411	B8EVX	7051	BR8EIX	5044	0.7	
	TS125R K/L/M/N/P/R	90→96	BR9ES	5722			BR9EIX	3981	0.7	
	UC125 X Epicuro	99→02	CR8E	1275			CR8EIX	4218	0.7	
	UH125 K2-K9 Burgman	02→	CR8E	1275			CR8EIX	4218	0.7	
	UX125 Sixteen 125	07→	CR8E	1275			CR8EIX	4218	0.7	
VL125 Y/K1-K5 Intruder	99→08	CR8E	1275			CR8EIX	4218	0.7		
200	AN200 K7 Burgman	07→	CR8EK	3478			CR8EIX	4218	0.7	
	DR200S		DR8ES-L	2923	DR8EVX	6354	DR8EIX	6681	0.6	
	GT200X5		B8ES	2411	B8EVX	7051	BR8EIX	5044	0.7	
	SB200	79→83	B8ES	2411	B8EVX	7051	BR8EIX	5044	0.7	
250	AN250 W/X/Y/K1-K3 Burgman	→03	CR8EK	3478			CR8EIX	4218	0.7	
	AN250 K4-K5 Burgman	04→	CR7EK	7546			CR7EIX	7385	0.7	
	GN250, F/J/K/L/M/N/P/R/T	87→97	DR8EA	7162	DR8EVX	6354	DR8EIX	6681	0.6	
	GS250T, T/X	80→84	DR8ES	5423	DR9EVX	6361	DR9EIX	4772	0.7	
	GSX250E T/X/Z	80→85	DR8ES	5423	DR9EVX	6361	DR9EIX	4772	0.7	
	GT250A/B/C (1/2", 12.7mm Thread Reach)		B8HS	5510	B8HVX	2634	BR8HIX	7001	0.7	
	GT250A/B/C (3/4", 19mm Thread Reach)		B9ES	2611	B9EVX	7254	BR9EIX	3981	0.7	
	GT250K/L/M		B8ES	2411	B8EVX	7051	BR8EIX	5044	0.7	
	GT250X7 EN/EX	78→83	B9ES	2611	B9EVX	7254	BR9EIX	3981	0.7	
	PE250 B/C		B8EG	3430	B8EGV	5627	BR8EIX	5044	0.5	
	PE250 N/T/X/Z		BR10EG	3830			BR10EIX	6801	0.6	
	RG250FG/FCH	85→89	B9ES	2611	B9EVX	7254	BR9EIX	3981	0.6	
	RG250WD/WE	83→85	BR9ES	5722			BR9EIX	3981	0.7	
	RGV250K/L	89→90	BR9ES	5722			BR9EIX	3981	0.7	
	RGV250M/N/P/R	90→97	BR9ECM	3252	BR9ECMVX	2434			0.6	
	RM250 E/F/G/H/J/K/L/M		B8EG	3430	B8EGV	5627	BR8EIX	5044	0.5	
	RM250 N/P/R/S	92→95			R4118S-8	3236			0.6	
	RM250T/V/W	96→99			R6918B-7	6259			0.6	
	RM250 K1-K5	01→05	BR8EG	3130			BR8EIX	5044	0.6	
	RM250Z/D		B8EG	3430	B8EGV	5627	BR8EIX	5044	0.5	
	RMX250K/L/M/N/S	89→95			B8EGV	5627	BR8EIX	5044	0.5	
	RMX250RP						BR9EIX	3981	0.5	
	RMX250T						BR9EIX	3981	0.5	
	RM-Z250 K4-K5 (4-Stroke)	04→06	CR8EB	7784			CR8EIX	4218	0.7	
	RM-Z250 K7 (4-Stroke)	07→					CR8EIA-10	4708	1.0	
	TS250 X	85→89	BR8ES	5422			BR8EIX	5044	0.6	
	TS250ER N/T/X	79→83	BP7ES	2412	BP7EVX	7270	BPR7EIX	4055	0.7	
	TU250 X-V-W	97→00	DR8EA	7162	DR8EVX	6354	DR8EIX	6681	0.6	
	350	DR350S-L-M-N-P	91→	DPR9EA-9	5329			DPR9EIX-9	5545	0.9
		DR350SE-S-V-W-X	95→99	CR9EK	4548			CR9EIX	3521	0.6
		DR350-S-R	94→	CR9EK	4548			CR9EIX	3521	0.6
400	AN400 K7-K8 Burgman	10/07→	CR7E	4578			CR7EIX	7385	0.7	
	AN400 X/Y/K1-K6 Burgman	99→	CR7E	4578			CR7EIX	7385	0.7	
	DR400	80→82	DR8ES-L	2923	DR8EVX	6354	DR8EIX	6681	0.7	
	DR-Z400S Y/K1-K5, DR-Z400/E Y/K1-K5	99→07	CR8E	1275			CR8EIX	4218	0.7	
	DR-Z400SM K5-K7	05→07	CR8E	1275			CR8EIX	4218	0.7	
	GN400T	80→82	DR8ES-L	2923	DR8EVX	6354	DR8EIX	6681	0.7	
	GS400, B/C		B8ES	2411	B8EVX	7051	BR8EIX	5044	0.7	
	GSF400M/N	91→	CR8EK	3478			CR8EIX	4218	0.7	
	GSF400P-R	93→95	CR9EK	4548			CR9EIX	3521	0.6	
	GSX400E T/X, GSX400F, X/Z/D	80→	DR8ES-L	2923	DR8EVX	6354	DR8EIX	6681	0.7	
	GSX-R400H	86→	C8HSA	6821	CR8HVX	7236	CR8HIX	7669	0.6	
	PE400T/X/Z		BR9EG	3230			BR9EIX	3981	0.7	
	SP400	80→82	DR8ES-L	2923	DR8EVX	6354	DR8EIX	6681	0.7	



CC	MODEL	DATE	STANDARD COPPER CORE	STOCK NUMBER	PLATINUM OR GOLD PALLADIUM	STOCK NUMBER	IRIDIUM	STOCK NUMBER	GAP MM
SUZUKI (CONTINUED)									
450	GS450	85→	B8ES	2411	B8EVX	7051	BR8EIX	5044	0.7
	RM-Z450 K4-K6 (4-Stroke)	04→06					CR8EIB-10	4948	1.0
	RM-Z450/Z K7-K8 (4-Stroke)	07→					DIMR8B10	5066	1.0
500	GS500E/K/L/M/N/P/R/S/T/V/W/X/Y/K1-K5	89→05	DPR8EA-9	4929			DPR8EIX-9	2202	0.9
	RG500 Gamma	85→89	BR9ES	5722			BR9EIX	3981	0.6
	RM500D		B8EG	3430	B8EGV	5627	BR8EIX	5044	0.6
550	GS550 All models	77→85	B8ES	2411	B8EVX	7051	BR8EIX	5044	0.7
	GSX550 EE/ESD/ESE/EFE	83→88	DR8ES	5423	DR9EVX	6361	DR9EIX	4772	0.7
600	GSF600 S/T/V/W/Y/K1-K4 Bandit Naked (Unfaired)	95→05	CR9EK	4548			CR9EIX	3521	0.6
	GSF600S T/SV/SW/SY/K1-K4 Bandit (Faired)	95→05	CR9EK	4548			CR9EIX	3521	0.6
	GSR600/S K6-K9	06→	CR9E	6263			CR9EIX	3521	0.7
	GSX600F J/K/L/M/N/P/R/S/V	88→97	DR8ES	5423	DR9EVX	6361	DR9EIX	4772	0.7
	GSX600F T-V-W-X-Y-K1-K4	97→04	CR9EK	4548			CR9EIX	3521	0.6
	GSX-R600 V/W/X/K1-K7	97→07	CR9E	6263			CR9EIX	3521	0.6
	GSX-R600 K8-K9	08→					CR9EIA-9	6289	0.9
	RF600R P/R/S/V	93→97	CR9E	6263			CR9EIX	3521	0.7
	VS600 GLS	95→97	DPR8EA-9	4929			DPR8EIX-9	2202	0.9
650	AN650 K3-K5 Burgmann		CR8E	1275			CR8EIX	4218	0.7
	AN650A K4-K9 Burgmann	04→	CR8E	1275			CR8EIX	4218	0.7
	DL650 K4-K5 V-Strom	03→	CR8E	1275			CR8EIX	4218	0.7
	DR650RSE Models and RE models	91→95	DPR9EA-9	5329			DPR9EIX-9	5545	0.9
	DR650SET	95→97	CR10E	6264			CR10EIX	6482	0.7
	GS650 All models (Including Katana)	81→	DR8ES-L	2923	DR8EVX	6354	DR8EIX	6681	0.7
	GSF650 K5 Bandit	05→	CR8EK	3478			CR8EIX	4218	0.7
	GSF650 K7 Bandit Liquid Cooled	08→	CR9E	6263			CR9EIX	3521	0.6
	GSX650F	08→	CR8E	1275			CR8EIX	4218	0.7
	LS650 All models	87→98	DPR8EA-9	4929			DPR8EIX-9	2202	0.9
	SFV650 Gladius	09→					CR8EIA-9	4286	0.9
	SV650, SV650S X/Y/K1-K8	99→08	CR8E	1275			CR8EIX	4218	0.7
XF650 V-W-X-Y Freewind	97→02	CR10E	6264			CR10EIX	6482	0.7	
670	XN85 650 Turbo	83→86	DR8ES	5423	DR9EVX	6361	DR9EIX	4772	0.7
750	DR750 SJ/SK	88→90	DPR9EA-9	5329			DPR9EIX-9	5545	0.9
	GSX750-W/X/Y/K1	97→	CR9EK	4548			CR9EIX	3521	0.6
	GSX750E T/EX/ESD/ESE/ESF/ESG	83→89	DR8ES-L	2923	DR8EVX	6354	DR8EIX	6681	0.7
	GSX750F K/L/M/N/P/R/S/T	89→96	JR9C	6193					0.6
	GSX750F W/X/Y/K1-K5	97→05	CR9EK	4548			CR9EIX	3521	0.6
	GSX-R750 F/G/H	85→88	DR8ES	5423	DR9EVX	6361	DR9EIX	4772	0.7
	GSX-R750 J/K	88→89	JR9C	6193					0.6
	GSX-R750 L/M	89→92	CR10EK	2360			CR10EIX	6482	0.6
	GSX-R750 WN/WP/WR/WS	91→96	CR9E	6263			CR9EIX	3521	0.7
	GSX-R750 T/V/W/X/Y/K1-K7	96→07	CR9E	6263			CR9EIX	3521	0.7
	GSX-R750 K8-K9	08→					CR9EIA-9	6289	0.9
VS750GLP F/G/H/J/K/L/M	85→91	DPR8EA-9	4929			DPR8EIX-9	2202	0.9	
800	C800 Intruder	06→	DPR7EA-9	5129	DPR7EVX-9	7682	DPR7EIX-9	7803	0.9
	DR800 SL/SM	90→92	DPR9EA-9	5329			DPR9EIX-9	5545	0.9
	VL800 K1-K5	01→	DPR7EA-9	5129	DPR7EVX-9	7682	DPR7EIX-9	7803	0.9
	VS800GL M/P/R/S/T/V	91→97	DPR8EA-9	4929			DPR8EIX-9	2202	0.9
	VX800 L/M/R	90→96	DPR8EA-9	4929			DPR8EIX-9	2202	0.9
	VZ800 V/W/X/Y-K1 Marauder	97→01	DPR8EA-9	4929			DPR8EIX-9	2202	0.9
	VZ800 K5 (M800) Intruder	05→	DPR7EA-9	5129	DPR7EVX-9	7682	DPR7EIX-9	7803	0.9
850	GS850 GN/GT/GX/GZ/GD/GE/GG	79→88	B8ES	2411	B8EVX	7051	BR8EIX	5044	0.7
900	RF900R R/S/T/V/W	94→99	CR9E	6263			CR9EIX	3521	0.7
1000	DL1000 K2-K4 V-Strom	02→	CR8EK	3478			CR8EIX	4218	0.7
	GS1000 EC/EN/ET/GT/GX/SN	80→	B8ES	2411	B8EVX	7051	BR8EIX	5044	0.7
	GSX1000 SZ/SD	81→85	DR8ES-L	2923	DR8EVX	6354	DR8EIX	6681	0.7
	GSX-R1000 K1-K6	00→06	CR9E	6263			CR9EIX	3521	0.7
	GSX-R1000 K6 Phantom	06→	CR9E	6263			CR9EIX	3521	0.7
	GSX-R1000 K7-K9	07→					CR9EIA-9	6289	0.9
	SV1000/S K3-K5	03→05	CR8EK	3478			CR8EIX	4218	0.7
	SV1000 Classic	07→08	CR8EK	3478			CR8EIX	4218	0.7
	TL1000R W/Y/K1-K3	98→03	CR9EK	4548			CR9EIX	3521	0.6
TL1000S V/W/X/Y	97→01	CR8EK	3478			CR8EIX	4218	0.7	
1100	GS1100GZ		B8ES	2411	B8EVX	7051	BR8EIX	5044	0.7
	GSX1100 ET/X/Z/S/ESD,SZ ,SD (Katana)	79→85	DR8ES-L	2923	DR8EVX	6354	DR8EIX	6681	0.7

2 Wheel



CC	MODEL	DATE	STANDARD COPPER CORE	STOCK NUMBER	PLATINUM OR GOLD PALLADIUM	STOCK NUMBER	IRIDIUM	STOCK NUMBER	GAP MM
SUZUKI (CONTINUED)									
1100	GSX1100 EFE/EF/EFF/EG/EFG	84→88	DR8ES	5423	DR9EVX	6361	DR9EIX	4772	0.7
	GSX1100 FJ/FK/FL/FM/FN/FP/FR/FS	87→96	JR9B	3188	DR9EVX	6361	DR9EIX	4772	0.6
	GSX1100 GM/GN/GP/GR	91→94	JR9B	3188	DR9EVX	6361	DR9EIX	4772	0.6
	GSX-R1100 G/H/J	86→89	JR9B	3188	DR9EVX	6361	DR9EIX	4772	0.6
	GSX-R1100 K/L/M/N	89→93	JR9B	3188	DR9EVX	6361	DR9EIX	4772	0.6
	GSX-R1100 W-P/R/S/T	93→96	CR9E	6263			CR9EIX	3521	0.7
1200	GSF1200S T/V/W/X/Y/K1-K6 Bandit (Faired)	96→	JR9B	3188	DR9EVX	6361	DR9EIX	4772	0.6
	GSF1200 T/V/W/X/Y/K1-K6 Bandit Naked (Unfaired)	96→	JR9B	3188	DR9EVX	6361	DR9EIX	4772	0.6
1250	GSF1250/SA K7 Bandit	07→	CR7E	4578			CR7EIX	7385	0.8
1300	GSX1300 B-King	07→					CR9EIA-9	6289	0.9
	GSX1300R X/Y/K1-K5 Hayabusa	99→07	CR9E	6263			CR9EIX	3521	0.7
1340	GSX1300R Hayabusa	08→					CR9EIA-9	6289	0.9
1400	GSX1400 K2-K4	01→	CR8EK	3478			CR8EIX	4218	0.7
	VS1400GLP-H-J-R-S-T-V-W (Intruder)	87→99	DPR8EA-9	4929			DPR8EIX-9	2202	0.9
1500	VL1500 LC/X	98→03	DPR7EA-9	5129	DPR7EVX-9	7682	DPR7EIX-9	7803	0.9
	VL1500 →K5	→05	DPR7EA-9	5129	DPR7EVX-9	7682	DPR7EIX-9	7803	0.9
1600	VZ1600 K4-K5	03→04	DPR6EA-9	5531					0.9
1800	VZR1800 K6 (M1800R Intruder)	06→	CR8EK	3478			CR8EIX	4218	0.7
	VZR1800 C1800R/RT Intruder	08→	CR8EK	3478			CR8EIX	4218	0.7

SWM									
125	125TLM		BP5ES	6511			BPR5EIX	6597	0.4
200	TL200		BP5ES	6511			BPR5EIX	6597	0.4
240	TL240		BP5ES	6511			BPR5EIX	6597	0.4
320	320TLM		BP5ES	6511			BPR5EIX	6597	0.4
350	TL350		BP5ES	6511			BPR5EIX	6597	0.4

SYM									
50	City Hopper	98→03	BR8HSA	5539			BPR8HIX	6742	0.6
	DD50 City Trek / Sport	02→	BR8HSA	5539			BPR8HIX	6742	0.6
	Fiddle	98→	BR8HSA	5539			BPR8HIX	6742	0.6
	Fiddle II 50	08→	BR8HSA	5539			BPR8HIX	6742	0.7
	Jet 50	98→	BR8HSA	5539			BPR8HIX	6742	0.6
	Jet 50 Sport X S/SE/SR/XS	06→	BR8HSA	5539			BPR8HIX	6742	0.7
	Jungle	98→02	BR8HSA	5539			BPR8HIX	6742	0.6
	Mask	98→	BR8HSA	5539			BPR8HIX	6742	0.6
	Mio 50	06→	CR6HSA	2983			CR6HIX	7274	0.7
	Red Devil	98→	BR8HSA	5539			BPR8HIX	6742	0.6
	Simply 50	08→	CR7HSA	4549			CR7HIX	7544	0.7
	Super Fancy	98→03	BR8HSA	5539			BPR8HIX	6742	0.6
100	Jet 100	99→	BR8HSA	5539			BPR8HIX	6742	0.6
	Jet 100 Sport X S/SR Jet		BR8HSA	5539			BPR8HIX	6742	0.6
	Mio 100		CR6HSA	2983			CR6HIX	7274	0.7
125	Attila, Super Duke	98→00	CR7HSA	4549			CR7HIX	7544	0.6
	Euro MX 125	05→	CR8E	1275			CR8EIX	4218	0.7
	Fiddle II 125	08→	CR7HSA	4549			CR7HIX	7544	0.6
	GTS Voyager 125	05→	CR8E	1275			CR8EIX	4218	0.8
	HD Orbit 125	04→	CR8E	1275			CR8EIX	4218	0.7
	Husky	98→	DR8EA	7162	DR8EVX	6354	DR8EIX	6681	0.6
	Joyride 125 (12.7mm Thread Reach)	02→04	CR7HSA	4549			CR7HIX	7544	0.6
	Joyride 125 (19mm Thread Reach)	05→	CR8E	1275			CR8EIX	4218	0.7
	Megalo 125	01→	CR7HSA	4549			CR7HIX	7544	0.6
	Shark 125 / R	99→05	CR8E	1275			CR8EIX	4218	0.8
	Simply 125	08→	CR7HSA	4549			CR7HIX	7544	0.7
	Voyager 125		CR8E	1275			CR8EIX	4218	0.7
	VS 125	06→	CR8E	1275			CR8EIX	4218	0.7
	Wolf 125		DR7EA	7839					0.7
	XS 125		DR7EA	7839					0.7
180	HD Orbit 180	04→	CR8E	1275			CR8EIX	4218	0.7
	Joyride 180	02→	CR8E	1275			CR8EIX	4218	0.7
200	HD Orbit 200		CR8E	1275			CR8EIX	4218	0.7
	Joyride 200		CR8E	1275			CR8EIX	4218	0.7



CC	MODEL	DATE	STANDARD COPPER CORE	STOCK NUMBER	PLATINUM OR GOLD PALLADIUM	STOCK NUMBER	IRIDIUM	STOCK NUMBER	GAP MM
SYM (CONTINUED)									
250	GTS Voyager 250	05→	CR8E	1275			CR8EIX	4218	0.7
300	Citycom 300	08→	CR8E	1275			CR8EIX	4218	0.7
	GTS 300		CR8E	1275			CR8EIX	4218	0.7
500	500 GT/XP	04→	CR7EKB	4455			CR7EIX	7385	0.6

TGB									
50	202 Classic	02→	BPR7HS	6422			BPR7HIX	5944	0.5
	302 Sport	02→	BPR7HS	6422			BPR7HIX	5944	0.5
	303R Hawk	04→	BPR7HS	6422			BPR7HIX	5944	0.5
	AKROStec	03→05	BPR7HS	6422			BPR7HIX	5944	0.5
	Delivery 50	03→	BPR7HS	6422			BPR7HIX	5944	0.5
	R50X	05→	BPR7HS	6422			BPR7HIX	5944	0.5
125	204 Classic	02→07	CR7HSA	4549			CR7HIX	7544	0.7
	303R Hawk	07→	CR7HSA	4549			CR7HIX	7544	0.7
	304 Sport	02→	CR7HSA	4549			CR7HIX	7544	0.7
	404 Executive	02→07	CR7HSA	4549			CR7HIX	7544	0.7
	Delivery 125	05→	CR7HSA	4549			CR7HIX	7544	0.7
	R125X	08→	CR7HSA	4549			CR7HIX	7544	0.7

TOMOS									
50	A3/A5K	84→96	B6HS	4510			BR6HIX	3419	0.5
	AT50, ATX50, NTX50	86→91	B6HS	4510			BR6HIX	3419	0.5

TRIUMPH PRE-1989									
250-500	Twins with 3/4", 19mm Thread Reach		B8ES	2411	B8EVX	7051	BR8EIX	5044	0.6
650	TR6 Thunderbird/Daytona		B6ES	7310					0.6
	TR65 Thunderbird	81→83	B6ES	7310					0.6
750	T140E, T140D Bonneville, TSX4	78→	B6ES	7310					0.6
	T150/160 Trident (Including BSA, A75 and Rocket 3)		B8ES	2411	B8EVX	7051	BR8EIX	5044	0.6
	TR7T Tiger Trail	81→82	B6ES	7310					0.6
	TSX8, TSS		C8E	7471			CR8EIX	4218	0.6

TRIUMPH 1991-ON									
600	Daytona 600	03→04	CR9EK	4548			CR9EIX	3521	0.7
	TT 600	99→03	CR9EK	4548			CR9EIX	3521	0.7
	Speed Four	02→	CR9EK	4548			CR9EIX	3521	0.7
650	Daytona 650	04→05	CR9EK	4548			CR9EIX	3521	0.7
675	Daytona 675 Triple	05→08	CR9EK	4548			CR9EIX	3521	0.7
	Daytona 675 Triple	12/08→	CR9EK	4548			CR9EIX	3521	0.7
	Street Triple	07→	CR9EK	4548			CR9EIX	3521	0.7
	Street Triple R	08→	CR9EK	4548			CR9EIX	3521	0.7
750	Trident, Daytona	91→98	DPR8EA-9	4929			DPR8EIX-9	2202	0.9
790	America	04→06	DPR8EA-9	4929			DPR8EIX-9	2202	0.9
	Bonneville	00→06	DPR8EA-9	4929			DPR8EIX-9	2202	0.9
	Bonneville America	01→06	DPR8EA-9	4929			DPR8EIX-9	2202	0.9
	Bonneville T100	02→04	DPR8EA-9	4929			DPR8EIX-9	2202	0.9
	Speedmaster	02→	DPR8EA-9	4929			DPR8EIX-9	2202	0.9
	Tiger (Non-EFI)	91→98	DPR8EA-9	4929			DPR8EIX-9	2202	0.9
865	America 900	06→	DPR8EA-9	4929			DPR8EIX-9	2202	0.9
	Bonneville 900	06→	DPR8EA-9	4929			DPR8EIX-9	2202	0.9
	Bonneville SE	12/08→	DPR8EA-9	4929			DPR8EIX-9	2202	0.9
	Bonneville T100	04→	DPR8EA-9	4929			DPR8EIX-9	2202	0.9
	Scrambler	05→	DPR8EA-9	4929			DPR8EIX-9	2202	0.9
	Speedmaster	05→	DPR8EA-9	4929			DPR8EIX-9	2202	0.9
	Thrupton 900	03→	DPR8EA-9	4929			DPR8EIX-9	2202	0.9
885	Adventurer	96→01	DPR8EA-9	4929			DPR8EIX-9	2202	0.9
	Daytona, Daytona Super III	91→96	DPR8EA-9	4929			DPR8EIX-9	2202	0.9
	Legend TT	98→01	DPR8EA-9	4929			DPR8EIX-9	2202	0.9
	Speed Triple	94→96	DPR8EA-9	4929			DPR8EIX-9	2202	0.9

2 Wheel



CC	MODEL	DATE	STANDARD COPPER CORE	STOCK NUMBER	PLATINUM OR GOLD PALLADIUM	STOCK NUMBER	IRIDIUM	STOCK NUMBER	GAP MM
TRIUMPH 1991-ON (CONTINUED)									
885	Sprint	91→96	DPR8EA-9	4929			DPR8EIX-9	2202	0.9
	T509 Speed Triple	96→10/98	DPR8EA-9	4929			DPR8EIX-9	2202	0.9
	T709 Tiger	98→	DPR8EA-9	4929			DPR8EIX-9	2202	0.9
	Thunderbird	95→04	DPR8EA-9	4929			DPR8EIX-9	2202	0.9
	Thunderbird Sport	98→04	DPR8EA-9	4929			DPR8EIX-9	2202	0.9
	Tiger	91→	DPR8EA-9	4929			DPR8EIX-9	2202	0.9
	Trident	91→98	DPR8EA-9	4929			DPR8EIX-9	2202	0.9
	Trophy	91→01	DPR8EA-9	4929			DPR8EIX-9	2202	0.9
955	Daytona 955i Ø12mm Plug	98→01	DPR8EA-9	4929			DPR8EIX-9	2202	0.9
	Daytona 955i Ø10mm Plug	01→06	CR9EK	4548			CR9EIX	3521	0.7
	Speed Triple Ø12mm Plug	10/98→01	DPR8EA-9	4929			DPR8EIX-9	2202	0.9
	Speed Triple Ø10mm Plug	01→04	CR9EK	4548			CR9EIX	3521	0.7
	Sprint RS Ø12mm Plug	99→00	DPR8EA-9	4929			DPR8EIX-9	2202	0.9
	Sprint RS Ø10mm Plug	01→05	CR9EK	4548			CR9EIX	3521	0.7
	Sprint ST Ø12mm Plug	98→00	DPR8EA-9	4929			DPR8EIX-9	2202	0.9
	Sprint ST Ø10mm Plug	01→	CR9EK	4548			CR9EIX	3521	0.7
	T595 Daytona	97→98	DPR8EA-9	4929			DPR8EIX-9	2202	0.9
	Tiger EFI	00→07	DPR8EA-9	4929			DPR8EIX-9	2202	0.9
1000	Daytona	91→93	DPR8EA-9	4929			DPR8EIX-9	2202	0.9
1050	Speed Triple	05→	CR9EK	4548			CR9EIX	3521	0.7
	Sprint ST	04→	CR9EK	4548			CR9EIX	3521	0.7
	Tiger	06→	DPR8EA-9	4929			DPR8EIX-9	2202	0.9
1180	Daytona 1200	91→00	DPR8EA-9	4929			DPR8EIX-9	2202	0.9
	Trophy 1200	91→03	DPR8EA-9	4929			DPR8EIX-9	2202	0.9
1600	Thunderbird	09→	DPR8EA-9	5531					0.9
2300	Rocket III (Twin Spark)	04→	DPR8EA-9	4929			DPR8EIX-9	2202	0.9
	Rocket III Classic (Twin Spark)	06→	DPR8EA-9	4929			DPR8EIX-9	2202	0.9
	Rocket III Touring (Twin Spark)	07→	DPR7EA-9	5129	DPR7EVX-9	7682	DPR7EIX-9	7803	0.9

URALMOTO									
650	Cobra, Red Star, Voyage		BP7HS	5111			BPR7HIX	5944	0.8
750	Classic, Wolf		BP6HS	4511			BPR6HIX	4085	0.6

VERTEMATI									
500	S501		CR9EK	4548			CR9EIX	3521	0.7
	SR501		CR9EK	4548			CR9EIX	3521	0.7
570	S570		CR9EK	4548			CR9EIX	3521	0.7

VESPA (See PIAGGIO)

VICTORY (Polaris)									
1507	V92C and all 92 cu.inch models	99→01	DCPR6E	3481					1.0
	V92C and all 92 cu.inch models	02→04	CPR6EB-9	5958					0.8
1634	Hammer, Kingpin, Touring Cruiser	05→08	CPR6EB-9	5958					0.9
	Vegas, Vegas Jackpot, Vegas 8-Ball	05→	CPR6EB-9	5958					0.9
1731	Hammer/S, Vegas Jackpot, Vision Street/Tour	08→	DCPR6E	3481					0.8

VOR									
400	EN, MX, SM	00→	CR8EK	3478			CR8EIX	4218	0.7
503	EN, MX, SM	99→	CR8EK	3478			CR8EIX	4218	0.7
530	530 (2002)	02→	CR8EK	3478			CR8EIX	4218	0.7

WUYANG									
50	WY50QT Scooter	06→	C7HSA	4629			CR7HIX	7544	0.6
125	WY125-12	06→	DPR8EA-9	4929			DPR8EIX-9	2202	0.9
	WY125-16C	06→	DPR8EA-9	4929			DPR8EIX-9	2202	0.9
	WY125-24B Cub	06→	C7HSA	4629			CR7HIX	7544	0.6



CC	MODEL	DATE	STANDARD COPPER CORE	STOCK NUMBER	PLATINUM OR GOLD PALLADIUM	STOCK NUMBER	IRIDIUM	STOCK NUMBER	GAP MM
YAMAHA									
50	CA50 (Salient)	84→87	BP6HS	4511			BPR6HIX	4085	0.6
	CG50E Jog	88→92	BPR7HS	6422			BPR7HIX	5944	0.6
	CS50 Jog R (Air Cooled)	02→07	BR8HS	4322			BR8HIX	7001	0.6
	CS50 Jog-RR (Liquid Cooled 2-Stroke)	03→07	BR8HS	4322			BR8HIX	7001	0.7
	CS50Z Jog RR	07→	BR8HS	4322			BR8HIX	7001	0.7
	CW50 RSP (Spy)	96→	BR8HS	4322			BR8HIX	7001	0.6
	CW50/BW50 NG Bi-Wizz, Booster, Rocket	90→95	BPR7HS	6422			BPR7HIX	5944	0.6
	CW50/BW50 NG Bi-Wizz, Booster, Rocket	96→	BR8HS	4322			BR8HIX	7001	0.6
	CW50T/BW	90→95	BPR7HS	6422			BPR7HIX	5944	0.6
	CW50T/BW	96→	BR8HS	4322			BR8HIX	7001	0.6
	CY50 Jog-in	90→98	BPR7HS	6422			BPR7HIX	5944	0.5
	DT50	04	BR7HS	4122			BR7HIX	7067	0.6
	DT50M/MX	86→95	BR7HS	4122			BR7HIX	7067	0.6
	DT50R		BR9ES	5722			BR9EIX	3981	0.7
	DT50SM	04	BR9ES	5722			BR9EIX	3981	0.7
	EW 50 Slider / Stunt	00→02	BR9HS	4522					0.6
	FS1	87→91	BR7HS	4122			BR7HIX	7067	0.6
	FS1E		B7HS	5110			BR7HIX	7067	0.6
	LC50 Bop 2		BP4HS	3611					0.7
	MA50 M	86→93	BP4HS	3611					0.7
	MS50	85→87	BPR6HS	7022			BPR6HIX	4085	0.6
	PW50 H/J/K/L		BP4HS	3611					0.6
	PW50S		BPR4HS	7823					0.6
	QT50	86→93	BP4HS	3611					0.7
	RD50M/MX	86→89	B7HS	5110			BR7HIX	7067	0.6
	SA50 Pasola	82→86	BP4HS	3611					0.7
	T50	86→89	CR6HS	7023			CR6HIX	7274	0.6
	TY50M		B7HS	5110			BR7HIX	7067	0.6
	TZR50 X-Power	03→04	BR9ES	5722			BR9EIX	3981	0.7
	U50/AD/C/E		B7HS	5110			BR7HIX	7067	0.6
	V50 (1983→)	83→86	BR6ES	4922					0.6
	V50FM		B7HS	5110			BR7HIX	7067	0.6
	V50MA		B6HS	4510			BR6HIX	3419	0.6
	XF50 Giggie	07→	CR7E	4578			CR7EIX	7385	0.8
	YH50 WHY	99→03	BR8HS	4322			BR8HIX	7001	0.6
	YN50 Neo's / Ovetto	98→08	BR7HS	4122			BR7HIX	7067	0.6
	YN50 Neo's 4s	09→	CR7E	4578			CR7EIX	7385	0.8
	YQ50 Aerox / Nitro	98→07	BR8HS	4322			BR8HIX	7001	0.6
	YQ50 Aerox R	04→	BR8HS	4322			BR8HIX	7001	0.6
	YZ50H		B9ES	2611	B9EVX	7254	BR9EIX	3981	0.6
ZE50 (Zest)	93→96	BR7HS	4122			BR7HIX	7067	0.6	
70	V70		B7HS	5110			BR7HIX	7067	0.6
80	CV80	82→86	BPR6HS	7022			BPR6HIX	4085	0.6
	DT80MX	82→85	B8HS	5510	B8HVX	2634	BR8HIX	7001	0.6
	DT80MXS	86→87	BP8HS	2630			BPR8HIX	6742	0.6
	LB2-80 Chappy	81→85	B6HS	4510			BR6HIX	3419	0.6
	PW80K		BP6HS	4511			BPR6HIX	4085	0.6
	PW80S		BPR6HS	7022			BPR6HIX	4085	0.6
	RD80LC11A	82→84	B8ES	2411	B8EVX	7051	BR8EIX	5044	0.6
	T80 Townmate	83→97	CR7HS	7223			CR7HIX	7544	0.6
	TY80B		B6HS	4510			BR6HIX	3419	0.6
	V80	79→87	BPR6HS	7022			BPR6HIX	4085	0.6
	YZ80 (1/2", 12.7mm Thread Reach)		B7HS	5110			BR7HIX	7067	0.5
	YZ80 (3/4", 19mm Thread Reach)	79→	BR9EG	3230			BR9EIX	3981	0.5
	YZ80 B		B8HS	5510	B8HVX	2634	BR8HIX	7001	0.6
	YZ80 C/D		B8ES	2411	B8EVX	7051	BR8EIX	5044	0.6
YZ80 E/F		B10EG	3630	B10EGV	5927	BR10EIX	6801	0.5	
85	YZ85	03→	BR10EG	3830			BR10EIX	6801	0.6
90	TT90-R	03→	CR6HSA	2983			CR6HIX	7274	0.7
	V90		B7HS	5110			BR7HIX	7067	0.5
100	DT100 (C/X)		B7ES	1111			BR7EIX	6664	0.5
	DT100 (D/SD/E)		B8ES	2411	B8EVX	7051	BR8EIX	5044	0.5
	DT100B		B8HS	5510	B8HVX	2634	BR8HIX	7001	0.5
	RS100 (B/X/DX/S)		B8HS	5510	B8HVX	2634	BR8HIX	7001	0.5

2 Wheel



CC	MODEL	DATE	STANDARD COPPER CORE	STOCK NUMBER	PLATINUM OR GOLD PALLADIUM	STOCK NUMBER	IRIDIUM	STOCK NUMBER	GAP MM
YAMAHA (CONTINUED)									
100	RS100P		BP6HS	4511			BPR6HIX	4085	0.5
	RT100		B7ES	1111			BR7EIX	6664	0.6
	RXS100	83→97	BR8HS	4322			BR8HIX	7001	0.6
	YB100	87→92	B7HS	5110			BR7HIX	7067	0.5
	YN100 Neos / Ovetto	11/99→03	BR8HS	4322			BR8HIX	7001	0.5
	YQ100 Aerox / Nitro	00→04	BR8HS	4322			BR8HIX	7001	0.5
	YZ100H		B8EG	3430	B8EGV	5627	BR8EIX	5044	0.5
	YZ100K		B9EG	3530	B9EGV	5827	BR9EIX	3981	0.5
YZ100L		BR9EG	3230			BR9EIX	3981	0.6	
125	AS3		B8HS	5510	B8HVX	2634	BR8HIX	7001	0.6
	BL125 Beluga	85→87	BPR8HS	3725			BPR8HIX	6742	0.6
	Black X-max 125	09→	CPR9EA-9	2308					0.9
	DT125 (E/ED/MX)		B8ES	2411	B8EVX	7051	BR8EIX	5044	0.5
	DT125LC	84→87	BR8ES	5422			BR8EIX	5044	0.6
	DT125R	88→04	BR9ES	5722			BR9EIX	3981	0.6
	DT125RE	04→07	BR8ES	5422			BR8EIX	5044	0.7
	DT125X	04→07	BR8ES	5422			BR8EIX	5044	0.6
	NXC125 Cygnus X	04→	CR7E	4578			CR7EIX	7385	0.8
	RD125 (½", 12.7mm Thread Reach)		B8HS	5510	B8HVX	2634	BR8HIX	7001	0.6
	RD125 C-DX, DX, D-DX (¾", 19mm Thread Reach)		B8ES	2411	B8EVX	7051	BR8EIX	5044	0.6
	RD125LC	85→86	BR9ES	5722			BR9EIX	3981	0.7
	RDZ125	87→89	BR9ES	5722			BR9EIX	3981	0.7
	RS125 (Z/DX)	76→84	B8HS	5510	B8HVX	2634	BR8HIX	7001	0.5
	RS125E		B7HS	5110			BR7HIX	7067	0.6
	SR125	91→03	DR8EA	7162	DR8EVX	6354	DR8EIX	6681	0.6
	T125 (H/J)		B9EG	3530	B9EGV	5827	BR9EIX	3981	0.6
	TDR 125	93→97	BR9ES	5722			BR9EIX	3981	0.7
	TT-R125/LW		CR7HSA	4549			CR7HIX	7544	0.7
	TT-R125E	05→	CR7HSA	4549			CR7HIX	7544	0.7
	TW125	98→04	DR8EA	7162	DR8EVX	6354	DR8EIX	6681	0.6
	TY125		B7ES	1111			BR7EIX	6664	0.6
	TZR125	87→93	BR9ES	5722			BR9EIX	3981	0.7
	TZR125R	93→97	BR9ECM	3252	BR9ECMVX	2434			0.7
	Vity 125	08→	CR7E	4578			CR7EIX	7385	0.6
	VP125 X-City	07→	CPR9EA-9	2308					0.9
	WR125R	09→	CR8E	1275			CR8EIX	4218	0.7
	WR125X	09→	CR8E	1275			CR8EIX	4218	0.7
	XC125	92→96	CR6HSA	2983			CR6HIX	7274	0.6
	XC125 Cygnus	95→99	CR7E	4578			CR7EIX	7385	0.8
	XN125 Teos / Doodo	00→03	CR8E	1275			CR8EIX	4218	0.5
	XQ125 Maxster / Thunder	01→03	CR8E	1275			CR8EIX	4218	0.7
	XT125	82→85	D8EA	2120	D8EVX	2850	DR8EIX	6681	0.7
	XT125R	05→	CR7HSA	4549			CR7HIX	7544	0.7
	XT125X	05→	CR7HSA	4549			CR7HIX	7544	0.7
	XV125 Virago	97→01	CR6HSA	2983			CR6HIX	7274	0.6
	XVS125 Drag Star	99→04	CR7HSA	4549			CR7HIX	7544	0.7
	Y125E/F		BR9EG	3230			BR9EIX	3981	0.5
	YA6		B7HS	5110			BR7HIX	7067	0.6
	YBR125	05→	CR6HSA	2983			CR6HIX	7274	0.6
	YBR125 Custom	09→	CR6HSA	2983			CR6HIX	7274	0.6
	YP125 Majesty / Skyliner	99→	CR8E	1275			CR8EIX	4218	0.7
	YP125R X-Max 125	00→05	CR8E	1275			CR8EIX	4218	0.7
YP125R X-Max 125	06→	CPR9EA-9	2308					0.9	
YZ125 Air Cooled	74→80	B9EG	3530	B9EGV	5827	BR9EIX	3981	0.5	
YZ125 Liquid Cooled	81→91	B9EG	3530	B9EGV	5827	BR9EIX	3981	0.5	
YZ125	91→96	BR9EG	3230			BR9EIX	3981	0.5	
YZ125	96→98	B9EG	3530	B9EGV	5827	BR9EIX	3981	0.5	
YZ125	98→05	BR9EG	3230			BR9EIX	3981	0.5	
YZ125	05→					BR9EIX	3981	0.5	
YZF-R125	08→	CR8E	1275			CR8EIX	4218	0.7	
175	DT175 (E/MX)	78→85	B8ES	2411	B8EVX	7051	BR8EIX	5044	0.5
	IT175H		B9EG	3530	B9EGV	5827	BR9EIX	3981	0.5
	TY175 (E/JC)		B7ES	1111			BR7EIX	6664	0.5



CC	MODEL	DATE	STANDARD COPPER CORE	STOCK NUMBER	PLATINUM OR GOLD PALLADIUM	STOCK NUMBER	IRIDIUM	STOCK NUMBER	GAP MM
YAMAHA (CONTINUED)									
200	CS5E		B8HS	5510	B8HVX	2634	BR8HIX	7001	0.6
	RD200 (All models except B)	76→83	B8ES	2411	B8EVX	7051	BR8EIX	5044	0.6
	RD200B (1/2", 12.7mm Thread Reach)		B8HS	5510	B8HVX	2634	BR8HIX	7001	0.6
	RD200B (3/4", 19mm Thread Reach)		B8ES	2411	B8EVX	7051	BR8EIX	5044	0.6
	RS200		B8ES	2411	B8EVX	7051	BR8EIX	5044	0.6
	WR200E		BR9ES	5722			BR9EIX	3981	0.6
250	Black X-max 250	09→	DR8EA	7162	DR8EVX	6354	DR8EIX	6681	0.7
	DT250 (E/MX)		B8EG	3430	B8EGV	5627	BR8EIX	5044	0.6
	IT250H		B9EG	3530	B9EGV	5827	BR9EIX	3981	0.6
	MX250		B8EG	3430	B8EGV	5627	BR8EIX	5044	0.6
	RD250 (E/F)		B9ES	2611	B9EVX	7254	BR9EIX	3981	0.7
	RD250 (D/LC)	80→85	BR8ES	5422			BR8EIX	5044	0.6
	SR250S	93→95	BP7ES	2412	BP7EVX	7270	BPR7EIX	4055	0.7
	TDR250	88→92	BR9ES	5722			BR9EIX	3981	0.7
	TT250R	03→	CR9E	6263			CR9EIX	3521	0.8
	TY250N		BR8ES	5422			BR8EIX	5044	0.6
	TY250R		BR6ES	4922					0.6
	TY250Z				BP6EVX	5832	BPR6EIX	6637	0.7
	TZR250	87→91	BR9ES	5722			BR9EIX	3981	0.6
	VP250 X-City	07→	DPR8EA-9	4929			DPR8EIX-9	2202	0.9
	WR250F	01→	CR8E	1275			CR8EIX	4218	0.7
	WR250F (S)	04→06	CR8E	1275			CR8EIX	4218	0.7
	WR250F (S)	07→	CR9E	6263			CR9EIX	3521	0.8
	WR250R	08→	CR9EK	4548			CR9EIX	3521	0.8
	WR250X	08→	CR9EK	4548			CR9EIX	3521	0.8
	WR250Z	93→	B8EG	3430	B8EGV	5627	BR8EIX	5044	0.5
	XS250 (E/CW/SE/C)		BP7ES	2412	BP7EVX	7270	BPR7EIX	4055	0.7
	XT250	80→83	BP7ES	2412	BP7EVX	7270	BPR7EIX	4055	0.7
	XV250 Virago	95→00	CR6HS	7023			CR6HIX	7274	0.6
	XVS250 Drag Star	01→	CR6HSA	2983			CR6HIX	7274	0.7
	YP250 Majesty	96→04	DR8EA	7162	DR8EVX	6354	DR8EIX	6681	0.8
	YP250R X-Max	05→	DR8EA	7162	DR8EVX	6354	DR8EIX	6681	0.8
	YZ250 (E-V)		B8EG	3430	B8EGV	5627	BR8EIX	5044	0.6
	YZ250A		B8EG	3430	B8EGV	5627	BR8EIX	5044	0.6
	YZ250E		B8EG	3430	B8EGV	5627	BR8EIX	5044	0.5
	YZ250F (4-Stroke)	01→	CR8E	1275			CR8EIX	4218	0.7
	YZ250F (S)	04→	CR8E	1275			CR8EIX	4218	0.7
	YZ250G (1995 model year)	1995	B8EG	3430	B8EGV	5627	BR8EIX	5044	0.5
YZ250H		B9EG	3530	B9EGV	5827	BR9EIX	3981	0.6	
YZ250WR	→04	B8EG	3430	B8EGV	5627	BR8EIX	5044	0.6	
YZ250WR (2005 model year)	05→	BR8EG	3130			BR8EIX	5044	0.6	
264	VP300 Varsity	03→04	DR8EA	7162	DR8EVX	6354	DR8EIX	6681	0.7
350	RD350 Air Cooled (1/2", 12.7mm Thread Reach)	73→74	B8HS	5510	B8HVX	2634	BR8HIX	7001	0.6
	RD350 Air Cooled (3/4", 19mm Thread Reach)	75→	B8ES	2411	B8EVX	7051	BR8EIX	5044	0.6
	RD350LC-YPVS Liquid Cooled	83→85	BR8ES	5422			BR8EIX	5044	0.6
	RD350 Liquid Cooled	86→95	BR9ES	5722			BR9EIX	3981	0.6
	XT350	85→92	DR8ES-L	2923	DR8EVX	6354	DR8EIX	6681	0.6
400	DT400 (E/MX)		B9ES	2611	B9EVX	7254	BR9EIX	3981	0.6
	FZR400 RR/SP	91→95	CR8E	1275			CR8EIX	4218	0.7
	IT400		B8EG	3430	B8EGV	5627	BR8EIX	5044	0.6
	MX400		B8EG	3430	B8EGV	5627	BR8EIX	5044	0.6
	RD400 (C/D)		B8ES	2411	B8EVX	7051	BR8EIX	5044	0.6
	RD400 (E/F)		B9ES	2611	B9EVX	7254	BR9EIX	3981	0.6
	WR400		CR8E	1275			CR8EIX	4218	0.7
	XS400 (E/2-E/F)		BP7ES	2412	BP7EVX	7270	BPR7EIX	4055	0.6
	YP400 Majesty	04→	CR7E	4578			CR7EIX	7385	0.8
	YZ400 (C/E)		B8EG	3430	B8EGV	5627	BR8EIX	5044	0.6
YZ400F 98→	98→	CR8E	1275			CR8EIX	4218	0.7	
426	WR426F Enduro		CR8E	1275			CR8EIX	4218	0.7
	YZ426F Motocross		CR8E	1275			CR8EIX	4218	0.7
450	WR450F (S)	04→	CR8E	1275			CR8EIX	4218	0.7
	YZ450F	03→	CR8E	1275			CR8EIX	4218	0.7
465	IT465H		B8EG	3430	B8EGV	5627	BR8EIX	5044	0.6
	YZ465H		B8EG	3430	B8EGV	5627	BR8EIX	5044	0.6



CC	MODEL	DATE	STANDARD COPPER CORE	STOCK NUMBER	PLATINUM OR GOLD PALLADIUM	STOCK NUMBER	IRIDIUM	STOCK NUMBER	GAP MM
YAMAHA (CONTINUED)									
490	YZ490 (J/K/L/N/S/T/U)		B8EG	3430	B8EGV	5627	BR8EIX	5044	0.6
500	HL500		BP7ES	2412	BP7EVX	7270	BPR7EIX	4055	0.6
	RD500LC	84→87	BR9HS	4522					0.6
	SR500/E	78→83	BP7ES	2412	BP7EVX	7270	BPR7EIX	4055	0.6
	XP500 TMAX	01→	CR7E	4578			CR7EIX	7385	0.7
	XS500/E		D9EA	2420	D9EVX	2834	DR9EIX	4772	0.6
	XT500 (C/E)	77→83	BP7ES	2412	BP7EVX	7270	BPR7EIX	4055	0.6
535	XV535/S/DX (Virago)	88→04	BPR7ES	2023			BPR7EIX	4055	0.7
550	XJ550	81→85	D8EA	2120	D8EVX	2850	DR8EIX	6681	0.6
	XT550	82→84	DR7ES	3123					0.7
	XZ550	82→85	DR8ES	5423	DR9EVX	6361	DR9EIX	4772	0.7
600	FZ600 Air Cooled	86→88	DR8ES-L	2923	DR8EVX	6354	DR8EIX	6681	0.7
	FZ6-S / Fazer	04→06	CR9EK	4548			CR9EIX	3521	0.8
	FZ6-S S2 / Fazer S2	07→	CR9EK	4548			CR9EIX	3521	0.8
	FZR600 Liquid Cooled	89→94	CR9E	6263			CR9EIX	3521	0.8
	FZR600R	94→96	CR9E	6263			CR9EIX	3521	0.8
	FZS600 Fazer	98→04	CR8E	1275			CR8EIX	4218	0.6
	SRX600	86→89	DPR7EA-9	5129	DPR7EVX-9	7682	DPR7EIX-9	7803	0.9
	TT600	86→03	DPR8EA-9	4929			DPR8EIX-9	2202	0.9
	TT600RE	04→	DPR8EA-9	4929			DPR8EIX-9	2202	0.9
	XJ6 Diversion/ABS	08→	CR9EK	4548			CR9EIX	3521	0.8
	XJ6/ABS	08→	CR9EK	4548			CR9EIX	3521	0.8
	XJ600	84→91	DR8ES-L	2923	DR8EVX	6354	DR8EIX	6681	0.7
	XJ600S/N (Diversion)	92→02	CR8E	1275			CR8EIX	4218	0.6
	XT600	84→88	DPR7EA-9	5129	DPR7EVX-9	7682	DPR7EIX-9	7803	0.9
	XT600E	90→	DPR8EA-9	4929			DPR8EIX-9	2202	0.9
	XT600Z Tenere	84→90	DPR7EA-9	5129	DPR7EVX-9	7682	DPR7EIX-9	7803	0.9
	XT600ZE	86→91	DPR7EA-9	5129	DPR7EVX-9	7682	DPR7EIX-9	7803	0.9
	YZF600R Thunder Cat	96→03	CR9E	6263			CR9EIX	3521	0.8
	YZF-R6	99→05	CR10EK	2360			CR10EIX	6482	0.7
	YZF-R6 (2006)	06→	CR10EK	2360			CR10EIX	6482	0.7
650	XJ650	80→84	BP7ES	2412	BP7EVX	7270	BPR7EIX	4055	0.7
	XJ650T	82→85	BPR8ES	3923					0.7
	XS2		B8ES	2411	B8EVX	7051	BR8EIX	5044	0.6
	XS650 (E/SE/Special)	79→82	BP7ES	2412	BP7EVX	7270	BPR7EIX	4055	0.7
	XVS650 Drag Star	97→	DPR7EA-9	5129	DPR7EVX-9	7682	DPR7EIX-9	7803	0.9
	XVS650A Drag Star	98→	DPR7EA-9	5129	DPR7EVX-9	7682	DPR7EIX-9	7803	0.9
660	MT-03	05→	CR7E	4578			CR7EIX	7385	0.8
	SZR660	95→97	DPR9EA-9	5329			DPR9EIX-9	5545	0.9
	XT660 R/X	04→	CR7E	4578			CR7EIX	7385	0.8
	XT660Z Tenere	08→	CR7E	4578			CR7EIX	7385	0.8
	XTZ660 Tenere	91→99	DPR8EA-9	4929			DPR8EIX-9	2202	0.9
750	FZ750	85→91	DR8ES-L	2923	DR8EVX	6354	DR8EIX	6681	0.6
	FZR750R	87→89	DR8ES-L	2923	DR8EVX	6354	DR8EIX	6681	0.6
	FZR750R OW01	89→91	DR9EA	3437	DR9EVX	6361	DR9EIX	4772	0.6
	FZX750	87→89	DR8ES-L	2923	DR8EVX	6354	DR8EIX	6681	0.6
	XJ750 (SECA)	82→84	BPR7ES	2023			BPR7EIX	4055	0.7
	XS750 (C/D/E/SE)	80→82	BPR7ES	2023			BPR7EIX	4055	0.7
	XTZ750 Super Tenere	89→95	DPR8EA-9	4929			DPR8EIX-9	2202	0.9
	XV750 Virago	92→96	BPR7ES	2023			BPR7EIX	4055	0.7
	YZF750R	93→96	CR9E	6263			CR9EIX	3521	0.7
	YZF750-R7 OW02	99→					R0256R-10	7641	0.8
		YZF750SP	93→96	CR9E	6263			CR9EIX	3521
850	TDM850	91→95	DPR9EA-9	5329			DPR9EIX-9	5545	0.9
	TDM850	96→01	DPR8EA-9	4929			DPR8EIX-9	2202	0.9
	TRX850	96→99	DPR8EA-9	4929			DPR8EIX-9	2202	0.9
	XS850	80→85	BP7ES	2412	BP7EVX	7270	BPR7EIX	4055	0.7
900	TDM 900	02→	DPR8EA-9	4929			DPR8EIX-9	2202	0.9
	XJ900F/S	83→94	BPR8ES	3923					0.7
	XJ900S Diversion	95→04	DPR8EA-9	4929			DPR8EIX-9	2202	0.8
950	XVS950A Midnight Star	09→	CPR7EA-9	3901					0.9
1000	FZR1000	87→88	DR8ES-L	2923	DR8EVX	6354	DR8EIX	6681	0.7
	FZR1000 EXUP	89→93	DR8ES-L	2923	DR8EVX	6354	DR8EIX	6681	0.7
	FZR1000 EXUP	93→95	DR8EA	7162	DR8EVX	6354	DR8EIX	6681	0.8



CC	MODEL	DATE	STANDARD COPPER CORE	STOCK NUMBER	PLATINUM OR GOLD PALLADIUM	STOCK NUMBER	IRIDIUM	STOCK NUMBER	GAP MM
YAMAHA (CONTINUED)									
1000	FZS1000 Fazer	01→05	CR9E	6263			CR9EIX	3521	0.7
	FZ-1 / Fazer	06→	CR9EK	4548			CR9EIX	3521	0.8
	GTS1000A	93→96	DPR8EA-9	4929			DPR8EIX-9	2202	0.9
	TR1	81→85	BP7ES	2412	BP7EVX	7270	BPR7EIX	4055	0.7
	XV1000SE	86→88	BPR7ES	2023			BPR7EIX	4055	0.7
	YZF1000R Thunderace	96→02	DR8EA	7162	DR8EVX	6354	DR8EIX	6681	0.8
	YZF-R1	98→01	CR9E	6263			CR9EIX	3521	0.7
	YZF-R1	02→03					CR9EIA-9	6289	0.9
	YZF-R1	04→08	CR9EK	4548			CR9EIX	3521	0.8
	YZF-R1SP	06	CR9EK	4548			CR9EIX	3521	0.8
	YZF-R1 (26.5mm Thread Reach)	09→	LMAR9E-J	6884					0.7
1100	BT1100 Bulldog	02→06	BPR7ES	2023			BPR7EIX	4055	0.7
	FJ1100	84→85	DPR8EA-9	4929			DPR8EIX-9	2202	0.9
	XS1100 (E/S)	81→84	BP6ES	7811	BP6EVX	5832	BPR6EIX	6637	0.7
	XV1100 Virago	89→98	BPR7ES	2023			BPR7EIX	4055	0.7
	XVS1100/A Drag Star / Classic	99→	BPR7ES	2023			BPR7EIX	4055	0.7
1200	FJ1200/A, XVZ12TD	86→96	DPR8EA-9	4929			DPR8EIX-9	2202	0.9
	V-MAX 1200	91→02	DPR8EA-9	4929			DPR8EIX-9	2202	0.9
	XJR1200	95→98	DPR8EA-9	4929			DPR8EIX-9	2202	0.8
	XVZ12TD Venture	85→86	DPR8EA-9	4929			DPR8EIX-9	2202	0.8
1300	FJR1300/A	01→	CR8E	1275			CR8EIX	4218	0.7
	FJR1300A/AS	06→	CR8E	1275			CR8EIX	4218	0.7
	XJR1300/SP	99→	DPR8EA-9	4929			DPR8EIX-9	2202	0.9
	XVS1300A Midnight Star	07→	LMAR7A-9	4908					0.9
	XVZ1300 TF Venture Star	99→01	DPR8EA-9	4929			DPR8EIX-9	2202	0.8
	XVZ13A Royal Star	96→98	DPR7EA-9	5129	DPR7EVX-9	7682	DPR7EIX-9	7803	0.9
1600	XV1600/A Wild Star	99→02	DPR7EA-9	5129	DPR7EVX-9	7682	DPR7EIX-9	7803	0.9
1670	MT-01 1600 (Twin Spark)	05→	DPR7EA-9	5129	DPR7EVX-9	7682	DPR7EIX-9	7803	0.9
1679	V-Max 1700	08→					CR9EIA-9	6289	0.9
1700	XV1700 Road Star	03→	DPR7EA-9	5129	DPR7EVX-9	7682	DPR7EIX-9	7803	0.9
1900	XV1900 Midnight Star	06→	DPR8EA-9	4929			DPR8EIX-9	2202	0.8



CC	MODEL	DATE	STANDARD COPPER CORE	STOCK NUMBER	PLATINUM OR GOLD PALLADIUM	STOCK NUMBER	IRIDIUM	STOCK NUMBER	GAP MM
APACHE									
50	RLX 50		BR8HSA	5539			BPR8HIX	6742	0.7
	Tomahawk Mini 50		CR7HSA	4549			CR7HIX	7544	0.6
100	Army 100		BR8HSA	5539			BPR8HIX	6742	0.6
	RLX 100		BR8HSA	5539			BPR8HIX	6742	0.6
	SX 100		BR8HSA	5539			BPR8HIX	6742	0.6
	ZX100		BR8HSA	5539			BPR8HIX	6742	0.7
150	RLX 150 H		CR7HSA	4549			CR7HIX	7544	0.6
	RLX 150		CR7HSA	4549			CR7HIX	7544	0.6
	Superbug 150		CR7HSA	4549			CR7HIX	7544	0.6
170	RLX 170 S		DR8EA	7162	DR8EVX	6354	DR8EIX	6681	0.6
250	RLX 250 AX		DR8EA	7162	DR8EVX	6354	DR8EIX	6681	0.6
	RLX 250 S		CR8HS	7423	CR8HVX	7236	CR8HIX	7669	0.7
	RLX 250 SX		CR8HS	7423	CR8HVX	7236	CR8HIX	7669	0.7
300	RLX 320		DPR7EA-9	5129	DPR7EVX-9	7682	DPR7EIX-9	7803	0.9
450	RLX 450		CR8E	1275			CR8EIX	4218	0.7

ARTIC CAT									
50	50	06→	CR7HSA	4549			CR7HIX	7544	0.6
90	90	06→	CR7HSA	4549			CR7HIX	7544	0.6
150	150	09→	DR8EA	7162	DR8EVX	6354	DR8EIX	6681	0.7
250	250	01→	DR7EA	7839					0.6
300	300	05→	DR7EA	7839					0.6
	DVX 300	08→	DPR7EA-9	5129	DPR7EVX-9	7682	DPR7EIX-9	7803	0.9
366	400 H1	08→	CR7E	4578			CR7EIX	7385	0.7
400	400		CR7E	4578			CR7EIX	7385	0.7
500	500		CR6E	6965					0.8
550	550		CPR8E	7411					0.8
650	650	04→05	CR7E	4578			CR7EIX	7385	0.7
	650 H1	05→	CPR8E	7411					0.8
700	700 H1	09→	CPR8E	7411					0.8
950	1000 Thundercat H2	09→	CPR8E	7411					0.8

BLAST (LEM)									
50	50		B7HS	5110			BR7HIX	7067	0.6
100	100		B7HS	5110			BR7HIX	7067	0.6

BOMBARDIER									
50	DS 50 (Rotax)	02→03	BPR7HS	6422			BPR7HIX	5944	0.6
	DS 50	04→06	BR9ECS	3570					0.7
70	DS 7	08→	CR7HSA	4549			CR7HIX	7544	0.7
90	DS 90 (Rotax 2-Stroke)	02→03	BPR7HS	6422			BPR7HIX	5944	0.6
	DS 90 (Rotax 2-Stroke)	04→06	BR9ECS	3570					0.7
	DS 90 (Rotax 4-Stroke)	02→	CR7HSA	4549			CR7HIX	7544	0.6
200	Rally (Rotax)	03→07	CR8E	1275			CR8EIX	4218	0.7
250	DS 250	06→	CR8E	1275			CR8EIX	4218	0.7
330	Outlander 330 HO (Rotax 4-TEC)	04→05	BR9ECS	3570					0.7
400	Outlander 400 HO (Rotax 4-TEC) Ø12mm Plug	03→	DCPR8E*	4179			DCR8EIX	3606	0.6
	Outlander 400 Ø14mm plug	04→	BR9ECS	3570					0.7
450	DS 450	08→	DCPR9E	2641			DCR9EIX	6650	0.7
500	Outlander 500	07→	DCPR8E*	4179			DCR8EIX	3606	0.7
	Renegade 500	08→	DCPR8E*	4179			DCR8EIX	3606	0.7
	Traxter (Rotax) Ø12mm Plug	98→02	DR8EA	7162	DR8EVX	6354	DR8EIX	6681	0.7
	Traxter (Rotax) Ø14mm plug	03→	BR9ECS	3570					0.7
	Traxter CVT	05	DCPR8E*	4179			DCR8EIX	3606	0.7
650	DS 650 (Rotax) Ø12mm Plug	00→07	DR8EA	7162	DR8EVX	6354	DR8EIX	6681	0.7
	Outlander 650	06→	DCPR8E*	4179			DCR8EIX	3606	0.7
	Quest 650 (Rotax 4-TEC) Ø12mm Plug	02→03	DR8EA	7162	DR8EVX	6354	DR8EIX	6681	0.7
	Quest 650 Ø14mm plug	03→	BR9ECS	3570					0.7
	Traxter CVT	05	DCPR8E*	4179			DCR8EIX	3606	0.7
800	Outlander 800	06→	DCPR8E*	4179			DCR8EIX	3606	0.7
	Renegade 800	07→	DCPR8E*	4179			DCR8EIX	3606	0.7



* Please note DCPR8E 4339 has a removable terminal nut, whereas DCPR8E 4179 has a fixed terminal nut





CC	MODEL	DATE	STANDARD COPPER CORE	STOCK NUMBER	PLATINUM OR GOLD PALLADIUM	STOCK NUMBER	IRIDIUM	STOCK NUMBER	GAP MM
CPI									
50	ATV 50		BR7HS	4122			BR7HIX	7067	0.7
	XT50R		BR7HS	4122			BR7HIX	7067	0.7
100	ATV 100		BR7HS	4122			BR7HIX	7067	0.7
200	ATV 200		BR7HS	4122			BR7HIX	7067	0.7

DINLI									
50	JP 502		BPR7HS	6422			BPR7HIX	5944	0.7
150	Diablo 150		C7HSA	4629			CR7HIX	7544	0.7

E-TON									
40	JXL40 Viper	03→	BPM7A	7321					0.6
	RXL 40E		BPM7A	7321					0.6
50	RXL50 Viper	02→	BPR7HS	6422			BPR7HIX	5944	0.7
70	RXL 70		BPR7HS	6422			BPR7HIX	5944	0.7
90	DXL90 Sierra	03→	BPR7HS	6422			BPR7HIX	5944	0.7
	RXL90 R		BPR7HS	6422			BPR7HIX	5944	0.7
	RXL90 Viper	02→	BPR7HS	6422			BPR7HIX	5944	0.7
150	CXL150 Challenger	99→	C7HSA	4629			CR7HIX	7544	0.7
	YXL150 Yukon	99→	C7HSA	4629			CR7HIX	7544	0.7

GAS GAS									
50	Quad 50		B9ES	2611	B9EVX	7254	BR9EIX	3981	0.6
250	Quad 250	07	DPR7EA-9	5129	DPR7EVX-9	7682	DPR7EIX-9	7803	0.7
300	Wild HP	03	BR8EG	3130			BR8EIX	5044	0.5
450	Wild HP	03	CR8E	1275			CR8EIX	4218	0.7

HONDA									
70	ATC70-D,ATC70	78→85	CR7HS	7223			CR7HIX	7544	0.7
90	TRX90 Sportrax	94→95	CR6HSA	2983			CR6HIX	7274	0.6
110	ATC110	79→85	DR8HS	5123					0.7
125	ATC125M	84→87	DR8ES-L	2923	DR8EVX	6354	DR8EIX	6681	0.7
	TRX125 All variants	85→88	DR8ES-L	2923	DR8EVX	6354	DR8EIX	6681	0.7
185	ATC185S-D	79→82	DR8ES-L	2923	DR8EVX	6354	DR8EIX	6681	0.7
200	ATC200 (EC/XD/ESE)	81→84	DR8ES-L	2923	DR8EVX	6354	DR8EIX	6681	0.7
	TRX200 All variants	84→97	DR8ES-L	2923	DR8EVX	6354	DR8EIX	6681	0.7
250	ATC250R-D	81→83	BR8ES	5422			BR8EIX	5044	0.7
	ATC250R-F/G	85→86	BR9ES	5722			BR9EIX	3981	0.7
	TRX250 RH, RJ, RK	86→89	BR9ES	5722			BR9EIX	3981	0.7
	TRX250 EX Sportrax	01→08	DPR8EA-9	4929			DPR8EIX-9	2202	0.9
	TRX250 TM/TE Fourtrax S/ES	02→	DPR8EA-9	4929			DPR8EIX-9	2202	0.9
300	TRX300FW-V	94→99	DPR8EA-9	4929			DPR8EIX-9	2202	0.9
	TRX300EX	00→01	DR8ES-L	2923	DR8EVX	6354	DR8EIX	6681	0.7
350	TRX350-H, J, K, L, M, N, P	86→93	DR8ES-L	2923	DR8EVX	6354	DR8EIX	6681	0.7
	TRX350 TM/TE Fourtrax S/ES	01→03	DPR7EA-9	5129	DPR7EVX-9	7682	DPR7EIX-9	7803	0.9
400	TRX400AT Fourtrax	05→	DPR8EA-9	4929			DPR8EIX-9	2202	0.9
	TRX400EX Sportrax	05→	DPR8EA-9	4929			DPR8EIX-9	2202	0.9
420	TRX420 FE/FM/TE/TM Fourtrax ES	07→	BKR5E-11	6953			BKR5EIX-11	5464	1.1
450	TRX450 FE/FM ES/S	97→02	DPR7EA-9	5129	DPR7EVX-9	7682	DPR7EIX-9	7803	0.9
	TRX450R Sportrax	06→					IFR8H11	5068	1.1
475	TRX500 ES/FM/FE Foreman (Ø14mm Plug)		BKR5E-11	6953			BKR5EIX-11	5464	1.1
500	TRX500 FA1, FA2, FA3 Foreman AT (Ø12mm Plug)	01→					IJR7A9	7901	0.9
650	TRX650FA Rincon AT	04→					IFR5L11	6502	1.1
680	TRX680FA Rincon	05→					IFR5L11	6502	1.1

HYOSUNG									
50	TE50		BPR6HS	7022			BPR6HIX	4085	0.7
90	TE90		BPR7HS	6422			BPR7HIX	5944	0.7
100	TE100R		BPR7HS	6422			BPR7HIX	5944	0.7
450	TE450 Rapier	07→	CR8E	1275			CR8EIX	4218	0.7



CC	MODEL	DATE	STANDARD COPPER CORE	STOCK NUMBER	PLATINUM OR GOLD PALLADIUM	STOCK NUMBER	IRIDIUM	STOCK NUMBER	GAP MM
KAWASAKI									
50	KFX50 A	03→	BPR4HS	7823					0.7
220	KLF220 A	88→02	DR8ES	5423	DR9EVX	6361	DR9EIX	4772	0.7
250	KLF250	03→	DR8ES	5423	DR9EVX	6361	DR9EIX	4772	0.6
300	KAF300 A-C (Mule 500/550)	91→04	BPR5ES	7422			BPR5EIX	6597	0.8
	KLF300 (Ø14mm plug)	86→88	BR8ES	5422			BR8EIX	5044	0.6
	KLF300 (Ø12mm plug)	89→	DR8EA	7162	DR8EVX	6354	DR8EIX	6681	0.7
	KVF300	99→	DR8EA	7162	DR8EVX	6354	DR8EIX	6681	0.7
360	KVF360	02→	DPR8EA-9	4929			DPR8EIX-9	2202	0.9
400	KAF400 A-B (Mule 600)	05→	BPR6ES	7822			BPR6EIX	6637	0.6
	KFX400	03→	CR7E	4578			CR7EIX	7385	0.7
	KLF400 B	93→99	DPR8EA-9	4929			DPR8EIX-9	2202	0.9
	KVF400	99→	DPR8EA-9	4929			DPR8EIX-9	2202	0.9
540	KAF540 C (Mule 2010)	02→05	BP5ES	6511			BPR5EIX	6597	0.5
620	KAF620 D (Mule 2500E)	90	BMR4A	5728					0.7
	KAF620 A-D (Mule 2510/2500)	93→00	BMR2A	7677					0.7
	KAF620 E ,G (Mule 3010/3000)	01→	BPR2ES	2264					0.7
650	KVF650	02→	CR7E	4578			CR7EIX	7385	0.7
700	KFX700 V Force	04→	CR7E	4578			CR7EIX	7385	0.7
	KVF700 A	04→	CR7E	4578			CR7EIX	7385	0.7
750	KVF750 A	05→	CR7E	4578			CR7EIX	7385	0.7
950	KAF950 B Diesel (Mule 3010)	03→	Y-706R	3041					-

KTM									
450	450 SX (Ø10mm plug)	09→	CR9EKB	2305			CR9EIX	3521	0.7
	450 XC (Ø12mm plug)	08→	DCPR8E*	4179			DCR8EIX	3606	0.6
477	505 SX (Ø10mm plug)	09→	CR9EKB	2305			CR9EIX	3521	0.7
510	525 XC (Ø12mm plug)	08→	DCPR8E*	4179			DCR8EIX	3606	0.6

KYMCO									
50	KXR 50		BR8HSA	5539			BPR8HIX	6742	0.6
90	KXR 90		C7HSA	4629			CR7HIX	7544	0.7
150	MXer 150 /RL	01→	DR8EA	7162	DR8EVX	6354	DR8EIX	6681	0.7
	MXU 150 RL	05→	DR8EA	7162	DR8EVX	6354	DR8EIX	6681	0.7
250	KXR 250 /RL	01→	DPR7EA-9	5129	DPR7EVX-9	7682	DPR7EIX-9	7803	0.9
	MXU 250 RL Maxxer 250		DPR7EA-9	5129	DPR7EVX-9	7682	DPR7EIX-9	7803	0.9
300	MXU 300 RL, Maxxer 300	05→	DPR7EA-9	5129	DPR7EVX-9	7682	DPR7EIX-9	7803	0.9
400	MXU 400		CR8E	1275			CR8EIX	4218	0.7
500	MXU 500		CR7E	4578			CR7EIX	7385	0.6
	UXV 500		CR7E	4578			CR7EIX	7385	0.9

LEM									
50	Beetlebug, Cayman, Condor	97→	B7HS	5110			BR7HIX	7067	0.6

MASAI									
265	A300		DCPR7E	3932	DCPR7EVX	1179	DCR7EIX	3605	0.8
450	A450		DCPR8E*	4179			DCR8EIX	3606	0.6

MASSEY FERGUSON									
250	MF250 2WD		DR7EA	7839					0.6
350	MF350MRP 4 X 4WD Manual 5 Speed		DR7EA	7839					0.6
400	MF400MRP 4WD Manual 5 Speed		CR6E	6965					0.8
450	MF450MRP 4WD Automatic		CR6E	6965					0.8
500	MF500MRP 4WD Automatic & Manual 5 Speed		CR6E	6965					0.8
	MF500TBX 4WD Automatic		CR6E	6965					0.8



* Please note DCPR8E 4339 has a removable terminal nut, whereas DCPR8E 4179 has a fixed terminal nut





CC	MODEL	DATE	STANDARD COPPER CORE	STOCK NUMBER	PLATINUM OR GOLD PALLADIUM	STOCK NUMBER	IRIDIUM	STOCK NUMBER	GAP MM
MOTO-ROMA									
50	Blazer 50		B8HS	5510	B8HVX	2634	BR8HIX	7001	0.5
	Blazer 50DL		BP7HS	5111			BPR7HIX	5944	0.6
90	Sport 90		BP7HS	5111			BPR7HIX	5944	0.7
100	Blazer 100		BP7HS	5111			BPR7HIX	5944	0.5
	Roadrunner 4	04→	BP7HS	5111			BPR7HIX	5944	0.6
	Sport 100		BP7HS	5111			BPR7HIX	5944	0.6
125	Sportsman 125	03→	C7HSA	4629			CR7HIX	7544	0.6
	SS Buggy (AB125E,R)		C7HSA	4629			CR7HIX	7544	0.6
150	DS Buggy (AB150IIR)		C7HSA	4629			CR7HIX	7544	0.6
	Sport/Sportsman 150		C7HSA	4629			CR7HIX	7544	0.6
	X Machine		C7HSA	4629			CR7HIX	7544	0.6
250	Sport 250		C7HSA	4629			CR7HIX	7544	0.6
	Sportsman 250		C7HSA	4629			CR7HIX	7544	0.6

POLARIS									
50	Predator 50	03→	BPR7HS	6422			BPR7HIX	5944	0.6
90	Predator 90	03→	BPR7HS	6422			BPR7HIX	5944	0.6
	Sportsman 90		BPR7HS	6422			BPR7HIX	5944	0.6
200	Phoenix 200	05→	CR6HSA	2983			CR6HIX	7274	0.7
	Sawtooth	06→	CR7HSA	4549			CR7HIX	7544	0.7
250	Trail Blazer 250		BR8ES	5422			BR8EIX	5044	0.7
300	Hawkeye 300 2x4, 4x4	06→	CR8EB	7784			CR8EIX	4218	0.8
330	Magnum 330		BKR6E	6962	BKR6EVX	3539	BKR6EIX	6418	0.9
	Trial Boss 330		BKR6E	6962	BKR6EVX	3539	BKR6EIX	6418	0.9
450	Sportsman 450		BKR6E	6962	BKR6EVX	3539	BKR6EIX	6418	0.9
500	Predator 500	05→	DCPR8E*	4339			DCR8EIX	3606	0.9
	Predator Troy Lee	06→	DCPR8E*	4339			DCR8EIX	3606	0.9
	Ranger 4x4 EFI		BKR6E	6962	BKR6EVX	3539	BKR6EIX	6418	0.9
	Scrambler 500		BKR6E	6962	BKR6EVX	3539	BKR6EIX	6418	0.9
	Sportsman 500 EFI		BKR6E	6962	BKR6EVX	3539	BKR6EIX	6418	0.9
650	Ranger TM	06→	BPR5ES	7422			BPR5EIX	6597	0.9
680	Ranger 6x6 EFI		BKR7E	6097	BKR7EVX	3544	BKR7EIX	2667	0.9
	Ranger XP		BKR7E	6097	BKR7EVX	3544	BKR7EIX	2667	0.9
700	Sportsman 700 EFI		BKR7E	6097	BKR7EVX	3544	BKR7EIX	2667	0.9
	Sportsman 700 Twin		BKR7E	6097	BKR7EVX	3544	BKR7EIX	2667	0.9
800	Sportsman 800 EFI		BKR7E	6097	BKR7EVX	3544	BKR7EIX	2667	0.9

QUADZILLA									
50	Buzz		BPR7HS	6422			BPR7HIX	5944	0.6
100	M100		BP7HS	5111			BPR7HIX	5944	0.7
	ProShark		BP8ES	2912	BP8EVX	2671	BPR8EIX	6684	0.6
	ProShark E		BR8HSA	5539			BPR8HIX	6742	0.6
	ProShark Type R		BP8ES	2912	BP8EVX	2671	BPR8EIX	6684	0.6
	R100		BPR7HS	6422			BPR7HIX	5944	0.6
	X100 Single piece head (12.7mm Thread Reach)		BR8HSA	5539			BPR8HIX	6742	0.6
	X100 Twin piece head (19mm Thread Reach)		BP8ES	2912	BP8EVX	2671	BPR8EIX	6684	0.6
165	R170E Stinger		DR8EA	7162	DR8EVX	6354	DR8EIX	6681	0.7
200	200E 4 Cross		DR8EA	7162	DR8EVX	6354	DR8EIX	6681	0.7
	ST200E		CR7HSA	4549			CR7HIX	7544	0.6
250	PGO 250E Bugrider		DPR7EA-9	5129	DPR7EVX-9	7682	DPR7EIX-9	7803	0.9
	R250E Stinger		CR8HS	7423	CR8HVX	7236	CR8HIX	7669	0.7
	R250E Triple Disc		CR8HS	7423	CR8HVX	7236	CR8HIX	7669	0.7
	XRV 250		DPR7EA-9	5129	DPR7EVX-9	7682	DPR7EIX-9	7803	0.9
300	300E SUV 4 Valve		DR8EA	7162	DR8EVX	6354	DR8EIX	6681	0.7



* Please note DCPR8E 4339 has a removable terminal nut, whereas DCPR8E 4179 has a fixed terminal nut



ATV Quad



CC	MODEL	DATE	STANDARD COPPER CORE	STOCK NUMBER	PLATINUM OR GOLD PALLADIUM	STOCK NUMBER	IRIDIUM	STOCK NUMBER	GAP MM
SUZUKI									
50	LT50 →K4/K5		BPR4HS	7823					0.7
	LT-A50 →K4/K5		BPR4HS	7823					0.7
	LT-Z50 K5/K6	05→	CR6HSA	2983			CR6HIX	7274	0.7
80	LT80 P-R-S		BP7HS	5111			BPR7HIX	5944	0.7
	LT80 T-V-W-X-Y K1-K5		BPR7HS	6422			BPR7HIX	5944	0.7
90	LT-Z90	06→	CR6HSA	2983			CR6HIX	7274	0.7
250	LT-4WD	87→98	DR7ES	3123					0.7
	LT-F250F Ozark	99→02	DR7EA	7839					0.6
	LT-F250	03→	DR7EA	7839					0.6
	LT-Z250 K4-K5	04→	DR7EA	7839					0.6
300	LT-F300F	99→02	DR7EA	7839					0.7
400	LT-A400F K2 (Eiger)	02→	CR7E	4578			CR7EIX	7385	0.7
	LT-F400 Eiger 2WD		CR7E	4578			CR7EIX	7385	0.7
	LT-F400F Eiger 4WD	02→	CR7E	4578			CR7EIX	7385	0.7
	LT-Z400	03→	CR7E	4578			CR7EIX	7385	0.7
450	LT-A450X	07→	CR6E	6965					0.8
	LT-R450	06→	CR8EB	7784			CR8EIX	4218	0.7
500	LT-F500F	98→07	CR7E	4578			CR7EIX	7385	0.7
700	LT700A K5	05→	CR6E	6965					0.8
	LT-A700X K7	07→	CR6E	6965					0.8
722	LT-A750X	08→	CR6E	6965					0.8

SYM									
200	TrackRunner 200	06→	CR8HSA	2086	CR8HVX	7236	CR8HIX	7669	0.6
250	QuadLander 250	06→	BR8HSA	5539			BPR8HIX	6742	0.6

TGB									
90	Hornet 90		BPR7HS	6422			BPR7HIX	5944	0.6
250	Blade 250		CR8E	1275			CR8EIX	4218	0.8

YAMAHA									
50	YFM50 Mini Raptor	03→05	CR7HS	7223			CR7HIX	7544	0.6
	YFM50 Mini Raptor	06→	CR7HSA	4549			CR7HIX	7544	0.7
60	YT60L (Tri-Moto)		BP6HS	4511			BPR6HIX	4085	0.6
80	YFM80	92→03	CR7HS	7223			CR7HIX	7544	0.7
	YFM80 Badger	04→	CR7HSA	4549			CR7HIX	7544	0.7
	YFM80 Raptor	06→	CR7HSA	4549			CR7HIX	7544	0.7
125	YFA1 Breeze	90→03	CR7HS	7223			CR7HIX	7544	0.7
	YFA1 Breeze	04→	CR7HSA	4549			CR7HIX	7544	0.7
	YFM125S Grizzly	04→	CR7HSA	4549			CR7HIX	7544	0.7
200	YTM200EL Yamahauler	84	D7EA	7912					0.7
	YFM200N (Moto-4)	85→90	D7EA	7912					0.6
	YFS200 Blaster	88→	BR8ES	5422			BR8EIX	5044	0.6
	YTM200EK (Tri-Moto)		D7EA	7912					0.6
225	YFM225		DR7ES	3123					0.6
230	YFU1 Pro Hauler	89→90	DR7EA	7839					0.7
250	YFB250 Timberwolf 2WD/4WD	92→97	DR7EA	7839					0.6
	YFM250	88→90	DR7EA	7839					0.7
	YFM250X Beartracker	99→04	DR7EA	7839					0.7
	YFM250 Bear Tracker	05→	DR7EA	7839					0.6
	YFM250B Bruin/Big Bear	05→	DR7EA	7839					0.6
350	G23A Utility/Golf Kart	03→06	BPR2ES	2264					0.7
	YFM350 Big Bear 2WD		DR8ES-L	2923	DR8EVX	6354	DR8EIX	6681	0.6
	YFM350 Big Bear 4WD	87→93	DR8ES-L	2923	DR8EVX	6354	DR8EIX	6681	0.6
	YFM350 Big Bear 4WD	94→97	DR8EA	7162	DR8EVX	6354	DR8EIX	6681	0.8
	YFM350A, FWA Bruin 2WD/4WD	03→	DR8EA	7162	DR8EVX	6354	DR8EIX	6681	0.8
	YFM350ER	93→95	DR8ES	5423	DR9EVX	6361	DR9EIX	4772	0.7
	YFM350FWB	97→01	DR8EA	7162	DR8EVX	6354	DR8EIX	6681	0.7
	YFM350FX Wolverine	95→99	DR8EA	7162	DR8EVX	6354	DR8EIX	6681	0.7
	YFM350R Raptor	05→	DR8EA	7162	DR8EVX	6354	DR8EIX	6681	0.8
	YFM350U	96→01	DR8EA	7162	DR8EVX	6354	DR8EIX	6681	0.7



CC	MODEL	DATE	STANDARD COPPER CORE	STOCK NUMBER	PLATINUM OR GOLD PALLADIUM	STOCK NUMBER	IRIDIUM	STOCK NUMBER	GAP MM
YAMAHA (CONTINUED)									
350	YFM350X Warrior	87→04	DR8EA	7162	DR8EVX	6354	DR8EIX	6681	0.8
	YFZ350 Banshee	87→	BR8ES	5422			BR8EIX	5044	0.6
360	G27A U-Max Golf Kart	04→06	BPR2ES	2264					0.7
	YDR-A (The DRIVE)	07→	BPR2ES	2264					0.7
400	YFM400 Big Bear Professional Manual	00→06	DR8EA	7162	DR8EVX	6354	DR8EIX	6681	0.7
	YFM40 Big Bear Manual	07→	DR8EA	7162	DR8EVX	6354	DR8EIX	6681	0.7
	YFM400FWE Kodiak	93	DR8ES-L	2923	DR8EVX	6354	DR8EIX	6681	0.7
	YFM400 Kodiak Manual	94→99	DR8EA	7162	DR8EVX	6354	DR8EIX	6681	0.7
	YFM400 Kodiak Auto	00→05	DR8EA	7162	DR8EVX	6354	DR8EIX	6681	0.7
	YFM4FAV Kodiak Auto	06	DR8EA	7162	DR8EVX	6354	DR8EIX	6681	0.7
450	YFM450F Kodiak	03→05	DR8EA	7162	DR8EVX	6354	DR8EIX	6681	0.8
	YFM45 Kodiak	06	DR8EA	7162	DR8EVX	6354	DR8EIX	6681	0.8
	YFM45 Grizzly	07→	DR8EA	7162	DR8EVX	6354	DR8EIX	6681	0.8
	YFZ450	03→	CR8E	1275			CR8EIX	4218	0.8
	YFZ450R	09→	CR8E	1275			CR8EIX	4218	0.8
600	YFM600FWA Grizzly	98→01	DPR8EA-9	4929			DPR8EIX-9	2202	0.9
660	YFM660FWA Grizzly	02→	DPR8EA-9	4929			DPR8EIX-9	2202	0.9
	YFM660R Raptor	01→05	DPR8EA-9	4929			DPR8EIX-9	2202	0.9
	YXR660 Rhino	04→07	DPR8EA-9	4929			DPR8EIX-9	2202	0.9
700	YXR70FX Rhino Fi	08→	CPR7EA-9	3901					0.8
	YFM700R Raptor	06→	CR8E	1275			CR8EIX	4218	0.6
	YFM700 Grizzly Fi	07→	CPR7EA-9	3901					0.9
	YFM700FWAD Grizzly Fi (26.5mm Thread Reach)	09→	LMAR6A-9	5946					0.9

CONVERSION CHART

IMPORTANT:

This chart is furnished as a guide only. Certain design differences may exist between our spark plugs and another manufacturers; heat ratings can also vary. Always refer to the main application data to select the recommended spark plug for specific engines.

AC DELCO	NGK → STOCK No.	AC DELCO	NGK → STOCK No.	AC DELCO	NGK → STOCK No.	AC DELCO	NGK → STOCK No.				
40TS	BP7FS	3612	C42CXLS	BP6ES	7811	FR5LS	BCPR5ES	6130	R44F	BR5HS	3722
41-2XLS	BP7ES	2412	C42LTS	BP6EFS	3812	LM46	B4LM	3410	R44LTS	BPR5EFS	2223
41-4XLS	BP6ES	7811	C42N	B7ES	1111	LM49	B4LM	3410	R44N	BR6ES	4922
41-932	PTR5D-13	6644	C42XLS	BP5ES	6511	M40FFX	B9HS-10	3626	R44NS	BPR5ES	7422
41-933	PTR4B-15	5146	C43	B6S	3510	M41FF	B8HS	5510	R44S	BP5S	3011
41-985	ITR6F13	4477	C43CXLS	BP6ES	7811	M41K	B8S	3810	R44T	BR5FS	4123
41TS	BP6FS	3512	C43L	B6L	3212	M42FF	B7HS	5110	R44TS	BPR5FS	2423
41XL	B9ES	2611	C43N	B6ES	7310	M42K	B7S	3710	R44TSX	BPR5FS-15	3124
41XLS	BP7ES	2412	C44	B6S	3510	M43FF	B6HS	4510	R44TX	BR5FS-15	2224
420Z	B4H	4110	C44N	B6ES	7310	M44C	B6S	3510	R44XL	BR6ES	4922
422Z	B5HS	4210	C44NS	BP5ES	6511	M44L	B6L	3212	R44XLS	BPR5ES	7422
425Z	B6HS	4510	C44S	BP5S	3011	M45	B4	3210	R44XLSE	ZGR5C	6334
42-6FS	BP6HS	4511	C44XL	B6ES	7310	M45FF	B5HS	4210	R44XLSM	ZGR5C	6334
42F	B6HS	4510	C45	B4	3210	M47	B4	3210	R45NS	BPR5ES	7422
42FS	BP6HS	4511	C45L	B4L	3112	MB42K	B6S	3510	R45NSX	BPR5ES-13	3154
42TS	BP6FS	3512	C49	B2	3110	MR42K	BR6S	3522	R45S	BP5S	3011
42XL	B8ES	2411	C73	G2Z	3320	MR43LTS	BPR6EFS	3623	R45T	BR5FS	4123
42XLS	BP6ES	7811	C75	G2Z	3320	MR43T	BR6FS	4323	R45TS	BPR4FS	1127
430Z	B7HS	5110	C81	A8	1210	MR44C	BR6S	3522	R45TSX	BPR4FS-15	2727
436XLS	BP9ES	7526	C82	A7	1110	MR44T	BR5FS	4123	R45XL	BR6ES	4922
438XLS	BP8ES	2912	C82	AB7	3010	R41-5TS	BPR6FS	2623	R45XLS	BPR5ES	7422
43FS	BP6HS	4511	C83	A7	1110	R41CF	BR7HS	4122	R46	BR6S	3522
43N	B7ES	1111	C83	AB7	3010	R41CXL	BR9ES	5722	R46LTS	BPR5EFS	2223
43TS	BP6FS	3512	C83T	A6FS	2210	R41CXLS	BPR7ES	2023	R46N	BR5ES	4722
43XL	B7ES	1111	C84T	A6FS	2210	R41TS	BPR6FS	2623	R46S	BP4	2911
43XLS	BP6ES	7811	C86	A6	1010	R42-5LTS	BPR6EFS	3623	R46T	BR5FS	4123
44	B6S	3510	C86	AB6	2910	R42-5TS	BPR6FS	2623	R46TS	BPR4FS	1127
440T	B7FS	3027	C87	A6	1010	R42-6FS	BPR6HS	7022	R46TSX	BPR4FS-15	2727
440XLS	BP8ES	2912	C87	AB6	2910	R42CF	BR6HS	3922	R46TX	BR5FS-15	2224
445Z	B8HS	5510	C88	AB2	3020	R42CFS	BPR6HS	7022	R46XL	BR5ES	4722
44F	B5HS	4210	C88L	AB2	3020	R42CLTS	BPR6EFS	3623	R46XLS	BPR4ES	7222
44FFS	BP5HS	4111	CFR1CLS	BCPR7ES	3330	R42CT	BR6FS	4323	R47S	BP4	2911
44N	B6ES	7310	CFR2CLS	BKR6E	6962	R42CTS	BPR6FS	2623	R83CTS	APR6FS	2922
44NS	BP5ES	6511	CR42CFS	BPR6FS	2623	R42CXL	BR8ES	5422	R83TS	APR6FS	2922
44S	BP5S	3011	CR42CXLS	BPR6ES	7822	R42CXLS	BPR6ES	7822	R84TS	APR5FS	3122
44TS	BP5FS	3412	CR42N	BR7ES	5122	R42FS	BPR6HS	7022	R85TS	APR5FS	3122
44XL	B6ES	7310	CR43	BR6S	3522	R42LTS	BPR6EFS	3623	S102F	C7HSA	4629
44XLO	BP5ES	6511	CR43CXLS	BPR6ES	7822	R42T	BR6FS	4323	S104F	C6HSA	3228
44XLS	BP5ES	6511	CR43K	BR6S	3522	R42TS	BPR6FS	2623	S121F	D8HA	7112
45	B4	3210	CR43N	BR6ES	4922	R42TSM	BPR6FS	2623	S121XL	D8EA	2120
45F	B5HS	4210	CR43TS	BPR5FS-11	2924	R42XL	BR8ES	5422	S122F	D8HA	7112
45FFS	BP5HS	4111	CR43TSM	BPR5FS-11	2924	R42XLS	BPR6ES	7822	S123XL	D7EA	7912
45L	B4L	3112	CR44N	BR6ES	4922	R42XLSM	ZGR5C	6334	S124FS	D6HA	6512
45NS	BP5ES	6511	CR44NS	BPR5ES	7422	R43	BR6S	3522	S404XLG	B10EG	3630
45S	BP5S	3011	CR44TS	BPR5FS-11	2924	R43C	BR6S	3522	S408XLG	B9EG	3530
45XL	B6ES	7310	CS40	BM7A	6521	R43CFS	BPR6HS	7022	S40F	B9HS	5810
45XLS	BP5ES	6511	CS41	BM7A	6521	R43CT	BR6FS	4323	S40FR	BR9HS	4522
46	B4	3210	CS41T	BM7F	6421	R43CTS	BPR6FS	2623	S40XLG	B9ECS	7058
46F	B5HS	4210	CS42	BM7A	6521	R43CTS6	BPR6FS	2623	S40XLR	BR8ES	5422
46FFS	BP5HS	4111	CS42S	BM7A	6521	R43CXL	BR7ES	5122	S41F	B8HS	5510
46N	B5ES	6410	CS42T	BM6F	6221	R43CXLS	BPR6ES	7822	S41FR	BR8HS	4322
46S	BP5S	3011	CS45	BM6A	5921	R43FS	BPR6HS	7022	S41XL	B9ES	2611
46XL	B5ES	6410	CS45T	BM6F	6221	R43LTS	BPR6EFS	3623	S41XLG	B8ECS	2821
47XL	B4ES	4129	CS49	BM4A	5628	R43N	BR7ES	5122	S41XLR	BR9ES	5722
83CTS	AP6FS	2710	CSR45	BMR6A	7421	R43T	BR6FS	4323	S42	B7S	3710
83TS	AP6FS	2710	FR2LS	BKR6E	6962	R43TS	BPR6FS	2623	S42F	B7HS	5110
84T	A6FS	2210	FR2LSK	BKR6E	6962	R43TSK	BPR6FS	2623	S42FR	BR7HS	4122
B4031	B4	3210	FR3CLS	BKR5E	7938	R43TSX	BPR6FS	2623	S42XL	B8ES	2411
B43	B6S	3510	FR3CLS6	BKR5E-11	6953	R43XL	BR7ES	5122	S42XLR	BR8ES	5422
B44S	BP5S	3011	FR3LM	ZFR5A-11	5084	R43XLS	BPR6ES	7822	S43XL	B7ES	1111
B45	B4	3210	FR3LS	BKR5E	7938	R44	BR6S	3522	S43XLR	BR7ES	5122
C42-1	B6S	3510	FR3LS6	BKR5E-11	6953	R44CF	BR5HS	3722	S44	B6S	3510
C42CFS	BP6HS	4511	FR3LSK	BKR5E	7938	R44CXL	BR6ES	4922	S44F	B5HS	4210
C42CLTS	BP6EFS	3812	FR4LE	ZFR4F-11	4043	R44CXLS	BPR5ES	7422	S44XL	B6ES	7310

For reference only. Please use application guides for parts selection.

AC DELCO	NGK → STOCK No.	
S45F	B5HS	4210
S46	B4	3210
S81F	A8	1210
S82F	A8	1210
S83F	A7	1110
S83F	AB7	3010
S85F	A6	1010
S85F	AB6	2910
SB41	B7S	3710
SV41XL	BUE	2322
V40FFK	BUHW-2	5626
V40FFM	BUHW	2622
V40FFS	BUH	2422
VB40FFM	BUHXW-1	5526
VR40FFK	BUZHW-2	2173
VR40FFM	BUZHW	2147

ALFA ROMEO	NGK → STOCK No.	
4644 9690	BKR6EKPA	2513
55182623	FR5CP	6368
6056 9086	PGR6A	4984
6056 9957	PFR6B	3500
6057 9903	PFR6B	3500
6059 9495	PMR7A	4529

APRILIA	NGK → STOCK No.	
0297542	DR8EA	7162
0297830	BR10EG	3830
0297921	CR8E	1275
0297942	DCPR9E	2641
0297945	R0045J-10	7400
0897055	BR8ES	5422
2BEN000088	BPR8HS	3725
2BEN000181	CPR8E	7411
8122586	DR7EA	7839
8206870	BR7HS	4122
8206871	BR8HS	4322
8550352	CR7E	4578
8600008	BR9ECM	3252

ASTON MARTIN	NGK → STOCK No.	
021-007-0145	C7HSA	4549
048-007-0149	BPR6ES	7822
07-14641	BPR5EVX	4875
07-20987	BPR6EY	6427
07-21106	BPR7EY	1144
07-21300	BP8EVX	2671
07-22846	BPR8ES	3923
07-26330	BP6ES	7811
07-38800	BCPR7E	1272
07-70920	BCR8ES	5430

AUDI - see VW/AUDI

AUTOLITE	NGK → STOCK No.	
12	BP7FS	3612
13	BP6FS	3512
14	BP6FS	3512
15	BP5FS	3412
23	BPR6FS	2623
24	BPR6FS	2623
25	BPR5FS	2423
26	BPR4FS-15	2727
27	BPR4FS-15	2727
34	AP6FS	2710
43	APR6FS	2922
44	APR6FS	2922
45	APR5FS	3122
46	APR5FS	3122
52	BP7ES	2412
53	BP6ES	7811
54	BP6ES	7811
55	BP5ES	6511
56	BP5ES	6511

AUTOLITE	NGK → STOCK No.	
62	BP7ES	2412
63	BPR6ES	7822
64	BPR6ES	7822
65	BPR5ES	7422
66	BPR5ES	7422
67	BPR4ES	7222
75	BP5S	3011
76	BP5S	3011
77	BP4	2911
85	BP5S	3011
86	BP4	2911
87	BP4	2911
94	BP7EFS	3526
102	BP7EFS	3526
103	BPR6EFS	3623
104	BPR6EFS	3623
105	BPR5EFS	2223
106	BPR5EFS	2223
115	A6FS	2210
117	A6FS	2210
135	B7FS	3027
143	BR6FS	4323
144	BR6FS	4323
145	BR6FS	4323
146	BR5FS	4123
147	BR5FS	4123
166	APR5FS	3122
175	BP5S	3011
203	BPR6FS	2623
215	B6L	3212
216	B6L	3212
217	B4L	3112
218	B4L	3112
235	BM6A	5921
245	BMR6A	7421
253	BM7A	6521
254	BM6A	5921
255	BM6A	5921
258	BM4A	5628
273	BP6HS	4511
274	BP6HS	4511
275	BP5HS	4111
276	BP5HS	4111
283	BPR7HS	6422
284	BPR6HS	7022
292	B8S	3810
294	B6S	3510
295	B4	3210
297	B4	3210
298	B2	3110
302	BR6S	3522
303	BR6S	3522
304	BR6S	3522
306	B4	3210
308	B2	3110
312	B8S	3810
313	B7S	3710
314	B6S	3510
315	B6S	3510
316	B6S	3510
317	B4	3210
318	B2	3110
353	B8S	3810
354	B6S	3510
355	B6S	3510
356	B4	3210
357	B4	3210
358	B2	3110
363	BR6S	3522
372	A8	1210
373	A7	1110
373	AB7	3010
374	A7	1110
374	AB7	3010

AUTOLITE	NGK → STOCK No.	
375	A6	1010
375	AB6	2910
376	A6	1010
376	AB6	2910
377	A6	1010
377	AB6	2910
378	A6	1010
378	AB6	2910
379	AB2	3020
386	A6	1010
386	AB6	2910
393	B7ES	1111
394	B6ES	7310
395	B5ES	6410
396	B5ES	6410
397	B5ES	6410
398	B4ES	4129
402	BR8ES	5422
403	BR6ES	4922
404	BR6ES	4922
405	BR5ES	4722
406	BR5ES	4722
411	B9HS	5810
413	B7HS	5110
414	B6HS	4510
415	B5HS	4210
416	B5HS	4210
417	B4H	4110
424	B6HS	4510
425	BR5HS	3722
426	BR5HS	3722
436	B6L	3212
437	B4L	3112
456	B4LM	3410
458	B2LM	1147
483	BR7EFS	1094
494	B6L	3212
495	B6L	3212
497	B4L	3112
517	BP4HS	3611
536	B4H	4110
664	BPR6FS	2623
665	BPR5FS-15	3124
666	BPR4FS-15	2727
667	BPR4FS-15	2727
687	BR5FS-15	2224
723	BPR6FS	2623
724	BPR6FS	2623
725	BPR5FS-11	2924
726	BPR4FS	1127
727	BPR4FS-11	2527
744	APR5FS	3122
746	APR5FS	3122
747	APR5FS	3122
764	BPR6EFS	3623
765	BPR5EFS	2223
766	BPR5EFS	2223
865	BPR5EFS	2223
915	ZGR5C	6334
925	ZGR5C	6334
935	BPR5ES	7422
945	BPR5ES	7422
996	B6L	3212
2413	B10EGP	5224
2414	B10EG	3630
2415	B9EG	3530
2416	B8EG	3430
2417	B7ECS	2528
2585	BPR5ES	7422
2593	B9ES	2611
2594	B9ES	2611
2612	B9ES	2611
2613	B9ES	2611
2614	B8ES	2411

AUTOLITE	NGK → STOCK No.	
2615	B7ES	1111
2616	B6ES	7310
2634	B9HS-10	3626
2635	B8HS	5510
2636	B7HS	5110
2652	B9HS-10	3626
2653	B7HS	5110
2654	B7HS	5110
2655	B6HS	4510
2656	B5HS	4210
2675	B6L	3212
2676	B6L	3212
2695	A8	1210
2696	A7	1110
2696	AB7	3010
2697	A6	1010
2697	AB6	2910
2715	D8HA	7112
2716	D6HA	6512
2735	D6HA	6512
2755	D8EA	2120
2772	A8	1210
2775	A6	1010
2775	AB6	2910
2794	C8HSA	6821
2795	C7HSA	4629
2796	C6HSA	3228
2852	BUH	2422
2872	BUHW	2622
2892	BUHX	2522
2932	BUE	2322
2954	BM7F	6421
2956	BM6F	6221
2974	BPM7A	7321
2976	BPMR7A	4626
3013	B7S	3710
3014	B6S	3510
3035	A6	1010
3035	AB6	2910
3036	BPR4FS-15	2727
3055	A6FS	2210
3074	G2Z	3320
3075	G2Z	3320
3116	A6	1010
3116	AB6	2910
3203	BPR6ES	7822
3204	BPR6ES	7822
3205	BPR5ES	7422
3206	BPR5ES	7422
3207	BPR5ES	7422
3225	BP5S	3011
3226	BP5S	3011
3227	BP5S	3011
3243	BPR6EFS	3623
3244	BPR6EFS	3623
3245	BPR5EFS	2223
3246	BPR5EFS	2223
3264	B7FS	3027
3265	BR6FS	4323
3266	BR5FS	4123
3267	BR5FS	4123
3286	APR6FS	2922
3303	BPR6FS	2623
3325	B6L	3212
3327	B4L	3112
3345	BMR7A	4226
3364	BPR6HS	7022
3382	BR6S	3522
3383	BR6S	3522
3384	BR6S	3522
3386	BR6S	3522
3388	BR6S	3522
3423	B8S	3810
3426	BR6S	3522

BERU	NGK → STOCK No.
225/14/5	B7S 3710
225/14/5AMX	BPM7A 7321
225/14/UK4	BL-6H 6921
225/14A	BP7HS 5111
225/18	A7 1110
225/18	AB7 3010
225/18S	A7 1110
225/18S	AB7 3010
230/14/3A	BP7ES 2412
235/14/3P	BP7ES 2412
240/14	B7HS 5110
240/14/3	B7ES 1111
240/14A	BP7HS 5111
240/14S	B8HVX 2634
240/18	A7 1110
240/18	AB7 3010
260/14	B8HS 5510
260/14/3	B8ES 2411
260/14S	B8HVX 2634
260/18	A8 1210
265/14/3P	B8EVX 7051
280/14	B8HS 5510
280/14/3S	B8EVX 7051
280/14/3Z	B9ES 2611
280/14Z	B9HS 5810
310/14/3Z	B9EVX 7254
95/14	B4H 4110
95/14/3	B4ES 4129
95/14/5	B4 3210
95/14/5A	BP4 2911
95/14A	BP4HS 3611
95/18	A6 1010
95/18	AB6 2910
D 215/14/3 (14/5/C)	B7ES 1111
D175/14	B6HS 4510
D175/14/3	B6ES 7310
D200/14/3A	BP6ES 7811
D215/14/3	BP6ES 7811
D230/14/3A	BP7ES 2412
RS35	BP6EVX 5832
RS37	BP7EVX 7270
RS39	BP7EVX 7270
Z 1	BP5ES 6511
Z 2	BP5ET 2287
Z 3	ZGR5A 5839
Z 4	ZFR5F 5165
Z 5	BCP5ES 7496
Z 6	BP5EFS 3712
Z 7	BP5EFS 3712
Z 8	BPR5ES 7422
Z 9	BPR5ES-11 4424
Z 10	BP6HS 4511
Z 11	BP6ES 7811
Z 12	BP6ET 1263
Z 13	BKR6E 6962
Z 14	BKR6EK 2288
Z 15	BKR6E 6962
Z 16	BCPR6ES-11 7121
Z 17	BP6EFS 3812
Z 18	BP6EFS 3812
Z 19	BPR6HS 7022
Z 20	BPR6ES 7822
Z 21	BPR6ES-11 4824
Z 22	BP6ES 7811
Z 23	BKR6E 6962
Z 24	BKR6E 6962
Z 25	BP6EFS 3812
Z 26	BPR6EFS 3623
Z 27	BPR6ES 7822
Z 28	BPR6ES-11 4824
Z 29	BCP7ES 5030
Z 30	BCPR7ES 3330
Z 31	BP7EFS 3526
Z 32	AP6FS 2710

BERU	NGK → STOCK No.
Z 33	AP6FS 2710
Z 35	D7EA 7912
Z 36	D7EA 7912
Z 37	B9HS 5810
Z 38	B9ES 2611
Z 39	B8HS 5510
Z 40	B7HS 5110
Z 41	BP7HS 5111
Z 42	BP7ES 2412
Z 43	BP7ES 2412
Z 44	BP6ET 1263
Z 45	BCPR7ET 2164
Z 46	BP7EFS 3526
Z 47	BPR7ES 2023
Z 48	BP6HS 4511
Z 49	BPR6FS 2623
Z 50	BP6ESZ 7639
Z 51	BP6ET 1263
Z 52	BCP6ET 4563
Z 53	BCP6ET 4563
Z 54	BCP6ES 4930
Z 55	BP6EFS 3812
Z 56	BP6EFS 3812
Z 57	B6HS 4510
Z 58	B6ES 7310
Z 59	BR6ES 4922
Z 60	BCPR7ET 2164
Z 61	BP6ESZ 7639
Z 62	BP6ESZ 7639
Z 63	BCP6ES 4930
Z 64	BCP6ES 4930
Z 66	BP6EFS 3812
Z 68	B5HS 4210
Z 71	BCP5ES 7496
Z 72	BCPR5ES 6130
Z 73	BCPR5ES-11 3524
Z 74	BKR5EK 7956
Z 75	BUR5ET 3377
Z 76	BP5ES 6511
Z 78	BP5ET 2287
Z 79	BCP5ES 7496
Z 80	BP5EFS 3712
Z 81	BP5EFS 3712
Z 82	BPR5ES 7422
Z 83	B4LM 3410
Z 84	BR4LM 4133
Z 85	B6HS 4510
Z 86	A7 1110
Z 86	AB7 3010
Z 87	A7 1110
Z 87	AB7 3010
Z 88	A6 1010
Z 88	AB6 2910
Z 89	BKUR6ET 6437
Z 90	BKUR6ET-10 2397
Z 91	BUR6ET 3172
Z 92	BUR5ET 3377
Z 93	BUR5ET-10 7264
Z 94	BPR5EKU 5685
Z 95	BPR6EFS 3623
Z 97	PTR5A-10 5055
Z 99	BCPR6ES-11 7121
Z 100	BKR6ES 3783
Z 101	BKR6EK 2288
Z 103	BP7ES 2412
Z 104	BP6ES 7811
Z 105	BKR6E 6962
Z 107	BP4 2911
Z 112	B4 3210
Z 144	BUR6EFSZ 6837
Z 145	BKR6EKUB 3584
Z 149	BCPR6EP-11 3350
Z 150	BCPR6EP-11 3350
Z 151	BKR6EP-8 2215

BERU	NGK → STOCK No.
Z 152	BCRE527Y 2074
Z 153	BKR5EY 7390
Z 154	BKR5EYA 2087
Z 155	BKR6EY 3696
Z 156	BKR6EYA 2249
Z 157	BKR6EYA-11 4073
Z 158	ZFR6F-11 4291

BM3 (Bulgaria)	NGK → STOCK No.
L15Y	BP6ES 7811
N15	B7HS 5110
N15Y	BP6HS 4511
N17	B6HS 4510

BM3/VMZ	NGK → STOCK No.
L15Y	BP6ES 7811
N15	B7HS 5110
N15Y	BP6HS 4511
N17	B6HS 4510

BMW	NGK → STOCK No.
12 12 0 030 548	BKR6EQUP 3199
12 12 0 031 708	BKR7EQUP 4285
12 12 0 032 134	IZFR6H11 4294
12 12 0 032 135	IZFR6H11 4294
12 12 0 032 136	BKR6EQU 6002
12 12 0 032 137	ILZFR6D11 1208
12 12 0 032 273	LKR8AP 4471
12 12 0 141 871	BKR6EQUP 3199
12 12 1 435 955	BKR6EQUP 3199
12 12 2 343 144	D8EA 2120
12 12 7 653 439	CR8EB 7784
12 12 7 653 771	BKR7EKC 7354
12 12 7 681 415	DCPR8EKC 7168
12 12 9 061 870	ZFR5F 5165
12 12 9 063 428	BKR6EK 2288
12 12 9 064 617	BKR6EK 2288
12 12 9 064 619	BKR6EK 2288
12 12 9 064 656	BKR6EK 2288
12 12 9 065 366	BKR6EK 2288
12 12 9 069 048	PKR7A 3641
12 12 9 071 003	BKR6EQUP 3199
13 12 0 032 134	IZFR6H11 4294
7 650 676	BKR6EKC 2848
7 653 771	BKR6EKC 2848

BONON - see CHINESE BRANDS

BOSCH	NGK → STOCK No.
+1	BPR6ES 7822
+2	BUR6ET 3172
+3	BPR5ES 7422
+4	BUR5ET 3377
+5	BPR6EFS 3623
+6	BKR5E 7938
+7	BKR6EKC 2848
+8	BKR6E 6962
+9	BKR5EK 7956
+10	BPR6HS 7022
+11	BCPR6ES-11 7121
+12	BPR6ES 7822
+13	BKR6E 6962
+14	BPR5EFS 2223
+15	BPR7ES 2023
+16	BPR5ES 7422
+17	PTR5A-10 5055
+18	BPR6EFS 3623
+19	BKR5E-11 6953
+20	BPR5HS 6222
+21	BPR6ES-11 4824
+22	BPR5ES-11 4424
+23	BKR6EKUB 3584
+24	PFR6B 3500
0 241 235 715	PZFR5D-11 7968

BOSCH	NGK → STOCK No.
0 241 235 730	ZFR5P-G 6893
0 242 129 503	LZKAR7A 6799
0 242 229 699	ZFR5F 5165
0 242 235 642	BKR6EKUB 3584
D10BC	APR5FS 3122
D6B	AP6FS 2710
D6BC	AP6FS 2710
D6BP	AP6FS 2710
D7A	A6FS 2210
D7AC	A6FS 2210
D7B	AP6FS 2710
D7BC	AP6FS 2710
D7BP	AP6FS 2710
D8BC	APR5FS 3122
D9BC	APR5FS 3122
DR10B	APR5FS 3122
DR10BC	APR5FS 3122
DR6BC	APR6FS 2922
DR6BP	APR6FS 2922
DR7BC	APR6FS 2922
DR7BP	APR6FS 2922
DR8B	APR5FS 3122
DR8BC	APR5FS 3122
DR8BP	APR5FS 3122
DR9B	APR5FS 3122
DR9BC	APR5FS 3122
F04DAR	BKR6EK 2288
F5DC	BCP7ES 5030
F5DP	BCP7ES 5030
F5DPOR	PFR7B 4853
F5DTC	BCP7ET 2078
F6DC	BCP6ES 4930
F6DCO	BCP6ES 4930
F6DCOR	BKR6E 6962
F6DCX	BCPR6ES-11 7121
F6DP	BCP6ES 4930
F6DPOR	PFR6Q 6458
F6DSR	BKR6EVX 3539
F6DTC	BCP6ET 4563
F6KPP332S	PFR6Q 6458
F6LTCR	BKUR7ET 7873
F7DC	BCP6ES 4930
F7DCO	BCP6ES 4930
F7DCOR	BKR6E 6962
F7DP	BCP6ES 4930
F7DPER	IFR6D10 5344
F7DTC	BCP6ET 4563
F7HER02	ZFR6T-11G 5960
F7HER2	ZFR5P-G 6893
F7HPP22	PZFR5D-11 7968
F7HPPRX	PZFR5D-11 7968
F7KTCR	BKUR6ET 6437
F7LCOR2	ZFR6F-11 4291
F7LCR	ZFR6A-11 1041
F7LDCR	BKR6EK 2288
F7LTCR	BKUR6ET-10 2397
F8DC	BCP5ES 7496
F8DCO	BCP5ES 7496
F8DCOR	BCPR5ES 6130
F8DC4	BCP5ES 7496
F8DCX	BCPR5ES-11 3524
F8DPER	PFR5G-11 2647
F8KTCR	BKUR5ET 2789
F8LCR	ZFR5F 5165
F8LCR2	ZFR5F 5165
F8LDCR	BKR6EK 2288
F9LCR	ZFR4F-11 4043
FGR5KQEO	BKR7EQUP 4285
FGR6HQEO	ZFR6S-Q 6449
FGR6KQC	BKR6EQUP 3199
FGR7DQE	BKR6EKUB 3584
FGR7DQE+	BKR6EKUB 3584
FGR7DQEO	BKR6EKUB 3584
FGR7DQP	BKR6EQUP 3199

BOSCH	NGK → STOCK No.	BOSCH	NGK → STOCK No.	BOSCH	NGK → STOCK No.	BOSCH	NGK → STOCK No.
FGR7KQC	BKR6EQUP 3199	FR8DS	BKR5EVX 2546	HR8B	BPR5FS 2423	MA145TR7	APR5FS 3122
FGR7KQE	BKR6EQUP 3199	FR8DX	BKR5E-11 6953	HR8BC	BPR5FS 2423	MA175T1	A6FS 2210
FGR8KQEO	BKR5EQUB 1567	FR8HDC	BKR5EKB-11 3967	HR8BCY	BPR5FS-15 3124	MA175T7	AP6FS 2710
FLR8LDCU	BKR5EK 7956	FR8HP	ZFR5F-11 2262	HR8BP	BPR5FS 2423	MA200T7	AP6FS 2710
FLR8LDCU+	BKR5EK 7956	FR8KCU	BKR5EYA-11 2526	HR8BPX	BPR5FS-11 2924	UR2AS	CR8HS 7423
FLR8LDU+	BKR5EK 7956	FR8KTCR	BKUR5ET 2789	HR8BPY	BPR5FS-15 3124	UR3AS	CR7HS 7223
F03DAR	BKR6EK 2288	FR8LCX	ZFR6F-11 4291	HR8BY	BPR5FS-15 3124	UR4AS	CR6HS 7023
FQR8DE	BKR6EZB 4293	FR8LDC	BKR5EK 7956	HR8D+	BPR5EFS 2223	USR7AC	CMR6H 3365
FQR8LE2	ZFR5F 5165	FR8ME	LF5B 7113	HR8DC+	BPR5EFS 2223	VR8SE	LZKAR7A 6799
FQR8LEU2	ZFR5F 5165	FR8SEO	LF6B 6677	HR8MEV	TR5B-13 4559	VR8SEW	LZKAR7A 6799
FR5DC	BCPR7ES 3330	FR8SPP332	PLFR5A-11 6240	HR9A	BR5FS 4123	W06AS	B10HVX 2940
FR5DC+	BCPR7ES 3330	FR9HC	ZFR4F-11 4043	HR9AC	BR5FS 4123	W06CS	B11EGV 5831
FR5DCX	BCPR7ES-11 1095	H10BC	BPR4FS 1127	HR9ACY	BR5FS-15 2224	W07AS	B10HVX 2940
FR5DP	BCPR7ES 3330	H2CS	B9EFS 1085	HR9AP	BR5FS 4123	W07CS	B10EGV 5927
FR5DTC	BCPR7ET 2164	H3CS	B8EFS 1049	HR9APY	BPR5FS-15 2224	W08AS	B9HVX 2254
FR5LDC	BKR7EKC 7354	H5D	BP7EFS 3526	HR9AY	BR5FS-15 2224	W08CS	B10EGV 5927
FR6D+	BKR6ES 3783	H5DC	BP7EFS 3526	HR9B	BPR4FS 1127	W10A	B4H 4110
FR6DC	BKR6E 6962	H5DCO	BP7EFS 3526	HR9BC	BPR4FS 1127	W10AC	B4H 4110
FR6DC+	BKR6E 6962	H5DP	BP7EFS 3526	HR9BCY	BPR4FS-15 2727	W10C	B4ES 4129
FR6DC2	BKR6E 6962	H6B	BP6FS 3512	HR9BPX	BPR4FS-11 2527	W10CC	B4ES 4129
FR6DCX	BCPR6ES-11 7121	H6BC	BP6FS 3512	HR9BPY	BPR4FS-15 2727	W10DC	BPR4ES 7222
FR6DDC	BKR7EKC-N 2095	H6D	BP6EFS 3812	HR9BY	BPR4FS-15 2727	W10E	B4 3210
FR6DP	BKR6EP-8 2215	H6DC	BP6EFS 3812	HR9D	BPR5EFS 2223	W10F	BP4 2911
FR6DP1X	BKR6EP-11 2978	H6DCO	BP6EFS 3812	HR9DC	BPR5EFS 2223	W10FC	BP4 2911
FR6DPP332	PFR6B 3500	H6DP	BP6EFS 3812	HS5E	BM7F 6421	W125T1	B4H 4110
FR6DPX	BCPR6ES-11 7121	H7CC	B6EFS 2042	HS8E	BM6F 6221	W125T2	B4ES 4129
FR6DTC	BCPR6ET 2197	H7CP	B6EFS 2042	M10A	A6 1010	W125T3	B4 3210
FR6DTCW	BCPR6ET 2197	H7D	BP6EFS 3812	M10A	AB6 2910	W125T30	BP5ES 6511
FR6KDC	BKR6EK 2288	H7DC	BP6EFS 3812	M10A0	A6 1010	W125T4	B4H 4110
FR6KPP332S	PFR6Q 6458	H7DCO	BP6EFS 3812	M10A0	AB6 2910	W125TR2	BR5ES 4722
FR6LDC	BKR6EKC 2848	H7DP	BP6EFS 3812	M10AC	A6 1010	W125TR3	BR6S 3522
FR6LTC	BKUR7ET 7873	H8B	BP5FS 3412	M10AC	AB6 2910	W125TR30	BPR5ES 7422
FR6MPP332	ILFR6A 3588	H8BC	BP5FS 3412	M10ACO	A6 1010	W12A	B4H 4110
FR7D+	BKR6ES 3783	H8BP	BP5FS 3412	M10ACO	AB6 2910	W12E	B2 3110
FR7D+X	BKR6E-11 2756	H8DC	BP5EFS 3712	M12B	A6 1010	W145T1	B5HS 4210
FR7DC	BKR6E 6962	H8DCO	BP5EFS 3712	M12B	AB6 2910	W145T1.1	B5HS 4210
FR7DC+	BKR6E 6962	H8DP	BP5EFS 3712	M145T1	A6 1010	W145T2	B5ES 6410
FR7DCO	BKR6E 6962	H9BC	BPR4FS 1127	M145T1	AB6 2910	W145T3	B6S 3510
FR7DC2	BKR6E 6962	H9BCY	BPR4FS-15 2727	M145T5	A6 1010	W145T30	BP5ES 6511
FR7DC9	BKR6E 6962	H9DC	BP5EFS 3712	M145T5	AB6 2910	W145T35	BP5HS 4111
FR7DCX	BCPR6ES-11 7121	H9DCO	BP5EFS 3712	M175T1	A6 1010	W145TR2	BR5ES 4722
FR7DCX+	BCPR6ES-11 7121	H9HP	BP5EFS 3712	M175T1	AB6 2910	W145TR3	BR6S 3522
FR7DE	BKR6EZ 4619	HLR8STEX	LTR6B-10T 5948	M225T1	A7 1110	W145TR30	BPR5ES 7422
FR7DP	BKR6E 6962	HR10A	BR5FS 4123	M225T1	AB7 3010	W175T1	B6HS 4510
FR7DP1X	PFR6B-11 4014	HR10AC	BR5FS 4123	M240T1	A7 1110	W175T2	B6ES 7310
FR7DPP+	PFR6B 3500	HR10ACY	BR5FS-15 2224	M240T1	AB7 3010	W175T3	B6S 3510
FR7DPP10	BKR6EVX 3539	HR10AY	BR5FS-15 2224	M280T1	A8 1210	W175T30	BP6ES 7811
FR7DPP22U	PFR6N-11 3546	HR10B	BPR4FS 1127	M45T1	A6 1010	W175T35	BP6HS 4511
FR7DPP33	PFR6Q 6458	HR10BC	BPR4FS 1127	M45T1	AB6 2910	W175TR1	BR6HS 3922
FR7DPX	BKR6E-11 2756	HR10BCX	BPR4FS-11 2527	M4A	A7 1110	W175TR30	BPR6ES 7822
FR7DTC	BCPR6ET 2197	HR10BCY	BPR4FS-15 2727	M4A	AB7 3010	W175Z1	B6HS 4510
FR7HPP332	PZFR5N-11T 7742	HR10BX	BPR4FS-11 2527	M4A1	A8 1210	W200T30	BP6ES 7811
FR7KDC	BKR6EKC 2848	HR10BY	BPR4FS-15 2727	M4A2	A7 1110	W200T35	BP6HS 4511
FR7KPP332	IZFR6H11 4294	HR6B	BPR6FS 2623	M4A2	AB7 3010	W200TR30	BPR6ES 7822
FR7KTC	BKUR6ET-10 2397	HR6BC	BPR6FS 2623	M4AC	A7 1110	W215T30	BP6ES 7811
FR7LC2	BKR6E 6962	HR6BP	BPR6FS 2623	M4AC	AB7 3010	W225T1	B7HS 5110
FR7LCX	ZFR6F-11 4291	HR6D	BPR6EFS 3623	M5A	A7 1110	W225T2	B7ES 1111
FR7LD+	BKR6EK 2288	HR6D+	BPR6EFS 3623	M5A	AB7 3010	W225T3	B7S 3710
FR7LDC	BKR6EKC 2848	HR6DC	BPR6EFS 3623	M5AC	A7 1110	W225T35	BP7HS 5111
FR7LDC+	BKR6EKC 2848	HR6DC+	BPR6EFS 3623	M5AC	AB7 3010	W225TR30	BPR7ES 2023
FR7ME	LF6B 6677	HR6DP	BPR6EFS 3623	M7A	A6 1010	W230T30	BP7ES 2412
FR7MPP10	PLFR6A-11 7654	HR6DS	BPR6EFS 3623	M7A	AB6 2910	W240M1	B8HS 5510
FR7NPP33	ILZFR6C-K 6645	HR7D+	BPR6EFS 3623	M7AC	A7 1110	W240MZ1	B8HS 5510
FR7SE	LF6C-11 5788	HR7DC	BPR6EFS 3623	M7AC	AB7 3010	W240T1	B8HS 5510
FR8D+	BKR5E 7938	HR7DC+	BPR6EFS 3623	M8A	A6 1010	W240T2	B8ES 2411
FR8D+X	BKR5E-11 6953	HR7MPP	PTR5A-10 5055	M8A	AB6 2910	W240T3	B7S 3710
FR8DC	BKR5E 7938	HR7MPP+	PTR5A-10 5055	M8A0	A6 1010	W250P21	BP7ES 2412
FR8DC+	BKR5E 7938	HR7MPP+V	PTR5A-10 5055	M8A0	AB6 2910	W250T1	B8HS 5510
FR8DCO	BKR5E 7938	HR8A	BR5FS 4123	M8AC	A6 1010	W250T2	B8ES 2411
FR8DCX	BKR5E-11 6953	HR8AC	BR5FS 4123	M8AC	AB6 2910	W255T30	BP7ES 2412
FR8DCX+	BKR5E-11 6953	HR8ACY	BR5FS-15 2224	M95T1	A6 1010	W260M1	B8HS 5510
FR8DE	BKR5EZ 7642	HR8AP	BR5FS 4123	M95T1	AB6 2910	W260MZ1	B8HS 5510
FR8DPP33	PFR5G-11 2647	HR8APY	BR5FS-15 2224	M95T5	A6 1010	W260MZ2	B9ES 2611
FR8DPX	BKR5E-11 6953	HR8AY	BR5FS-15 2224	M95T5	AB6 2910	W260S1S	B8HVX 2634

BOSCH	NGK → STOCK No.		BOSCH	NGK → STOCK No.		BOSCH	NGK → STOCK No.		BOSCH	NGK → STOCK No.	
W260S2S	B8EVX	7051	W6B	BP6HS	4511	W9DP	BP5ES	6511	WR7DP	BPR6EVX	6764
W260T1	B8HS	5510	W6BC	BP6HS	4511	W9DTC	BP5ET	2287	WR7DS	BPR6EIX	6637
W260T2	B9ES	2611	W6BP	BP6HS	4511	W9E	B4	3210	WR7LTC	BUR6ET	3172
W260T20	B8ES	2411	W6D	BP6ES	7811	W9EO	B4LM	3410	WR7LTC+	BUR6ET	3172
W275T1	B8HS	5510	W6D1	BP6ES	7811	W9EC	B4	3210	WR8AC	BR5HS	3722
W275T2	B9ES	2611	W6DC	BP6ES	7811	W9ECO	B4LM	3410	WR8B+	BPR5HS	6222
W280MZ1	B8HS	5510	W6DC	BP6ES	7811	W9F	BP5S	3011	WR8BC+	BPR5HS	6222
W280MZ2	B9ES	2611	W6DCO	BP6ES	7811	W9FC	BP5S	3011	WR8C	BR5ES	4722
W280S1S	B9HVX	2254	W6DCO	BP6ESZ	7639	W9LC	ZGR5A	5839	WR8CC	BR5ES	4722
W280S2S	B9EVX	7254	W6DP	BP6EVX	5832	WA125TR30	BPR5EFS	2223	WR8CP	BR5ES	4722
W280T30	BP8ES	2912	W6DPO	BP6EVX	5832	WA200T30	BP6EFS	3812	WR8D	BPR5ES	7422
W2A	B9HS	5810	W6DPX	BP6EVX (1,1)	5832	WA200TR30	BPR6EFS	3623	WR8D+	BPR5ES	7422
W2AC	B9HS	5810	W6DTC	BP6ET	1263	WA225T30	BP7EFS	3526	WR8DC	BPR5ES	7422
W2AP	B9HVX	2254	W7A	B6HS	4510	WAK145T3	BM6F	6221	WR8DC+	BPR5ES	7422
W2AS	B9HVX	2254	W7AO	B6HS	4510	WAK225T3	BM7F	6421	WR8DCO	BPR5ES	7422
W2CS	B10EVX	7335	W7AC	B6HS	4510	WEA	BUH	2422	WR8DC4	BPR6ES	7822
W2D	BP9ES	7526	W7AP	B6HS	4510	WEC	BUE	2322	WR8DCX	BPR5ES-11	4424
W300T1	B9HS	5810	W7B	BP6HS	4511	WET1	BUH	2422	WR8DCX+	BPR5ES-11	4424
W300T30	BP9ES	7526	W7BC	BP6HS	4511	WET2	BUE	2322	WR8DP	BPR5ES	7422
W310S1S	B9HVX	2254	W7BP	BP6HS	4511	WKA145T3	BM6A	5921	WR8DPX	BPR5ES-11	4424
W310S2S	B10EVX	7335	W7C	B6ES	7310	WKA145T6	BPM6A	7021	WR8E	BR6S	3522
W3A	B8HS	5510	W7CC	B6ES	7310	WKA175T3	BM6A	5921	WR8EC	BR6S	3522
W3A0	B8HS	5510	W7CCO	B6ES	7310	WKA175T6	BPM6A	7021	WR8EP	BR6S	3522
W3AC	B8HS	5510	W7CP	B6ES	7310	WKA200TR6	BPMR6A	6726	WR8F	BP5S	3011
W3AP	B8HS	5510	W7D	BP6ES	7811	WKA225T3	BM7A	6521	WR8FC	BP5S	3011
W3AS	B8HVX	2634	W7DO	BP6ES	7811	WKA225T6	BPM7A	7321	WR8FP	BP5S	3011
W3C	B9ES	2611	W7DO	BP6ES	7811	W06CS	B11EGV	5831	WR8HP	ZGR5C	6334
W3CO	B9ES	2611	W7DC	BP6ES	7811	WR10A	BR4HS	3322	WR8LTC+	BUR5ET	3377
W3CC	B9ES	2611	W7DCO	BP6ESZ	7639	WR10AC	BR4HS	3322	WR9A0	BR5HS	3722
W3CP	B9ES	2611	W7DCR	BPR6ES	7822	WR10DC	BPR4ES	7222	WR9C	BR5ES	4722
W3CS	B9EVX	7254	W7DCX	BPR6ES-11	4824	WR10E	BR6S	3522	WR9CC	BR5ES	4722
W3D	BP8ES	2912	W7DP	BP6ES	7811	WR10F	BP4	2911	WR9D	BPR5ES	7422
W3DP	BP8EVX	2671	W7DTC	BP6ET	1263	WR10FC	BP4	2911	WR9D+	BPR5ES	7422
W3DPO	BP8EVX	2671	W7E	B6S	3510	WR11EO	BR4LM	4133	WR9DC	BPR5ES	7422
W3DP2	BP8ES	2912	W7EC	B6S	3510	WR3CC	BR9ES	5722	WR9DC+	BPR5ES	7422
W45T1	B4H	4110	W7EP	B6S	3510	WR4AC	BR8HS	4322	WR9DP	BPR5ES	7422
W4A	B8HS	5510	W7LTCR	BUR6ET	3172	WR4CC	BR8ES	5422	WR9DPX	BPR5ES-11	4424
W4A1	B8HS	5510	W8A	B5HS	4210	WR4CP	BR8EIX	5044	WR9E	BR6S	3522
W4A2	B8HS	5510	W8A0	B5HS	4210	WR5A	BR7HS	4122	WR9EO	BR6S	3522
W4A5	B8HS	5510	W8AC	B5HS	4210	WR5AC	BR7HS	4122	WR9EC	BR6S	3522
W4AC	B8HS	5510	W8AP	B5HS	4210	WR5BC	BPR7HS	6422	WR9ECO	BM6	2027
W4AP	B8HS	5510	W8B	BP5HS	4111	WR5CC	BR7ES	5122	WR9F	BP5S	3011
W4AS	B8HVX	2634	W8BC	BP5HS	4111	WR5CP	BR7ES	5122	WR9FC	BP5S	3011
W4C	B8ES	2411	W8BP	BP5HS	4111	WR5D	BPR7ES	2023	WR9FP	BP5S	3011
W4C1	B8ES	2411	W8C	B5ES	6410	WR5D+	BPR7ES	2023	WR9HC	ZGR5C	6334
W4C2	B7ES	1111	W8CO	B5ES	6410	WR5DC	BPR7ES	2023	WR9HP	ZGR5C	6334
W4C3	B7HS	5110	W8CC	B5ES	6410	WR5DC+	BPR7ES	2023	WR9LE	ZGR5A	5839
W4CC	B8ES	2411	W8CCX	B5ES	6410	WR5DP	BPR7ES	2023	WR9LS	ZGR5A	5839
W4CP	B8EVX	7051	W8CP	B5ES	6410	WR5DS	BPR7EIX	4055	WS5E	BM7A	6521
W4CS	B8EVX	7051	W8D	BP5ES	6511	WR6D	BPR6ES	7822	WS5F	BPM7A	7321
W4DP	BP7EVX	7270	W8DC	BP5ES	6511	WR6D+	BPR6ES	7822	WS7E	BM6A	5921
W4DPO	BP7EVX	7270	W8DCO	BP5ES	6511	WR6DC	BPR6ES	7822	WS7F	BPM6A	7021
W4E2	B7S	3710	W8DP	BP5ES	6511	WR6DC+	BPR6ES	7822	WS8E	BM6A	5921
W5A	B7HS	5110	W8DTC	BP5ET	2287	WR6DCX	BPR6ES-11	4824	WS8F	BPM6A	7021
W5AC	B7HS	5110	W8E	B6S	3510	WR6DP	BPR6ES	7822	WSR5F	BPMR7A	4626
W5AP	B7HS	5110	W8EC	B6S	3510	WR6DPX	BPR6ES-11	4824	WSR6F	BPMR6A	6726
W5AS	B7HVX	7836	W8F	BP5S	3011	WR6DS	BPR6EIX	6637	WSR8E	BMR6A	7421
W5B	BP7HS	5111	W8FC	BP5S	3011	WR6DTC	BP6ET	1263	WSR8F	BPMR6A	6726
W5BC	BP7HS	5111	W8LCR	ZGR5A	5839	WR7A	BR6HS	3922	WSR9E	BMR4A	5728
W5BP	BP7HS	5111	W8LDCR	BUR6ET	3172	WR7AC	BR6HS	3922	X3CPO	D9EA	2420
W5C	B7ES	1111	W8LPR	ZGR5A	5839	WR7B	BPR6HS	7022	X4CS	D8EA	2120
W5CC	B7ES	1111	W8LTCR	BUR5ET	3377	WR7B+	BPR6HS	7022	X5DC	D7EA	7912
W5CP	B7ES	1111	W95T1	B4H	4110	WR7BC	BPR6HS	7022	XR2AS	DR8HS	5123
W5CS	B7EVX	6934	W95T2	B4ES	4129	WR7BC+	BPR6HS	7022	XR2CS	DR8ES	5423
W5D	BP7ES	2412	W95T3	B4	3210	WR7BP	BPR6HS	7022	XR4AS	DR8HS	5123
W5D1	BP7ES	2412	W95T6	BP4	2911	WR7C	BR6ES	4922	XR4CS	DR8ES	5423
W5DC	BP7ES	2412	W9A	B4H	4110	WR7CC	BR6ES	4922	XR5DC	DR7EA	7839
W5DCO	BP7ES	2412	W9A0	B4H	4110	WR7CP	BR6ES	4922	Y7MPP33	PLKR7A	4288
W5DP	BP7ES	2412	W9AC	B5HS	4210	WR7D	BPR6ES	7822	YR6LDE	DCPR8EKC	7168
W5DPO	BP7EVX	7270	W9ACO	B5HS	4210	WR7D+	BPR6ES	7822	YR7DE	DCPR8E-N	5692
W5DTC	BP6ET	1263	W9C	B4ES	4129	WR7DC	BPR6ES	7822	YR7LPP332W	IZKR7B	7563
W5E	B7S	3710	W9CC	B4ES	4129	WR7DC+	BPR6ES	7822			
W5EC	B7S	3710	W9D	BP5ES	6511	WR7DCX	BPR6ES-11	4824			
W5EP	B7S	3710	W9DC	BP5ES	6511	WR7DCX+	BPR6ES-11	4824			

BRIGGS & STRATTON NGK → STOCK No.		
BS19LM	B2LM	1147
BS19LMR	BR2LM	5798
BRISK NGK → STOCK No.		
B14YC	DP8EA-9	9521
D12YC	BCP7ES	5030
D14Y	BKR6E	6962
D14YC	BCP7ES	5030
D15Y	BKR6E	6962
D15YC	BCP6ES	4930
D17Y	BKR5E	7938
D17YC	BCP5ES	7496
DR12YC	BKR7E	6097
DR14YC	BCPR7ES	3330
DR14ZC	ZFR7F-11	2975
DR14ZC-1	BCPR7ES-11	1095
DR15TC	BKUR5ET-10	7553
DR15YC	BKR6E	6962
DR15Z	BKR6E	6962
DR15Z-1	BCPR6ES-11	7121
DR17YC	BCPR5ES	6130
F14YC	AP7FS	2127
F15YC	AP6FS	2710
FR14YC	APR6FS	2922
FR15YC	APR6FS	2922
G12YC	BP7EFS	3526
G14Y	BP7EFS	3526
G14YC	BP7EFS	3526
G15Y	BP6EFS	3812
G15YC	BP6EFS	3812
G17Y	BP5EFS	3712
G17YC	BP5EFS	3712
GR15YC	BPR6EFS	3623
GR17YC	BPR5EFS	2223
J17	B4LM	3410
J19	B2LM	1147
JR17	BR4LM	4133
JR19	BR2LM	5798
K17C	B6S	3510
K17Y	BP5S	3011
K19	B4	3210
L08JW	B10EGV	5927
L08W	B11EGV	5831
L10JW	B8EGV	5627
L12W	B9EVX	7254
L12Y	BP9ES	7526
L12YC	BP9ES	7526
L14	B8ES	2411
L14C	B8ES	2411
L14Y	BP6ES	7811
L14YC	BP7ES	2412
L15	B7ES	1111
L15C	B7ES	1111
L15W	B8EVX	7051
L15Y	BP6ES	7811
L15YC	BP6ES	7811
L17	B6ES	7310
L17C	B6ES	7310
L17W	B7EVX	6934
L17Y	BP5ES	6511
L17YC	BP5ES	6511
L19C	B5ES	6410
LR12YC	BPR8ES	3923
LR12ZC	BPR8ES	3923
LR14TXS	BUR6ET	3172
LR14YC	BPR7ES	2023
LR14ZC	BPR7ES	2023
LR14ZC-1	BPR7ES-11	7226
LR15TXS	BP5ET	2287
LR15YC	BPR6ES	7822
LR15Z	BPR6ES	7822
LR15Z-1	BPR6ES-11	4824
LR17YC	BPR5ES	7422
N08W	B10HVX	2940

BRISK NGK → STOCK No.		
N12W	B9HVX	2254
N12Y	BP8HS	2630
N12YC	BP8HS	2630
N14	B8HS	5510
N14C	B9HS	5810
N14Y	BP6HS	4511
N14YC	BP7HS	5111
N15	B6HS	4510
N15C	B7HS	5110
N15W	B8HVX	2634
N15Y	BP6HS	4511
N15YC	BP6HS	4511
N17	B5HS	4210
N17C	B6HS	4510
N17W	B7HVX	7836
N17Y	BP4HS	3611
N17YC	BP5HS	4111
N19	B5HS	4210
N19C	B5HS	4210
NR12YC	BPR8HS	3725
NR15YC	BPR6HS	7022
P15	BM7A	6521
P15Y	BPM7A	7321
P17	BM6A	5921
P17Y	BPM6A	7021
PR15Y	BPMR7A	4626
PR17	BMR6A	7421
PR17Y	BPMR6A	6726
U15	BM7F	6421
U17	BM6F	6221

CARLTON NGK → STOCK No.		
71010	BM7F	6421
71015	BM6F	6221
71020	BM7A	6521
71025	BPM7A	7321
71030	BM7A	6521
71035	BPM7A	7321
71040	BM6A	5921
71045	BPM6A	7021
71050	B6HS	4510
71055	B5HS	4210
71060	B4	3210
71065	B4H	4110
71070	BPMR6A	6726
C10S	B4H	4110
C7S	B6HS	4510
C8S	B5HS	4210
C9	B4	3210
CA5E	BM7A	6521
CA5Y	BPM7A	7321
CA6	BPMR6A	7626
CA7E	BM7A	6521
CA7Y	BPM7A	7321
CA8E	BM6A	5921
CA8Y	BPM6A	7021
CN6E	BM7F	6421
CN8E	BM6F	6221

CHAMPION NGK → STOCK No.		
4 COM	A7	1110
4 COM	AB7	3010
5 COM	A7	1110
5 COM	AB7	3010
7 COM	A6	1010
7 COM	AB6	2910
8 COM	A6	1010
8 COM	AB6	2910
860	A6FS	2210
A10	D7EA	7912
A26	A6	1010
A26	AB6	2910
A2HC	DPR9EA-9	5329
A5YC	DPR9EA-9	5329

CHAMPION NGK → STOCK No.		
A51R	R2525-10	5281
A55C	R2525-10	5281
A55R	R2525-10	5281
A57C	R2525-10	5281
A57G	R2525-10	5281
A57R	R2525-10	5281
A59C	DCR9EIX	6650
A59G	DCR9EIX	6650
A59GC	DCR9EIX	6650
A6	D8EA	2120
A6G	D8EVX	2850
A6GC	D8EVX	2850
A61	D9EA	2420
A61G	D9EVX	2834
A65	A6	1010
A65	AB6	2910
A8	D7EA	7912
BL11Y	BP5FS	3412
BL13Y	BP5FS	3412
BL4	B7FS	3027
BL5	B7FS	3027
BL7Y	BP7FS	3612
BL9Y	BP6FS	3512
BN12Y	BP5EFS	3712
BN2	B9EFS	1085
BN6Y	BP7EFS	3526
BN7Y	BP6EFS	3812
BN89Y	BP6EFS	3812
BN9Y	BP6EFS	3812
C10YCC	BCP6ES	4930
C11YCC	BCP5ES	7496
C12YCC	BKR5E	7938
C281YC	BCP6ES	4930
C53	R7436-10	4900
C55	R7436-10	4900
C57	R7436-9	4899
C57C	R7436-9	4899
C57YC	R7435-9	4896
C59	R7436-9	4899
C59C	R7436-9	4899
C59YC	R7435-9	4896
C6BYC	BCP7ET	2078
C6BYC4	BCP7ET	2078
C6VPYC	BKR7EVX	3544
C6YCC	BCP7ES	5030
C6YCX	BCP7ES	5030
C61	R7436-8	4898
C61C	R7436-8	4898
C7Y	BCP7ES	5030
C7YC	BCP7ES	5030
C7YCC	BCP7ES	5030
C7YCX	BCP7ES	5030
C9MCC	ZFR5F	5165
C9Y	BCP6ES	4930
C9YC	BCP6ES	4930
C9YCC	BCP6ES	4930
C9YCX	BCP6ES	4930
CJ11	BM6A	5921
CJ14	BM4A	5628
CJ17LM	B4LM	3410
CJ3	BM7A	6521
CJ4	BM7A	6521
CJ6	BM7A	6521
CJ6Y	BPM7A	7321
CJ7Y	BPM7A	7321
CJ8	BM6A	5921
CJ8Y	BPM6A	7021
CJ86	BM6A	5921
D10	AB6	2910
D14	AB6	2910
D16	AB6	2910
D16J	AB6	2910
D21	AB6	2910
D23	A6	1010

CHAMPION NGK → STOCK No.		
D23	AB6	2910
D6	A8	1210
D9	AB6	2910
D9J	AB6	2910
D9JM	A7	1110
D9JM	AB7	3010
DJ6J	BM7F	6421
DJ6Y	BPM7F	1268
DJ7J	BM6F	6221
DJ7Y	BPM6F	5950
DJ8J	BM6F	6221
E82	A7FS	2976
F10	A6FS	2210
F10C	A6FS	2210
F62Y	AP8FS	2227
F7Y	AP7FS	2127
F7YC	AP7FS	2127
F7YCC	AP7FS	2127
F81Y	AP8FS	2227
F82	A8FS	4489
F83Y	AP8FS	2227
F9Y	AP6FS	2710
F9YC	AP6FS	2710
FN507Y	BCP7ES	5030
G1	C9E	7499
G2	C8E	7471
G54V	R0045J-10	7400
G55	C9E	7499
G56R	R0373A-10	9528
G58	C9E	7499
G61	C8E	7471
G63	C8E	7471
H03	B6S	3510
H10	B6L	3212
H10C	B6L	3212
H10J	B6L	3212
H11	B4L	3112
H12	B4L	3112
H8	B6L	3212
H8C	B6L	3212
H8J	B6L	3212
J11	B4	3210
J11J	B4	3210
J11Y	BP5S	3011
J12J	B2C	3110
J12Y	BP5S	3011
J12YC	BP5S	3011
J13Y	BP5S	3011
J14J	B2	3110
J14Y	BP5S	3011
J14YC	BP5S	3011
J17LM	B4LM	3410
J18Y	BP4	2911
J18YC	BP4	2911
J19LM	B2LM	1147
J4	B7S	3710
J4C	B7S	3710
J4J	B7S	3710
J5	B7S	3710
J6	B6S	3510
J6C	B6S	3510
J6J	B6S	3510
J7	B6S	3510
J7J	B6S	3510
J8	B6S	3510
J8C	B6S	3510
J8J	B6S	3510
K11	A6	1010
K11	AB6	2910
K13	A6	1010
K13	AB6	2910
K15J	A6	1010
K15J	AB6	2910
K3G	A8	1210

CHAMPION	NGK → STOCK No.	CHAMPION	NGK → STOCK No.	CHAMPION	NGK → STOCK No.	CHAMPION	NGK → STOCK No.	
K5G	A8	1210	N2C	B9ES	2611	OE005	BKR6E	6962
K7	A8	1210	N2C	B9ES	2611	OE006	BPR6ES	7822
K8	A8	1210	N2G	B9EVX	7254	OE007	BP6HS	4511
K8G	A8	1210	N21	B4ES	4129	OE008	BPR7ES	2023
K9	A7	1110	N279YC	BP7ES	2412	OE009	BP6EFS	3812
K9	AB7	3010	N281YC	BP6ES	7811	OE010	BP7ES	2412
KC8ZMCC	ZFR5P-G	6893	N288	B5ES	6410	OE011	BPR6EFS	3623
KC8ZPYPB4	PZFR5D-11	7968	N3	B8ES	2411	OE012	BP6ET	1263
L10	B6HS	4510	N3C	B8ES	2411	OE013	BKR5E	7938
L10S	B6HS	4510	N3G	B8EVX	7051	OE014	BKR7E	6097
L11S	B7HS	5110	N4	B7ES	1111	OE015	BP5ES	6511
L12Y	BP5HS	4111	N4C	B7ES	1111	OE016	BKR6E	6962
L14	B4H	4110	N4G	B7EVX	6934	OE017	BCP7ES	5030
L15Y	BP4HS	3611	N4YC	BP9ES	7526	OE018	BPR7ES	2023
L19V	BUH	2422	N5	B6ES	7310	OE019	BKR5EK	7956
L20V	BUH	2422	N5C	B6ES	7310	OE020	BPR6EFS	3623
L288	B5HS	4210	N52R	B11EGP	2191	OE021	BCPR6ET	2197
L2G	B9HVX	2254	N54R	B10EGP	5224	OE023	BCP6ES	4930
L3G	B8HVX	2634	N55G	B105EGV	2171	OE024	BCPR6ES-11	7121
L4G	B7HVX	7836	N56R	B105EGP	2077	OE025	BUR6ET	3172
L4J	B7HS	5110	N57G	B105EGV	2171	OE026	BKR6EK	2288
L5	B7HS	5110	N57R	B10EGP	5224	OE027	BUR5ET-10	7264
L55G	B10HVX	2940	N59G	B95EGV	2145	OE028	BP5ET-10	5156
L61Y	BP8HS	2630	N6	B6ES	7310	OE029	PTR5A-10	5055
L64Y	BP7HS	5111	N6BYC	BP6ET	1263	OE030	BKR6EK	2848
L66Y	BP6HS	4511	N6GY	BP8EVX	2671	OE031	PTR5A-10	5055
L6G	B7HVX	7836	N6Y	BP8ES	2912	OE032	BKUR6ET-10	2397
L7J	B6HS	4510	N6YC	BP8ES	2912	OE033	BKR6EZ	4619
L76V	BUHW	2622	N6YCC	BP8ES	2912	OE034	BKR6EZ	4619
L77J	B7HS	5110	N60	B9ES	2611	OE035	LF5B	7113
L77J4	B7HS-10	2129	N60R	B8EGP	2046	OE036	BP6EFS	3812
L77JC	B7HS	5110	N62R	B8EGP	2046	OE037	B6HS	4510
L77JC4	B7HS-10	2129	N63Y	BP9ES	7526	OE038	BP6HS	4511
L77V	BUHW	2622	N64Y	BP8ES	2912	OE039	BCPR6ES-11	7121
L78	B7HS	5110	N65Y	BP7ES	2412	OE040	B9ES	2611
L78C	B7HS	5110	N66Y	BP6ES	7811	OE041	FR5-1	7252
L78V	BUHW-2	5626	N7	B7ES	1111	OE042	BPR5ES	7422
L81	B7HS	5110	N79Y	BP6ES	7811	OE043	BCPR7ES	3330
L81Y	BP7HS	5111	N7BMC	BP6ET	1263	OE044	BP6ET	1263
L82	B6HS	4510	N7BYC	BP6ET	1263	OE045	BPR5ES	7422
L82C	B6HS	4510	N7GY	BP7EVX	7270	OE046	BP7ES	2412
L82Y	BP6HS	4511	N7Y	BP7ES	2412	OE047	BPR6ES-11	4824
L82YC	BP6HS	4511	N7YC	BP7ES	2412	OE048	BPR6ES-11	4824
L82YCC	BP6HS	4511	N7YCC	BP7ES	2412	OE049	BPR5ES-11	4424
L85	B6HS	4510	N7YCX	BP7ES	2412	OE050	BP7EFS	3526
L85Y	BP6HS	4511	N8	B6ES	7310	OE051	BPR5ES	7422
L86	B6HS	4510	N8B	B6ES	7310	OE052	DCPR8E-N	5692
L86C	B6HS	4510	N8GY	BP6EVX	5832	OE053	APR6FS	2922
L86CC	B6HS	4510	N8L	ZGR5C	6334	OE054	APR6FS	2922
L87C	B6HS	4510	N8Y	BP6ES	7811	OE055	BP5ES	6511
L87Y	BP6HS	4511	N80	B10EG	3630	OE056	BKR7E-11	1283
L87YC	BP6HS	4511	N80G	B11EGV	5831	OE057	BCP5ES	7496
L87YCC	BP6HS	4511	N82	B10EG	3630	OE058	BCP7ES	5030
L89CM	BP5HS	4111	N82G	B105EGV	2171	OE059	BP5HS	4111
L9J	B6HS	4510	N84	B9EG	3530	OE060	ZGR5B	7345
L90	B5HS	4210	N84G	B95EGV	2145	OE061	AP7FS	2127
L92Y	BP5HS	4111	N86	B9EG	3530	OE062	BKR6E-11	2756
L92YC	BP5HS	4111	N86G	B9EGV	5827	OE063	BKR6E-11	2756
L95Y	BP4HS	3611	N87	B8EG	3430	OE064	BPR6HS	7022
N10PY	BP6EVX	5832	N87G	B8EGV	5627	OE065	BP5ES	6511
N10Y	BP6ES	7811	N9BMC	BPR5EKU	5685	OE067	BP7EFS	3526
N11Y	BP5ES	6511	N9BYC	BP6ET	1263	OE068	B8ES	2411
N11YC	BP5ES	6511	N9BYC4	BP5ET-10	5156	OE069	BCP6ES	4930
N11YCC	BP5ES	6511	N9Y	BP6ES	7811	OE070	BP6HS	4511
N12Y	BP5ES	6511	N9YC	BP6ES	7811	OE071	BPR6HS	7022
N12YC	BP5ES	6511	N9YCC	BP6ES	7811	OE072	BP5EFS	3712
N12YCC	BP5ES	6511	N9YCX	BP6ES	7811	OE073	DCPR9E	2641
N13L	ZGR5C	6334	NA10	B8ES	2411	OE074	B6ES	7310
N13Y	BP5ES	6511	NA8	B6ES	7310	OE075	BCP7ES	5030
N14LY	ZGR5C	6334	OBL9Y	BPR6FS	2623	OE076	BCP7ET	2078
N14Y	BP5ES	6511	OE001	BP6ES	7811	OE077	BCPR6ET	2197
N19V	BUE	2322	OE002	BKR6E	6962	OE078	B8EVX	7051
N1C	BR10ES	4832	OE003	BCP6ES	4930	OE079	B7ES	1111
N2	B9ES	2611	OE004	BPR6ES	7822	OE080	BKR7E-11	1283
OE081	BKR6E-11	2756						
OE082	BP7EFS	3526						
OE084	BP8ES	2912						
OE085	BKR5EKU	3964						
OE086	BR6HS	3922						
OE087	BP8ES	2912						
OE088	BCPR6ES	2330						
OE089	ZFR6F-11	4291						
OE090	BP7EFS	3526						
OE091	BR9ES	5722						
OE092	CR9E	6263						
OE093	BKR6ES	3783						
OE094	BCPR7ES	3330						
OE095	BP6ET	1263						
OE096	B6HS	4510						
OE098	BR7ES	5122						
OE099	BP5EFS	3712						
OE100	BPR5EKU	5685						
OE101	BPR5ES-11	4424						
OE104	BP6HS	4511						
OE106	BP5ES	6511						
OE107	BPR7ES-11	7226						
OE108	BR8ES	5422						
OE109	BP6ES	7811						
OE110	BCPR7ES	3330						
OE111	BPR6ES	7822						
OE112	D8EVX	2850						
OE113	BPR6ES-11	4824						
OE115	FR5-1	7252						
OE116	BPR8ES	3923						
OE117	BPR7ES-11	7226						
OE118	BCPR6ET	2197						
OE119	BKR6E	6962						
OE121	BKR5E	7938						
OE122	PMR8A	5851						
OE125	B9EVX	7254						
OE126	PFR7B	4853						
OE127	BKR6E	6962						
OE128	ZFR5F-11	2262						
OE129	BKR7EVX	3544						
OE130	LZKAR7A	6799						
OE134	BKR6EP-13	2550						
OE135	LF4AP-11	5613						
OE136	PFR6J-11	2743						
OE137	BKR5E-11	6953						
OE138	PFR6N-11	3546						
OE141	BKR6EVX	3539						
OE143	PFR6G-9	4377						
OE144	BKR6EVX	3539						
OE145	BKR6EVX	3539						
OE146	PFR6N-11	3546						
OE147	ZFR6F-11	4291						
OE148	LF5A-11	6376						
OE150	PMR8A	5851						
OE151	BPR5EFS	2223						
OE152	BKR6E-11	2756						
OE153	BKR6EZ	4619						
OE154	ZFR5F-11	2262						
OE155	APR6FS	2922						
OE156	ZGR5C	6334						
OE157	BCR8ES	5430						
OE162	BR6ES	4922						
OE163	LZTR4A-11	5444						
OE167	LZTR5AIX-13	2314						
OE171	BPR6FS	2623						
OE175	LF5AP-11	4775						
OE176	PZFR5D-11	7968						
OJ12Y	BP5S	3011						
OJ13Y	BP5S	3011						
ON11Y	BPR5ES	7422						
ON12Y	BPR5ES	7422						
ON3	BR8ES	5422						
P10Y	D6HA	6512						
P7	D8HA	7112						

CHAMPION	NGK → STOCK No.	CHAMPION	NGK → STOCK No.	CHAMPION	NGK → STOCK No.	CHAMPION	NGK → STOCK No.				
P8Y	D6HA	6512	RBN14Y	BPR5EFS	2223	RD14	AB6	2910	RL82C	BR6HS	3922
PG2PHP	PMR8A	5851	RBN9Y	BPR6EFS	3623	RD16	A6	1010	RL82Y	BPR6HS	7022
PG4PHP	PMR7A	4259	RC10DMC	BKR5EK	7956	RD16	AB6	2910	RL82YC	BPR6HS	7022
PZ7HC	CR7HSA	4549	RC10ECC	ZFR6F-11	4291	RD16J	A6	1010	RL82YCC	BPR6HS	7022
Q504V	R2349-10	6839	RC10PYC	BKR6EVX	3539	RD16J	AB6	2910	RL85	BR6HS	3922
QC12PEP	PZFR6H	7696	RC10PYP4	PFR5J-11	4642	RD9	A6	1010	RL85C	BR6HS	3922
QC12YC	BKR5E	7938	RC10PYPB4	PFR5G-11	2647	RD9	AB6	2910	RL86	BR6HS	3922
QC501V	R7434-10	4894	RC10VTYC4	BKUR5ET-10	7553	RDJ7J	BMR6F	2144	RL86C	BR6HS	3922
QC59C	BCR8ES	5430	RC10YC	BCPR6ES	2330	RDJ7Y	BPMR6F	1270	RL87Y	BPR6HS	7022
QC9MC4	ZFR6F-11	4291	RC10YC4	BKR6E-11	2756	RDJ8J	BMR6F	2144	RL87YC	BPR6HS	7022
QCJ8Y	BPMR6A	6726	RC10YCC	BKR6E	6962	RE14MCC4	LZTR4A-11	5444	RL90	BR5HS	3722
QJ19LM	BR2LM	5798	RC10YCC4	BKR6E-11	2756	RE14MCC5	LZTR4A-11	5444	RL95YC	BPR5HS	6222
QL16V	BUZ8H	7447	RC10YCL	BKR5EZ	7642	RE14PLP5	LZTR5AIX-13	2314	RN10GY	BPR6EIX	6637
QL7J5	BR6HS	3922	RC11PYPB4	PFR6N-11	3546	RE7PYC5	PTR5A-10	5055	RN10VTYC	BUR5ET	3377
QL76V	BUZHW	2147	RC12ECC	FR5-1	7252	RE7YCC	TR5A-10	0005	RN10VTYC4	BUR5ET-10	7264
QL77CC	BZ7HS-10	3579	RC12LC	ZFR5F	5165	REA8MCL	LZKAR7A	6799	RN10Y	BPR6ES	7822
QL77J4	BZ7HS-10	3579	RC12LC4	ZFR5F-11	2262	REC10PYC4	LF5A-11	4775	RN10Y4	BPR6ES-11	4824
QL77JC4	BZ7HS-10	3579	RC12LYC	FR5-1	7252	REC10YC4	LF5A-11	6376	RN11Y	BPR5ES	7422
QL78C	BZ7HS-10	3579	RC12MC5	ZFR5F-11	2262	REC14PLP5	LZTR5AIX-13	2314	RN11YC	BPR5ES	7422
QL78V	BUZHW-2	2173	RC12MCC4	ZFR5F-11	2262	REC14PYC	LF5A-11	5613	RN11YC4	BPR5ES-11	4424
QL87YC	BPZ7HS-10	1093	RC12PYP	BKR6E-13	2550	REC9YCL	LF5B	7113	RN11YCC	BPR5ES	7422
QL81Y	BPZ7HS-10	1093	RC12YC	BKR5E	7938	RES9PYP4	PTR5A-10	5055	RN11YCC4	BPR5ES-11	4424
QL82C	BR6HS	3922	RC12YC5	BKR5E-11	6953	RES9YCC4	TR5A-10	0005	RN12Y	BPR5ES	7422
QL82YC	BPR6HS	7022	RC12YCC	BKR5E	7938	RF11Y	APR6FS	2922	RN12YC	BPR5ES	7422
QL86	BR6HS	3922	RC12YCC4	BKR5E-11	6953	RF11YC	APR6FS	2922	RN12YC4	BPR5ES-11	4424
QL86C	BR6HS	3922	RC14YC	BKR5E	7938	RF14Y	APR5FS	3122	RN12YC6	BPR5ES-13	3154
QL87YC	BPR6HS	7022	RC61YC	BCR8ES	5430	RF7YC	APR6FS	2922	RN12VCC	BPR5ES	7422
QN2	BR9ES	5722	RC6PYP	PFR7B	4853	RF7YCC	APR6FS	2922	RN13L	ZGR5C	6334
QN2C	BR9ES	5722	RC6VPYC	BKR7EVX	3544	RF9Y	APR6FS	2922	RN13LYC	ZGR5C	6334
QN2G	BR9EIX	3981	RC6YC	BCPR7ES	3330	RF9Y5	APR6FS	2922	RN14LY	ZGR5C	6334
QN3	BR8ES	5422	RC6YCC	BCPR7ES	3330	RF9YC	APR6FS	2922	RN14MC5	BPR5EY-11	3028
QN3C	BR8ES	5422	RC7BMC	BCPR6ET	2197	RFN14LY	ZFR4F-11	4043	RN14PMP5	BPR5EP-11	3971
QN84	BR9EG	3230	RC7BYC4	BCPR6ET	2197	RG2PHP	CR8EIX	4218	RN14Y	BPR5ES	7422
QN86	BR8EG	3130	RC7GYC	BKR7EVX	3544	RG4HC	CR9EB	6955	RN14Y6	BPR5ES-13	3154
R10	D6EA	7512	RC7Y	BCPR7ES	3330	RG4PHP	PMR8A	5851	RN14YC	BPR5ES	7422
R54G	R217-11	1072	RC7YC	BCPR7ES	3330	RG6PP	PMR8A	5851	RN16Y	BPR4ES	7222
R6	D8EA	2120	RC7YC4	BKR7E-11	1283	RG6YC	CR8EB	7784	RN1C	BR10ES	4832
R6G	D8EVX	2850	RC7YCC	BCPR7ES	3330	RG6YCA	CPR8E	7411	RN2	BR9ES	5722
R8	D7EA	7912	RC7YCC4	BKR7E-11	1283	RG6YCH	CPR8E	7411	RN2C	BR9ES	5722
RA2HC	DPR9EA-9	5329	RC78PYP	PFR7G-11	2380	RG92C	CR9E	6263	RN2G	BR9EIX	3981
RA4HC	DCPR9E	2641	RC8BYC	BKR6EKC	2848	RG92DC	CR9EK	4548	RN3	BR8ES	5422
RA4HCC	DCPR8E	4179	RC8DMC	BKR6EK	2288	RG94C	CR8E	1275	RN3C	BR8ES	5422
RA4HCX	DCPR8E-N	5692	RC8PYCB	PFR6G-9	4377	RGU92C	CR9EH-9	7502	RN3G	BR8EIX	5044
RA59GC	DCR9EIX	6650	RC8PYP	PFR6J-11	2743	RGU94C	CR8EH-9	5666	RN4	BR7ES	5122
RA6	DR8ES-L	2923	RC8PYPB4	PFR6N-11	3546	RH10C	B6L	3212	RN4C	BR7ES	5122
RA6HC	DCPR8E	4339	RC8PYX	BKR6EVX	3539	RH-18Y	B-4L	3112	RN5	BR6ES	4922
RA6Y	DPR8EA-9	4929	RC8VTYC4	BKUR6ET-10	2397	RJ11	BR6S	3522	RN57YC	BR10EG	3830
RA6YC	DPR8EA-9	4929	RC8YC	BKR6E	6962	RJ11Y	BP5S	3011	RN57YCC	BR10EG	3830
RA8HC	DCPR7E	3932	RC8YC4	BKR6E-11	2756	RJ12	BR6S	3522	RN5C	BR6ES	4922
RA8Y	DPR7EA-9	5129	RC8YCC	BKR6E	6962	RJ12C	BR6S	3522	RN6	BR6ES	4922
RA8YC	DPR7EA-9	5129	RC8YCC4	BKR6E-11	2756	RJ12Y	BP5S	3011	RN6Y	BPR8ES	3923
RAX92C	DR9EA	3437	RC8YCL	BKR6EZ	4619	RJ12YC	BP5S	3011	RN6YC	BPR8ES	3923
RAX92DC	JR9C	6193	RC87LYC	BKR6E	6962	RJ14Y	BP5S	3011	RN7GY	BPR7EIX	4055
RAX92YC	DPR9EA-9	5329	RC87PYC	BKR6EVX	3539	RJ14YC	BP5S	3011	RN7Y	BPR7ES	2023
RAX94C	DR8EA	7162	RC87YCC	BKR6ES	3783	RJ17LM	BR4LM	4133	RN7YC	BPR7ES	2023
RAX94YC	DPR8EA-9	4929	RC87YCL	BKR6EZ	4619	RJ18Y	BP4	2911	RN7YCC	BPR7ES	2023
RAX96C	DR7EA	7839	RC89PYC	BKR6EVX	3539	RJ18YC	BP4	2911	RN7YCC4	BPR7ES-11	7226
RAX96YC	DPR7EA-9	5129	RC89YCC	BKR6ES	3783	RJ19LM	BR2LM	5798	RN8	BR5ES	4722
RBL11Y	BPR5FS	2423	RC9BMC	BKR5EKU	3964	RJ20Y	BP4	2911	RN8L	ZGR5C	6334
RBL11Y6	BPR5FS-15	3124	RC9MC4	ZFR5F-11	2262	RJ6	BR6S	3522	RN8VTYC4	BUR6ET	3172
RBL12	BR5FS	4123	RC9MCC4	ZFR6F-11	4291	RJ6C	BR6S	3522	RN9GY	BPR6EIX	6637
RBL12-6	BR5FS-15	2224	RC9Y	BKR6E	6962	RJ6J	BR6S	3522	RN9LCC	ZGR5B	7345
RBL13Y	BPR5FS	2423	RC9YC	BKR6E	6962	RJ7	BR6S	3522	RN9Y	BPR6ES	7822
RBL13Y6	BPR5FS-15	3124	RC9YC4	BCPR6ES-11	7121	RJ8	BR6S	3522	RN9YC	BPR6ES	7822
RBL15Y	BPR4FS	1127	RC9YCC	BKR6E	6962	RJ8C	BR6S	3522	RN9YC4	BPR6ES-11	4824
RBL15Y4	BPR4FS-11	2527	RC9YCC4	BCPR6ES-11	7121	RJ8J	BR6S	3522	RN9YCC	BPR6ES	7822
RBL15Y6	BPR4FS-15	2727	RCJ4	BMR7A	4226	RL12Y	BPR6HS	7022	RN9YCC4	BPR6ES-11	4824
RBL16Y	BPR4FS	1127	RCJ501H	BPMR4A	6028	RL19	BR5HS	3722	RP10HC	DR5HS	4623
RBL17Y	BPR4FS	1127	RCJ6	BMR7A	4226	RL4J	BR7HS	4122	RP7	DR8HS	5123
RBL17Y6	BPR4FS-15	2727	RCJ6Y	BPMR7A	4626	RL77J	BR7HS	4122	RS12YC	BPR5EFS	2223
RBL8	BR6FS	4323	RCJ7Y	BPMR7A	4626	RL78	BR7HS	4122	RS14YC	BPR5EFS	2223
RBL9Y	BPR6FS	2623	RCJ8	BMR6A	7421	RL78C	BR7HS	4122	RS5C	BR7EFS	1094
RBN12Y	BPR5EFS	2223	RCJ8Y	BPMR6A	6726	RL7J	BR6HS	3922	RS9YC	BPR6EFS	3623
RBN13Y	BPR5EFS	2223	RD14	A6	1010	RL82	BR6HS	3922	RS9YCC	BPR6EFS	3623

CHAMPION	NGK → STOCK No.	
RV12C	BR5FS	4123
RV12C6	BR5FS-15	2224
RV12YC	BPR5FS	2423
RV12YC6	BPR5FS-15	3124
RV15YC	BPR4FS	1127
RV15YC4	BPR4FS-11	2527
RV15YC6	BPR4FS-15	2727
RV17YC	BPR4FS	1127
RV17YC6	BPR4FS-15	2727
RV19YC	BPR4FS	1127
RV8C	BR6FS	4323
RV9YC	BPR6FS	2623
RZ7C	CMR7H	3066
RZ94C	CR8HS	7423
RZ98C	CR6HS	7023
RZN12Y	BPR5EFS	2223
RZN12Y5	BPR5EFS	2223
S10YCC	BP5EFS	3712
S12YC	BP5EFS	3712
S279YC	BP6EFS	3812
S281YC	BP6EFS	3812
S379YC	BP7EFS	3526
S6YC	BP7EFS	3526
S6YCC	BP7EFS	3526
S7YC	BP7EFS	3526
S7YCC	BP7EFS	3526
S9YC	BP6EFS	3812
S9YCC	BP6EFS	3812
UD16	A6	1010
UD16	AB6	2910
UF-11Y	APR5FS	3122
UF-14Y	APR5FS	3122
UF-9Y	APR6FS	2922
UJ12	B2	3110
UJ2J	B8S	3810
UJ4J	B7S	3710
UJ6	B6S	3510
UJ8	B6S	3510
UJ81C	B7S	3710
UJ81J	B7S	3710
UK10	A6	1010
UK10	AB6	2910
UL17V	BUHXW-1	5526
UL18V	BUHX	2522
UL4J	B7HS	5110
UL77V	BUHXW-1	5526
UL81C	B7HS	5110
UL81J	B7HS	5110
UN12Y	BP5ES	6511
UN19V	BUE	2322
UN79Y	BP6ES	7811
V12YC	BP5FS	3412
V4C	B7FS	3027
V59C	R5673-9	3856
V9YC	BP6FS	3512
XJ-8	BR6S	3522
XL-10	BR6HS	3922
XN-8	BR6ES	4922
Y82	CM-6	5812
Z10	C6HSA	3228
Z12	C6HSA	3228
Z6	C8HSA	6821
Z8	C7HSA	4629
Z9Y	C7HSA	4629
CHRYSLER	NGK → STOCK No.	
04606402AB	LZTR4A-11	5444
04606591AB	ZFR5LP-13G	7781
SZFR5LP13G	ZFR5LP-13G	7781
CHINESE BRANDS	NGK → STOCK No.	
A6C	C6HSA	3228
A6RTC	CR6HSA	2983
A6RC	CR6HSA	2983

CHINESE BRANDS	NGK → STOCK No.	
A6TC	C6HSA	3228
A7C	C7HSA	4629
A7RC	CR7HSA	4549
A7RTC	CR7HSA	4549
A7TC	C7HSA	4629
A8C	C8HSA	6821
A8RC	CR8HSA	2086
A8RTC	CR8HSA	2086
A8TC	CR8HSA	6821
B7	C7E	5096
B7R	CR7E	4578
B7RD	CR7EK	7546
B8	C8E	7471
B9	C9E	7499
B9R	CR9E	6263
B9RD	CR9EK	4548
D7C	D7EA	7912
D7RC	DR7EA	7839
D8C	D8EA	2120
D8RC	DR8EA	7162
D8RTC	DR8EA	7162
D8TC	D8EA	2120
D9C	D9EA	2420
D9RC	DR9EA	3437
DK6RTC	DCPR6E	3481
DK7RTC	DCPR7E	3932
DK8RTC	DCPR8E	4339
E5C	B5HS	4210
E5RC	BR5HS	3722
E5RTC	BPR5HS	6222
E5T	BP5HS	4111
E5TC	BP5HS	4111
E6C	B6HS	4510
E6RC	BR6HS	3922
E6RTC	BPR6HS	7022
E6T	BP6HS	4511
E6TC	BP6HS	4511
E7C	B7HS	5110
E7RC	BR7HS	4122
E7RTC	BPR7HS	6422
E7TC	BP7HS	5111
E8C	B8HS	5510
E8RC	BR8HS	4322
E8RTC	BPR8HS	3725
E8TC	BP8HS	2630
F5TC	BP5ES	6511
F6C	B6ES	7310
F6RC	BR6ES	4922
F6RJY	BUR6ET	3172
F6RTC	BPR6ES	7822
F6TC	BP7ES	2412
F6TJC	BP6ET	1263
F7C	B7ES	1111
F7RC	BR7ES	5122
F7RTC	BPR7ES	2023
F7TC	BP7ES	2412
F8C	B8ES	2411
F8RC	BR8ES	5422
GL4	B4LM	3410
K5RF	BKR5E	7938
K5RF-11	BKR5E-11	6953
K5RTC	BKR5E	7938
K5RTC-11	BKR5E-11	6953
K6RF	BKR6E	6962
K6RF-11	BKR6E-11	2756
K6RTC	BKR6E	6962
K6RTC-11	BKR6E-11	2756
L4C	BM4A	5628
L4RTC	BPMR4A	6028
L6C	BM6A	5921
L6RTC	BPMR6A	6726
L6TC	BPM6A	7021
L7C	BM7A	6521
L7RTC	BPMR7A	4626

CHINESE BRANDS	NGK → STOCK No.	
L7TC	BPM7A	7321
LR4C	BMR4A	5728
LR6C	BMR6A	7421
LR7C	BMR7A	4226
T1137C	C7HSA	4629
T4197JC	BP7ES	2412
CITROEN	NGK → STOCK No.	
59622A	BPR6ES	7822
59622T	BKR6EKC	2848
59622X	BKR6E	6962
5962IA	BP5ET	2287
5962IK	BKR6EK	2288
5962IL	BKR5EK	7956
5962OE	BKR6EK	2288
5962S7	BP5ES	6511
5962TO	BKR6E	6962
5962W1	BCPR5ES	6130
5962X8	BCP6ES	4930
5962Z1	BKR6EK	2288
5962Z6	BKR5EK	7956
95496692	BP6HS	4511
95605398	B6HS	4510
95611941	BP6EFS	3812
95619043	BP6ES	7811
96000090	BCP5ES	7496
96037952	BCP5ES	7496
96039962	BCP6ET	4563
96064890	BCPR5ES	6130
96097486	BCP7ET	2078
96145071	BCPR6ET	2197
97533994	BP7EFS	3526
AM212207A	B6HS	4510
MKP00073	BP7ES	2412
ZC9862090U	BP5ES	6511
ZCT000011	BP6HS	4511
ZCT000012	BP7ES	2412
DAIHATSU	NGK → STOCK No.	
90048-51006-000	B8ES	2411
90048-51008-000	B7ES	1111
90048-51015-000	B6ES	7310
90048-51020-000	B4H	4110
90048-51022-000	B6HS	4510
90048-51033-000	B5ES	6410
90048-51034-000	BP6ES	7811
90048-51034-010	BP6ES	7811
90048-51047-010	BP5EA-L	6111
90048-51048-000	BPR5EA-L	5823
90048-51053-000	BP5EY	7327
90048-51054-000	BPR5EY	2828
90048-51059-000	BPR6EY	6427
90048-51069-000	BP6EY	7727
90048-51072-000	BP5ES	6511
90048-51077-000	BPR6EKN	1128
90048-51093-000	BPR5EY-11	3028
90048-51096-000	BPR6ES	7822
90048-51097-000	BP2ES	3467
90048-51100-000	BKR6E-11	2756
90048-51104-000	BPR6EKN	1128
90048-51105-000	BPR7EKN	7738
90048-51114-000	BPR5ES	7422
90048-51118-000	PPR6B-11	4014
90048-51136-000	BKUR6EK	2213
90048-51137-000	BKUR6EK	2213
90048-51152-000	BKR6E	6962
90048-51169-000	BKUR6ETB-10	5742
90048-51185-000	LFRC6-11	5788
90048-51200-000	IKR7D	4759
90919-01061-000	BP5EA-L	6111
90919-01116-000	BPR5EP-11	3971
991-1339-2361-0	AB6	2910
991-2311-2361-00AB7		3010
992-5130-2001-00B4		3210

DAIHATSU	NGK → STOCK No.	
995-2021-2361-32B8HS		5510
999-3400-6911-00BP6EVX		5832
999-3401-6911-00BP5EVX		5470
999-3403-6911-00B7EVX		6934
999-3407-6911-00BP5HS		4111
999-3409-6911-00BP6HS		4511
DENSO	NGK → STOCK No.	
90919-01217	IFR5T11	4996
90919-01218	IFR5T11	4996
90919-01240	IFR5T11	4996
9807B-5615P	ZFR6K-11	6711
9807B-5615W	IZFR6K11	6994
FXE20HR11	PLZKAR6A-11	5118
IA01-32	R7282A-105	4614
IA01-34	R7282A-11	4754
IAE01-32	R7282-105	4985
IAE01-34	R7282-11	2001
IK01-24	R7434-8	4892
IK01-27	R7434-9	4658
IK01-31	R7434-10	4894
IK02-24	R7434-8	4892
IK02-27	R7434-9	4658
IK02-31	R7434-10	4894
IK16	BKR5EIX-11	5464
IK16G	BKR5EIX-11	5464
IK16L	ZFR5FIX-11	2477
IK20	BKR6EIX-11	3764
IK20G	BKR6EIX-11	3764
IK20L	ZFR6FIX-11	6441
IK22	BKR7EIX	2667
IK22G	BKR7EIX	2667
IK24	BKR8EIX	2668
IK27	BKR9EIX	2669
IK27C11	FR9BI-11	4709
IK31	R7434-10	4894
IKH01-24	R7438-8	4905
IKH01-27	R7438-9	4656
IKH22	ILFR7H	5245
IQ01-24	R7436-8	4898
IQ01-27	R7436-9	4899
IQ01-31	R7436-10	4900
IQ02-24	R7436-8	4898
IQ02-27	R7436-9	4899
IQ02-31	R7436-10	4900
IQ16	BCPR5EIX-11	3306
IQ20	BCPR6EIX-11	4919
IT20	BPR6EFIX-10	6891
ITL16	LZTR5AIX-13	2314
ITV16	LTR5IX-11	4344
IU01-27	R0373A-9	3388
IU01-31	R0373A-10	4940
IU01-34	R0373A-11	5566
IU22	CR7EIX	7385
IU24	CR8EIX	4218
IU27	CR9EIX	3521
IU27D	CR9EIA-9	6289
IUF22	CR7HIX	7544
IUF24	CR8HIX	7669
IUH24	CR8EHIX-9	3797
IUH27	CR9EHIX-9	6216
IUH27D	CR9EIH-9	6419
IW01-27	R7376-9	7763
IW01-31	R7376-10	4457
IW06-27	R7376-9	7763
IW06-31	R7376-10	4457
IW20	BPR6EIX-11	3903
IW22	BPR7EIX	4055
IW24	BR8EIX	5044
IW27	BR9EIX	3981
IW31	BR10EIX	6801
IWF20	BPR6HIX	4085
IWF22	BR7HIX	7067
IWF24	BR8HIX	7001

DENSO	NGK → STOCK No.	DENSO	NGK → STOCK No.	DENSO	NGK → STOCK No.	DENSO	NGK → STOCK No.				
IWM-01-32	R6179A-105P	2697	PQ16R8	BCPR5EP-8	2950	U20FS-U	C6HSA	3228	W16EPR-U	BPR5ES	7422
IX22B	DRP7EIX-9	7803	PQ20R	BCPR6EP-11	3350	U20M-U	CM-6	5812	W16EPR-U11	BPR5ES-11	4424
IX24	DR8EIX	6681	PQ20R-P11	BCPR6EP-N-11	4497	U22ES-N	C7E	5096	W16EP-U	BP5ES	6511
IX24B	DRP8EIX-9	2202	PQ20R-P8	BCPR6EP-N-8	5275	U22ESR-N	CR7E	4578	W16EP-ZU	BP5EVX	5470
IX27	DR9EIX	4772	PT16EPRL13	PTR5D-10	3784	U22FS	C7HSA	4629	W16ES	B5ES	6410
IX27B	DRP9EIX-9	5545	PT16VR-13	PTR5A-10	5055	U22FS-L	C7HSA	4629	W16ES-L	BR5ES	4722
IXU22	DCPR7EIX	6046	PTJ16CR15	PZTR5A-15	7862	U22FSR-L	CR7HS	7223	W16ESR-U	BR5ES	4722
IXU24	DCPR8EIX	6546	Q16PR-U	BCPR5E	1145	U22FSR-U	CR7HSA	4549	W16ES-U	B5ES	6410
IXU27	DCPR9EIX	2316	Q20PR-U	BKR6E	6962	U22FS-U	C7HSA	4629	W16EXR-U	BPR5EY	2828
K14P-U11	BKR5E-11	6953	Q20PR-U11	BCPR6E-11	3132	U24ES-N	C8E	7471	W16EXR-U11	BPR5EY-11	3028
K16HPR-U11	LF5A-11	6376	Q20P-U	BCP6ES	4930	U24ESR-N	CR8E	1275	W16EX-U	BP5EA-L	6111
K16PRP11	BKR5EVX	2546	Q20R-U11	BCPR6EY-11	3720	U24ESR-NB	CR8EB	7784	W16FP	BP5HS	4111
K16PR-U	BKR5E	7938	Q22PR-U	BCPR7ES	3330	U24ESR-NZU	CR8EIX	4218	W16FPR	BPR5HS	6222
K16PR-U11	BKR5E-11	6953	Q22PR-U11	BCPR7ES-11	1095	U24ETR	CR8EK	3478	W16FPR-U	BPR5HS	6222
K16R-U	BKR5EYA	2087	Q22P-U	BCP7ES	5030	U24FER9	CR8EH-9	5666	W16FP-U	BP5HS	4111
K16R-U11	BKR5EYA-11	2526	Q27A-Z	R7232-9	5516	U24FS	C8HSA	6821	W16FS	B5HS	4210
K16TR-11	BKR5EKB-11	3967	QJ16AR-U	BCRE527Y	2074	U24FS-C	C8HSA	6821	W16FSR	BR5HS	3722
K20BR-S10	BKUR6ETB-10	5742	QJ20CR-11	ZFR6A-11	1041	U24FS-L	C8HSA	6821	W16FS-U	B5HS	4210
K20HR-U11	LF6C-11	5788	S22PR-A7	IGR7A	6687	U24FSR-C	CR8HSA	2086	W16LS	B6L	3212
K20PR-L11	BKR6E-N-11	5724	SF-10	BUHX	2522	U24FSR-U	CR8HS	7423	W16P-U	BP5S	3011
K20PR-U	BKR6E	6962	SF-50	BUHW	2622	U24FS-U	C8HSA	6821	W20EPB	BP6ET	1263
K20PR-U11	BKR6E-11	2756	SF-51	BUHW-2	5626	U27ES-N	C9E	7499	W20EPBRS	BUR6ET	3172
K20P-U	BK6E	3536	SK16PR11	IFR5G-11K	3107	U27ESR-N	CR9E	6263	W20EP-GU	BP6EVX	5832
K20R-U	BKR6EYA	2249	SK16PR-A11	IFR5E11	7994	U27ESR-NB	CR9EB	6955	W20EPR-U	BPR6ES	7822
K20R-ZU11	BKR6EP-11	2978	SK16PR-L11	IFR5G-11K	3107	U27ESR-NZU	CR9EIX	3521	W20EPR-U10	BPR6ES-11	4824
K20TNR	BKR6EK	2848	SK16R11	IFR5T11	4996	U27ETR	CR9EK	4548	W20EPR-U11	BPR6ES-11	4824
K20TNR-S	BKUR6EK	2213	SK16R-P8	IFR5T-8N	3508	U27FER-9	CR9EH-9	7502	W20EP-U	BP6ES	7811
K20TR-11	BKR6EKB-11	3583	SK20PR-A11	IFR6E11	6741	U27FER-ZU9	CR9EHIX-9	6216	W20EP-ZU	BP6EVX	5832
K20TRX	BKR6EKU	6993	SK20R11	IFR6T11	4589	U31ESR-N	CR10E	6264	W20ES	B6ES	7310
K22PB	BCP7ET	2078	SK20R-P11	IFR6T11	4589	U31ESR-NZU	CR10EIX	6482	W20ES-L	BR6ES	4922
K22PBR-S	BKUR7ET	7873	SK22PR-M11	IFR7G-11KS	7746	U31ETR	CR10EK	2360	W20ESR	BR6ES	4922
K22PR-U	BKR7E	6097	SK22PR-M11S	IFR7G-11KS	7746	VK16PR-Z11	IFR5L11	6502	W20ESR-L	BR6ES	4922
K22PR-U11	BKR7E-11	1283	SKJ16CR-A8	IZFR5G	5887	VK20PR-Z11	IFR6L11	3678	W20ES-U	B6ES	7310
K22TMR	BKR7EKC-N	2095	SKJ20DR-M11	IZFR6K11	6994	VK20T	BKR6EIX-LPG	3356	W20ETR-L	BPR6EKN	1128
KJ16CR-L11	ZFR5J-11	5584	SKJ20DR-M11S	IZFR6K-11S	5266	VK24PR-Z11	IFR8H11	5068	W20EXR-U	BPR6EY	6427
KJ20CR-11	ZFR6F-11	4291	SVK20R-Z11	IFR6J11	7658	VK27PR-Z11	IFR9H11	6588	W20EXR-U11	BPR6EY-11	4228
KJ20CR-U11	ZFR6F-11	4291	SVK20R-Z8	BKR6EP-8	2215	VKH22	ILFR7H	5245	W20EX-U	BP6EY	7727
KJ20CR-L11	ZFR6J-11	5585	SXU22PR9	IKR7D	4759	VKJ20RZ-M11	IZFR6F11	4095	W20FP	BP6HS	4511
KJ20DR-M11	ZFR6K-11	6711	T14PR-U	BPR4FS	1127	VNH27Z	IMR9B-9H	4888	W20FPR	BPR6HS	7022
KJ22CR-L11	ZFR7F-11	2975	T14PR-U15	BPR4FS-15	2727	VUH24D	IMR8C-9H	3653	W20FPR-U	BPR6HS	7022
L14-U	A6	1010	T16EPR-U	BPR5EFS	2223	VUH27D	IMR9C-9H	6777	W20FP-U	BP6HS	4511
L14-U	AB6	2910	T16EX-U	BP5EFS	3712	VUH27ES	IMR9C-9HES	5766	W20FP-U10	BP6HS-10	6326
M17	A6	1010	T16PR-U	BPR5FS	2423	VUH27Z	IMR9A-9H	6966	W20FR-L	BPR6HSA	4632
M17	AB6	2910	T16PR-U11	BPR5FS-11	2924	VW20T	BPR6EIX-LPG	2347	W20FS	B6HS	4510
M22	A7	1110	T16PR-U15	BPR5FS-15	3124	VW22	BPR7EIX	4055	W20FSR	BR6HS	3922
M22	AB7	3010	T16P-U	BP5FS	3412	VX22BC	IJR7A9	7901	W20FSR-U	BR6HS	3922
M24S	A8	1210	T16R-U	BR5FS	4123	VX22BZ	IJR7A9	7901	W20FS-U	B6HS	4510
MA16PR-U	APR5FS	3122	T16R-U15	BR5FS-15	2224	W14	B4	3210	W20M	BM6A	5921
MA16PR-U11	APR5FS	3122	T16VR-U10	TR5A-10	0005	W14E	B4ES	4129	W20MP-U	BPM6A	7021
MA16PR-U15	APR5FS	3122	T16VR-U11	TR5A-10	0005	W14EPR-U	BPR4ES	7222	W20MR-U	BMR6A	7421
MA17P-U	AP6FS	2710	T20EPR-U	BPR6EFS	3623	W14F	B4H	4110	W20M-U	BM6A	5921
MA20PR-U	APR6FS	2922	T20EP-U	BP6EFS	3812	W14FP	BP4HS	3611	W20M-US	BM6A	5921
MA20P-U	AP6FS	2710	T20EX-U	BP6EFS	3812	W14FP-L	BP4HS	3611	W20S	B6S	3510
P16R	BPR5EP-11	3971	T20MP-U	BPM6F	5950	W14FPR	BPR4HS	7823	W20SR-U	BR6S	3522
P20PR8	PGR6A	4984	T20M-U	BM6F	6221	W14FPR-L	BPR4HS	7823	W20S-U	B6S	3510
P22PR8	PGR7A	3200	T20PR-U	BPR6FS	2623	W14FPR-UL	BPR4HS	7823	W22EB	BR7ET	4121
PK16PR11	PFR5B-11	2300	T20PR-U15	BPR6FS	2623	W14FPR-UL10	BPR4HS-10	5024	W22EBR	BR7ET	4121
PK16PR-L11	PFR5G-11	2647	T20P-U	BP6FS	3512	W14FP-U	BP4HS	3611	W22EDR	BR7EQ	5128
PK16PR-P11	PFR5J-11	4642	T20R-U	BR6FS	4323	W14FP-UL	BP4HS	3611	W22EP	BP7ES	2412
PK16R11	BKR5EP-11	3440	T22EP-U	BP7EFS	3526	W14FR-U	BR4HS	3322	W22EP-GU	BP7EVX	7270
PK20PR11	PFR6B-11	4014	T22MP-U	BPM7F	1268	W14F-U	B4H	4110	W22EPR-U	BPR7ES	2023
PK20PR-L11	PFR6G-11	5555	T22M-U	BM7F	6421	W14L	B4L	3112	W22EP-U	BP7ES	2412
PK20PR-P11	PFR6J-11	2743	TR20	B6HS	4510	W14LMR-US	BR4LM	4133	W22EP-ZU	BP7EVX	7270
PK20PR-P8	PFR7B	4853	TR22	B7HS	5110	W14LM-U	B4LM	3410	W22ES	B7ES	1111
PK20R11	BKR6EP-11	2978	TR22-10	B7HS-10	2129	W14LM-US	B4LM	3410	W22ES-GU	B7EVX	6934
PK20R-13	BKR6EP-13	2550	TR24	B8HS	5510	W14MMPR-U10	BPMR4A	6028	W22ESR	BR7ES	5122
PK20R8	BKR6EP-8	2215	TR24-10	B8HS-10	5126	W14MR-U	BMR4A	5728	W22ESR-U	BR7ES	5122
PK20TR11	BKR6EKP-11	3452	U14FSR-UB	CR4HSB	4695	W14M-U	BM4A	5628	W22ES-U	B7ES	1111
PK22PR8	PFR7B	4853	U16FER-9	CR5EH-9	6689	W14M-US	BM4A	5628	W22ES-ZU	B7EVX	6934
PK22PR-TP	PFR7M	4877	U16FSR-UB	CR5HSB	6535	W14P	BP5S	3011	W22FP	BP7HS	5111
PKJ16CR-L11	PZFR5F-11	4363	U20EPR-U	CPR6EA-9	6899	W14PR-U	BP4	2911	W22FPR-U	BPR7HS	6422
PKJ20CR8	PZFR6F	7550	U20FS	C6HSA	3228	W14-U	B4	3210	W22FP-U	BP7HS	5111
PKJ20CR-L11	PZFR6F-11	3271	U20FS-L	C6HSA	3228	W14-US	B4	3210	W22FP-U10	BP7HS-10	7829
PQ16R	BCPR5EP-11	2097	U20FSR-U	CR6HSA	2983	W16EP-GU	BP5EVX	5470	W22FS	B7HS	5110

DENSO	NGK → STOCK No.	
W22FS-GU	B7HVX	7836
W22FSR	BR7HS	4122
W22FS-U	B7HS	5110
W22FS-ZU	B7HVX	7836
W22M	BM7A	6521
W22MPR-U	BPMR7A	4626
W22MP-U	BPM7A	7321
W22MP-US	BPM7A	7321
W22M-U	BM7A	6521
W22M-US	BM7A	6521
W22S	B7S	3710
W22S-U	B7S	3710
W24EP	BP8ES	2912
W24EP-11	BP8ES	2912
W24EP-U	BP8ES	2912
W24ES	B8ES	2411
W24ES-GU	B8EVX	7051
W24ESR	BR8ES	5422
W24ESR-U	BR8ES	5422
W24ESR-ZU	BR8EIX	5044
W24ES-U	B8ES	2411
W24ES-V	B8EG	3430
W24ES-ZU	B8EGV	5627
W24FPR	BPR8HS	3725
W24FP-U	BP8HS	2630
W24FS	B8HS	5510
W24FS-GU	B8HVX	2634
W24FSR	BR8HS	4322
W24FS-U	B8HS	5510
W24FS-U10	B8HS-10	5126
W24FS-ZU	B8HVX	2634
W24S	B8S	3810
W24S-U	B8S	3810
W25EB	BR8ET	4221
W25EBR	BR8ET	4221
W25EDR	BR8EQ	3328
W25EN	B8EG	3430
W25EPT	B8EGP	2046
W25FN	B8HVX	2634
W27EBR	BR9ET	4528
W27EMR-C	BR9ECM	3252
W27EN	B9EG	3530
W27EPT	B9EGP	2176
W27ES	B9ES	2611
W27ES-GU	B9EVX	7254
W27ESR	BR9ES	5722
W27ES-U	B9ES	2611
W27ES-V	B9EG	3530
W27ES-ZU	B9EGV	5827
W27FS	B9HS	5810
W27FS-GU	B9HVX	2254
W27FSR	BR9HS	4522
W27FS-U	B9HS	5810
W27FS-U10	B9HS-10	3626
W27FS-ZU	B9HVX	2254
W29ES-GU	B95EGV	2145
W29ES-ZU	B95EGV	2145
W31EN	B10EG	3630
W31EPT	B10EGP	5224
W31ES-GU	B10EVX	7335
W31ESR-U	BR10ES	4832
W31ES-ZU	B10EGV	5927
W31FS-GU	B10HVX	2940
W31FS-ZU	B10HVX	2940
W32EPT	B105EGP	2077
W34ES-ZU	B11EGV	5831
W9	B2	3110
W9EP	BP2ES	3467
W9EXR-U	BPR2ES	2264
W9EX-U	BP2ES	3467
W9FP	BP2HS	7926
W9FP-L	BP2HS	7926
W9FP-UL	BP2HS	7926
W9LMR-US	BR2LM	5798

DENSO	NGK → STOCK No.	
W9LM-US	B2LM	1147
W9P	BP4	2911
W9-U	B2	3110
WA20M	BM6F	6221
WA20M-U	BM6F	6221
WA22M	BM7F	6421
WA22M-U	BM7F	6421
X16FSR-U	DR5HS	4623
X20FSR-U	DR6HS	4823
X20FS-U	D6HA	6512
X22EPR-U9	DPR7EA-9	5129
X22ESR-U	DR7ES	3123
X22ES-U	D7EA	7912
X24EPR-U9	DPR8EA-9	4929
X24EP-U9	DP8EA-9	9521
X24ES-GU	D8EVX	2850
X24ESR-U	DR8ES-L	2923
X24ES-U	D8EA	2120
X24FSR-U	DR8HS	5123
X24FS-U	D8HA	7112
X24GPR-U	DPR8Z	4730
X27EPR-U9	DPR9EA-9	5329
X27ESR-U	DR8ES	5423
X27ESR-ZU	DR9EIX	4772
X27ES-U	D9EA	2420
X27GPR-U	DPR9Z	4830
XE20HR-U9	LZKAR7A	6799
XU20EPR-U	DCPR6E	3481
XU22EPR-U	DCPR7E	3932
XU22EPR-ZU	DCPR7EVX	1179
XU24EPR-U	DCPR8E	4339
Y24FER-C	ER8EH	4011
Y27FER	ER9EH	5869
Y27FER-C	ER9EH	5869
Y31FER-C	ER10EH	2862
Z20ES-U	D6EA	7512

ENKER/BOSNA	NGK → STOCK No.	
F100C	B8HS	5510
F45CP	BP4HS	3611
F50C	B5HS	4210
F55CP	BP5HS	4111
F65CP	BP6HS	4511
F75C	B6HS	4510
F80C	B7HS	5110
F85CP	BP7HS	5111
FA50	B4L	3112
FA70	B6L	3212
FE100C	B9ES	2611
FE30C	B4ES	4129
FE45CP	BP5ES	6511
FE50C	B5ES	6410
FE55CP	BP5ES	6511
FE55CPD	BP5ET	2287
FE65CP	BP6ES	7811
FE65CPD	BP6ET	1263
FE70C	B6ES	7310
FE75C	B7ES	1111
FE80C	B8ES	2411
FE85CP	BP7ES	2412
FE95CP	BP8ES	2912
FET65CP	BP5EFS	3712
FET75CP	BP6EFS	3812
FS20	B2	3110
FS30	B4	3210
FS50CP	BP5S	3011
FS70	B6S	3510
FS75C	B7S	3710
FS80	B8S	3810
FSC50C	BM6A	5921
FSC50P	BPM6A	7021
FSC70P	BPM6A	7021
FSC75CP	BPM7A	7321
FT45CP	BP5FS	3412

ENKER/BOSNA	NGK → STOCK No.	
FT55CP	BP6FS	3512
FT85CP	BP7FS	3612
M30	AB2	3020
M60	A6	1010
M60	AB6	2910
M75	A7	1110
M75	AB7	3010
M80	A8	1210
MT55CP	AP6FS	2710
MT65CP	AP7FS	2127
SFE55CP	BCPR5ES	6130
SFE65CP	BCPR6ES	2330
SFE65CPD	BCP6ET	4563
SFE85CP	BCPR7ES	3330
SFE85CPD	BCP7ET	2078
T70	C6HSA	3228
T90	C7HSA	4629

EVINRUDE	NGK → STOCK No.	
204470091	BR7ES	5122
278000237	BR7ES	5122
278000608	BR7ES	5122
278000609	BR8ES	5422
MCBR10EG	BR10EG	3830
MCBR8EG	BR8EG	3130
MCBR8HS	BR8HS	4322
MCBR9EG	BR9EG	3230
MCBR9ES	BR9ES	5722

EYQUEM	NGK → STOCK No.	
1000	B8HS	5510
1000 MOTO	B8HS	5510
1000CM	B7S	3710
1000L	B8ES	2411
1000L MOTO	B8HS	5510
1000M	B8HS	5510
100M	B8HS	5510
1100	B9HS	5810
1100L	B8ES	2411
1100L MOTO	B8ES	2411
1150L	B9ES	2611
200	B4H	4110
202CT	B2LM	1147
300AM	B4L	3112
30AM	B4L	3112
400J	BR5FS	4123
406	BP6HS	4511
450JS	BPR4FS-15	2727
450L	B5ES	6410
480CS	BP5S	3011
500AM	B6L	3212
500C	B6S	3510
500CJT	BM6F	6221
500CM	B6S	3510
500CS	BP5S	3011
500CT	BM6A	5921
500J	BR6FS	4323
500JS	BPR4FS	1127
500M	B5HS	4210
502 MOTO	B4H	4110
502CT	B4LM	3410
505JS	BP5FS	3412
50AM	B6L	3212
50M	B5HS	4210
520CS	BP5S	3011
550CS	BP5S	3011
550JS	BPR5FS	2423
550LS	BP5ES	6511
550S	BP4HS	3611
580LS	BP5ES	6511
580S	BP4HS	3611
600CS	BP5S	3011
600JS	BPR6FS	2623
600L	B6ES	7310

EYQUEM	NGK → STOCK No.	
600LS	BP6ES	7811
600S	BP5HS	4111
700	B6HS	4510
700 MOTO	B6HS	4510
700CM	B6S	3510
700CTS	BPM6A	7021
705JS	BP7FS	3612
705L	B6ES	7310
705L MOTO	B6ES	7310
705S	BP6HS	4511
707LS	BP6ES	7811
70M	B6HS	4510
750	BP6HS	4511
750L	B6ES	7310
750LJS	BP6EFS	3812
750LS	BP6ES	7811
753LJS	BP6EFS	3812
755	B6HS	4510
755 MOTO	B6HS	4510
755CJT	BM7F	6421
755CM	B6S	3510
755CT	BM7A	6521
755L	B6ES	7310
755L MOTO	B6ES	7310
755LJS	BP6EFS	3812
755LS	BP6ES	7811
755LS MOTO	BP6ES	7811
755M	B6HS	4510
755S	BP6HS	4511
75LM	B6ES	7310
75M	B6HS	4510
775SX	BP6HS	4511
775X	B6HS	4510
800L	B6ES	7310
800LJS	BP6EFS	3812
800LS	BP6ES	7811
800LS MOTO	BP6ES	7811
802L	B6ES	7310
803LJS	BP6EFS	3812
805L	B6ES	7310
805L MOTO	B6ES	7310
805LJS	BP7EFS	3526
805LJSP	BP7EFVX	3344
805LP	B7EVX	6934
850	B7HS	5110
850 MOTO	B7HS	5110
850LS	BP7ES	2412
C32	B5HS	4210
C32LS	BP5ES	6511
C32S	BP5HS	4111
C42LJS3	BP6EFS	3812
C42S	BP6HS	4511
C52LS	BP5ES	6511
C62	B7HS	5110
C62LJS	BP6EF	4666
C62LJS	BP6EFS	3812
C62LS	BP6E	7529
C62LS	BP6ES	7811
C62LS3X	BP5ET	2287
C62S	BP7HS	5111
C72LJS	BP7EFS	3526
C72LS	BP7ES	2412
C72LS3X	BP6ET	1263
C82LJS	BP7EFS	3526
C82LS	BP7ES	2412
C92LS	BP8ES	2912
D1000	D8HA	7112
D1000 MOTO	D8HA	7112
D1000L	D9EA	2420
D1050L	D9EA	2420
D755 MOTO	D6HA	6512
D775	D6HA	6512
D800L	D7EA	7912
D800L MOTO	D7EA	7912

EYQUEM	NGK → STOCK No.	
D900L	D8EA	2120
FC52LS	BCP5ES	7496
FC52LS	BCP5ES	7496
FC58LS	BCP6ES	4930
FC62LS	BCP6ES	4930
FC62LS2	BCP6ES	4930
FC62LS3	BCP6ET	4563
FC62LS3X	BCP6ET	4563
FC72LS	BCP7ES	5030
FC82LS	BCP7ES	5030
FC82LS1	BCP7ES	5030
FC82LS2	BCP7ES	5030
K200M	A6	1010
K200M	AB6	2910
K300M	A6	1010
K300M	AB6	2910
K500M	A6	1010
K500M	AB6	2910
K550JS	AP6FS	2710
K600M	A6	1010
K600M	AB6	2910
K750M	A7	1110
K750M	AB7	3010
KC62JS	AP6FS	2710
R1000	BR8HS	4322
R1000L	BR8ES	5422
R850	BR7HS	4122
RC42S	BPR6HS	7022
RC52LZ3EX	BUR5ET	3377
RC52LZE	ZGR5A	5839
RC58LZ3EX	BUR6ET	3172
RC62HJSDP	PTR5A-10	5055
RC62LJS	BPR6EFS	3623
RC62LS	BPR6ES	7822
RC62LS5	BPR6ES-11	4824
RC62S	BPR7HS	6422
RC82LS	BPR7ES	2023
RFC42LS	BKR5E	7938
RFC42LS2E	BKR5EK	7956
RFC50LZ2E	BKR5EK	7956
RFC52LS	BCPR5ES	6130
RFC52LS3	BKR6EKUB	3584
RFC52LS5	BKR5E-11	6953
RFC52LZE	ZFR5F	5165
RFC52LZK	BKR5EZ	7642
RFC58LS	BKR6E	6962
RFC58LS2E	BKR6EK	2288
RFC58LS3	BCPR6ET	2197
RFC58LS5	BKR6E-11	2756
RFC58LSP	BKR6EZ	4619
RFC58LZ	BKR6EY	3696
RFC58LZ2	BKR6EKC	2848
RFC58LZ3EX	BKUR6ET	6437
RFC58LZP	PFR6B	3500
RFC58LZDP	PFR6B	3500
RFC58LZE5	ZFR6F-11	4291
RFC62LS3X	BCPR6ET	2197
RFC62LS5	BCPR6ES-11	7121
RFC62LZ3X	BKUR7ET	7873
RFC82LS	BCPR7ES	3330
RFC82LS5	BCPR7ES-11	1095
RFN52HZ	LFR5B	7113
RFN52LZ	BKR5EZ	7642
RFN58HZ	LFR6B	6677
RFN58LZ	BKR6EZ	4619
T850	C7HSA	4629
XKC62JS	APR6FS	2922
FIAT	NGK → STOCK No.	
46144731	DCPR8E	4179
46229251	BP6ES	7811
46417010	BKR6E	6962
46449690	BKR6EKPA	2513
46463801	BKR6EKC	2848

FIAT	NGK → STOCK No.	
46472021	BKR6EKC	2848
46475164	BCPR7ET	2164
46521529	BKR6EKPA	2513
46521530	PMR7A	4259
46531917	DCPR8EKC	7168
55188857	DCPR7E-N-10	4983
55190788	ZKR7A-10	1691
5894585	BPR7ES	2023
5894586	BKR6E	6962
5894588	BCPR7ES	3330
5896824	BKR6EKC	2848
5984036	BPR6ES	7822
60504563	BP6ES	7811
60512848	BCP6ET	4563
60512929	B7ES	1111
60569957	PFR6B	3500
60597490	BCP7ES	5030
60800325	BPR7ES	2023
60806024	BP6ET	1263
60810689	PFR6B	3500
71711638	BKR6E	6962
71711639	BPR6ES	7822
71711640	BPR6ES	7822
71711806	BPR6ES	7822
71711808	BKR6E	6962
7546519	BKR6E	6962
7554436	BPR7ES	2023
7554442	BP6ES	7811
7554444	BPR6ES	7822
7554445	BP6HS	4511
7565476	BR8ES	5422
7686643	BP6ET	1263
7760381	BPR7ES	2023
7760382	BPR6ES	7822
7760383	BKR6E	6962
7760384	BCPR7ES	3330
7769243	BCPR6ET	2197
7772453	BKR6E	6962
7772515	BPR7ES	2023
7910247204	BPR6EFS	3623
7FYSR	BPR7ES	2023
7FYSSR	BPR7ES	2023
7GBYSR4	BCPR7ET	2164
7GYSSR	BCPR7ES	3330
9614738680	BKR6EK	2288
9618494580	BKR5EK	7956
9618571880	BKR6EKC	2848
9619624580	BKR5EK	7956
9FYSSR	BPR6ES	7822
9GYSSR	BKR6E	6962
FORD	NGK → STOCK No.	
1032705	BKR5EKUP	2890
1077002	PTR5A-10	5055
1088847	TR5A-10	0005
1202935	PLTR6A-10G	3587
1204572	PTR6F-13	7569
1219309	TR5B-13	4559
1120170	PZFR5D-11	7968
1120820	APR6FS	2922
1120830	BCPR6ES	6130
1120831	BCPR6ES	6130
1120836	BPR6ES	7822
1233897	PTR5A-10	5055
1307093	PTR6F-13	7569
1315691	ITR6F13	4477
1369704	TR6AP-13	5809
1M50 12405 CA	PLTR6A-10G	3587
3SJA 12405 AB	ITR6F13	4477
5M5G 12405 AA	TR6AP-13	5809
6M8G 12405 BB	ILTR5A-13G	3811
95VW 12405 DA	BKR5EKUP	2890
AGFS22FE13J	PTR6F-13	7569
AYFS22FE1J	PLTR6A-10G	3587

FORD	NGK → STOCK No.	
AYFS32CJ	TR5B-13	4559
AYFS32BB	ILTR5A-13G	3811
YM21 12405 AA	PZFR5D-11	7968
YN2F 12405 A2A	TR5B-13	4559
YN2J 12405 AA	TR5B-13	4559
FUJI	NGK → STOCK No.	
065-01400-10	B4	3210
065-01400-20	B4H	4110
065-01400-31	B6HS	4510
065-01400-41	B7HS	5110
065-01400-50	B7ES	1111
065-01400-60	B6HS	4510
065-01400-80	B4	3210
065-01400-90	B7HS	5110
065-01401-00	B6ES	7310
065-01401-10	B4H	4110
065-01401-30	B7ES	1111
065-01401-40	B8ES	2411
065-01401-50	BR6HS	3922
065-01401-60	B9ES	2611
065-01401-70	BP4HS	3611
065-01401-80	BR7HS	4122
065-01401-90	BP4HS	3611
065-01402-10	BP6HS	4511
065-01402-20	B10EVX	7335
065-01402-30	BP5ES	6511
065-01402-40	BR8ES	5422
065-01402-50	BR9ES	5722
065-01402-60	BP5HS	4111
065-01402-70	BPR4HS	7823
065-01402-80	BPR5ES	7422
065-01403-00	BP6ES	7811
065-01403-10	BR4HS	3322
065-01403-20	BPR4HS-10	5024
065-01403-30	BPR4ES	7222
065-01403-40	BP2HS	7926
065-01403-60	BP2HS	7926
065-01403-70	BM4A	5628
065-01403-80	BMR4A	5728
065-01403-90	BP4HS	3611
065-01404-20	BPR6HS	7022
065-01404-30	BPM6A	7021
065-01404-60	BM6A	5921
065-01404-70	BMR6A	7421
065-01405-00	B9HS	5810
065-01405-10	BR6HS	3922
932-05410-00	B5ES	6410
982-05486-00	B6ES	7310
GUTBROD	NGK → STOCK No.	
000.80.071	B6HS	4510
000.81.345	B4LM	3410
090.33.668	B4H	4110
090.50.805	BPR6ES	7822
092.05.406	BR2LM	5798
092.05.900	B6S	3510
092.13.609	BR4LM	4133
092.25.081	BP5ES	6511
092.32.278	BCPR5ES	6130
092.38.072	BPR5ES	7422
092.38.467	BM6A	5921
092.40.182	BPR5EFS	2223
HARLEY-DAVIDSON	NGK → STOCK No.	
10R12A	DCPR9E	2641
3	B6L	3212
3-4	BP5S	3011
4	B6L	3212
4-5	BP7HS	5111
4R	B6L	3212
4R5	BPR7HS-10	1092
5	B6S	3510
5A6	BP5ES	6511

HARLEY-DAVIDSON	NGK → STOCK No.	
5R6	BPR5ES	7422
5R6A	BPR5ES-11	4424
5RL	ZGR5C	6334
6R12	DCPR7E	3932
8	B10EGV	5927
HONDA	NGK → STOCK No.	
12290-PNE-0030	ZFR6K-11	6711
12290-PRB-A01	IFR7G-11KS	7746
12290-RMX-003	ILFR6J-11K	4458
12290-RMX-013	ILFR6J-11K	4458
31911-MBW-E11	IMR8C-9H	3653
31912-MBW-E110	IMR9C-9H	6777
31912-MCW-0030	IMR9B-9H	4888
31912-MEL-003	IMR9C-9HES	5766
31915-ZOH-003	CMR5H	5799
31916-ZOH-003	CMR6H	3365
31918-MEB-671	IFR8H11	5068
94701-00408	CR9EIA-9	6289
98049-58716	ER8EH	4011
98049-59716	ER9EH	5869
98049-60716	ER10EH	2862
98052-56471	CM-6	5812
98056-17U	IFR6L11	3678
98056-55777	CR5HSB	6535
98056-56713	C6HSA	3228
98056-56716	CR6HS	7023
98056-56718	CR6HSA	2983
98056-57713	C7HSA	4629
98056-57716	CR7HS	7223
98056-57718	CR7HSA	4549
98056-58713	C8HSA	6821
98056-58716	CR8HS	7423
98056-58718	CR8HSA	2086
98059-55916	CR5EH-9	6689
98059-57916	CR7EH-9	3486
98059-58916	CR8EH-9	5666
98059-59916	CR9EH-9	7502
98059-5991U	IMR9A-9H	6966
98059-599U	CR9EHI-9	6419
98061-58616	DPR8Z	4730
98061-59616	DPR9Z	4830
98066-54716	DR4HS	3326
98066-55716	DR5HS	4623
98066-56716	DR6HS	4823
98066-56717	D6HA	6512
98066-58716	DR8HS	5123
98066-58717	D8HA	7112
98069-38716	DR8ES-L	2923
98069-55916	DPR5EA-9	2887
98069-56717	D6EA	7512
98069-56916	DPR6EA-9	5531
98069-57716	DR7ES	3123
98069-57717	D7EA	7912
98069-5771P	DR7EA	7839
98069-57911	DPR7EA-9	5129
98069-57912	DPR7EVX-9	7682
98069-57916	DPR7EA-9	5129
98069-5791U	IJR7A9	7901
98069-58716	DR8ES	5423
98069-58717	D8EA	2120
98069-58912	DPR8EIX-9	2202
98069-58916	DPR8EA-9	4929
98069-59717	D9EA	2420
98069-59912	DPR9EIX-9	5545
98069-59916	DPR9EA-9	5329
98069-5991F	DPR9EIX-9	5545
98073-52710	B2	3110
98073-54710	B4	3210
98073-54740	BM4A	5628
98073-54744	BMR4A	5728
98073-54776	BPMR4A	6028
98073-54944	BPMR4A-10	6328
98073-56740	BM6A	5921

HONDA	NGK → STOCK No.
98073-56741	BPM6A 7021
98073-56744	BMR6A 7421
98073-56944	BPMR6A-10 1029
98076-52711	BP2HS 7926
98076-54710	B4H 4110
98076-54711	BP4HS 3611
98076-54716	BR4HS 3322
98076-54717	BPR4HS 7823
98076-54746	BR4HS 3322
98076-54747	BPR4HS 7823
98076-54914	BPR4HS-10 5024
98076-54944	BPR4HS-10 5024
98076-55711	BP5HS 4111
98076-55716	BR5HS 3722
98076-55717	BPR5HS 6222
98076-55719	BP5HS 4111
98076-55747	BPR5HS 6222
98076-56711	B6HS 4510
98076-56715	BPR6HSA 4632
98076-56716	BR6HS 3922
98076-56717	BPR6HS 7022
98076-56719	BP6HS 4511
98076-5671G	BR6HSA 4296
98076-56741	B6HS 4510
98076-56747	BPR6HS 7022
98076-56917	BPR6HS-10 2623
98076-57710	B7HS 5110
98076-57711	BP7HS 5111
98076-57716	BR7HS 4122
98076-57717	BPR7HS 6422
98076-57740	B7HS 5110
98076-58710	B8HS 5510
98076-58711	BP8HS 2630
98076-58716	BR8HS 4322
98076-58717	BPR8HS 3725
98076-5871G	BR8HSA 5539
98076-58740	B8HS 5510
98076-58747	BPR8HS 3725
98076-59710	B9HS 5810
98076-59716	BR9HS 4522
98079-5414G	ZFR4F-11 4043
98079-54817	BPR4ES 7222
98079-54846	BPR4ES 7222
98079-55145	BPR5ES-11 4424
98079-55146	BPR5EY-11 3028
98079-55147	BCPR5ES-11 3524
98079-55148	BCPR5E-11 1273
98079-5514E	BKR5E-11 6953
98079-5514H	PFR5G-11 2647
98079-5514P	ZFR5J-11 5584
98079-5515G	ZFR6F-11 4291
98079-5515U	IFR5L11 6502
98079-5517U	FR6BI-11 4709
98079-5517V	IFR5G-11K 3107
98079-55810	B5ES 6410
98079-55811	BP5ES 6511
98079-55816	BR5ES 4722
98079-55817	BPR5ES 7422
98079-55840	B5ES 6410
98079-55841	BP5ES 6511
98079-55844	BP5EVX 5470
98079-55846	BPR5ES 7422
98079-55847	BR5ES 4722
98079-55941	BP5EY 7327
98079-55946	BPR5EY 2828
98079-56145	BPR6ES-11 4824
98079-56146	BPR6EY-11 4228
98079-56147	BCPR6ES-11 7121
98079-56148	BCPR6E-11 3132
98079-56149	BCPR6EY-11 3720
98079-5614E	BKR6E-11 2756
98079-5614G	ZFR6F-11 4291
98079-5614H	PFR6G-11 5555
98079-5614J	BKR6E-N-11 5724

HONDA	NGK → STOCK No.
98079-5614N	PZFR6F-11 3271
98079-5614P	ZFR6J-11 5585
98079-5615G	ZFR6F-11 4291
98079-5615N	PZFR6F-11 3271
98079-5617U	IFR6L11 3678
98079-56810	B6ES 7310
98079-56811	BP6ES 7811
98079-56817	BR6ES 4922
98079-56840	B6ES 7310
98079-56841	BP6ES 7811
98079-56844	BP6EVX 5832
98079-56846	BPR6ES 7822
98079-56847	BR6ES 4922
98079-56941	BP6EY 7727
98079-56946	BPR6EY 6427
98079-57145	BPR7ES-11 7226
98079-5714E	BKR7E-11 1283
98079-5714G	ZFR7F-11 2975
98079-5714H	PFR7G-11 2380
98079-5715H	PFR7G-11 2380
98079-571BV	IFR7G-11KS 7746
98079-57614	B7EVX 6934
98079-57810	B7ES 1111
98079-57811	BP7ES 2412
98079-57816	BR7ES 5122
98079-57840	B7ES 1111
98079-57841	BP7ES 2412
98079-57846	BPR7ES 2023
98079-57847	BR7ES 5122
98079-57876	BR7ES 5122
98079-57877	BR7ES 5122
98079-57946	BPR7EY 1144
98079-58644	B8EVX 7051
98079-58646	BR8EIX 5044
98079-58648	B8EG 3430
98079-58649	BR8EG 3130
98079-58678	B8EG 3430
98079-58679	BR8EG 3130
98079-58810	B8ES 2411
98079-58816	BR8ES 5422
98079-58819	BR8ECS 3972
98079-58840	B8ES 2411
98079-58842	B8ECS 2821
98079-58845	BR8ECM 3035
98079-58846	BR8ES 5422
98079-58847	BPR8ES 3923
98079-58870	B8ES 2411
98079-58876	BR8ES 5422
98079-59644	B9EVX 7254
98079-59646	BR9EIX 3981
98079-59648	B9EG 3530
98079-59649	BR9EG 3230
98079-59678	B9EG 3530
98079-59679	BR9EG 3230
98079-59810	B9ES 2611
98079-59811	B9ES 2611
98079-59816	BR9ES 5722
98079-59819	BR9ECS 3570
98079-59842	B9ECS 7058
98079-59845	BR9ECM 3252
98079-59847	BR9ES 5722
98079-59870	B9ES 2611
98079-59876	BR9ES 5722
98079-60616	BR10EIX 6801
98079-60646	BR10EIX 6801
98079-60648	B10EG 3630
98079-60649	BR10EG 3830
98079-60676	BR10EIX 6801
98079-60678	B10EG 3630
98079-60679	BR10EG 3830
98079-60817	BR10ES 4832
98079-60819	BR10ECS 5880
98079-60845	BR10ECM 4234
9807B-561BW	IZFR6K-11S 5266

HONDA	NGK → STOCK No.
9807B-5615W	IZFR6K11 6994
9807B-5617W	IZFR6K11 6994
98179-56841	BP6ES 7811
ISKRA	NGK → STOCK No.
F100RS	BR8HS 4322
F100S	B8HS 5510
F20	B4H 4110
F50	B5HS 4210
F55PS	BP5HS 4111
F65PRS	BPR6HS 7022
F65PS	BP6HS 4511
F70	B5HS 4210
F75RS	BR6HS 3922
F75S	B6HS 4510
F805RS	BR7HS 4122
F80S	B7HS 5110
F85PS	BP7HS 5111
F95PS	BP7HS 5111
FE100RS	BR9ES 5722
FE100S	B9ES 2611
FE145P	BP9ES 7526
FE155P	BP8EVX 2671
FE45P	BP5E 4669
FE50	B5ES 6410
FE55LRS	ZGR5A 5839
FE55LTXS	BUR5ET 3377
FE55LXS	ZGR5A 5839
FE55PRS	BPR5ES 7422
FE55PS	BP5ES 6511
FE55PTS	BP5ET 2287
FE65LTXS	BUR6ET 3172
FE65PP2	BP6EVX 5832
FE65PRP2	BPR6ES 7822
FE65PRS	BPR6ES 7822
FE65PS	BP6ES 7811
FE65PTS	BP6ET 1263
FE75RS	BR7ES 5122
FE75S	B7ES 1111
FE80RS	BR8ES 5422
FE80S	B8ES 2411
FE85PRS	BPR7ES 2023
FE85PS	BP7ES 2412
FET55PRS	BPR5EFS 2223
FET55PS	BP5EFS 3712
FET65PRS	BPR6EFS 3623
FET65PS	BP6EFS 3812
FET75PS	BP7EFS 3526
FS50KR	BR2LM 5798
FS70	B6S 3510
FS70C	BPM6A 7021
FS75	B7S 3710
FS75C	BPM7A 7321
FT65PS	BP6FS 3512
FUT55PRP-13	PTR5A-10 5055
M60	A6 1010
M60	AB6 2910
M75	A7 1110
M75	AB7 3010
M80	A8 1210
MT65PRS	APR6FS 2922
MT65PS	AP6FS 2710
SFE55LRS	ZFR5F 5165
SFE55LXS	ZFR5F 5165
SFE55PRS	BCPR5ES 6130
SFE55PS	BKR5E 7938
SFE55PS	BCP5ES 7496
SFE65LDRS	BKR5EK 7956
SFE65LRS	ZFR6A-11 1041
SFE65LTXS	BKUR6ET 6437
SFE65LXS	ZFR6A-11 1041
SFE65PDRS	BKR6EKC 2848
SFE65PRS	BKR6E 6962
SFE65PS	BKR6ES 3783

ISKRA	NGK → STOCK No.
SFE65PS	BCP6ES 4930
SFE65PTRS	BCPR6ET 2197
SFE65PTS	BCP6ET 4563
SFE85LDRS	BKR6EK 2288
SFE85LTRS	BKUR7ET 7873
SFE85PR5	BKR7E 6097
SFE85PRS	BCPR7ES 3330
SFE85PS	BCP7ES 5030
SFE85PTRS	BCPR7ET 2164
SFE85PTS	BCP7ET 2078
T90	C7HSA 4629
TWE85PRS	DCPR8E 4179
ISOLATOR	NGK → STOCK No.
6B	BP6HS 4511
7A	B6HS 4510
7B	BP6HS 4511
7D	BP6ES 7811
A5D	BP7EFS 3526
A7D	BP6EFS 3812
FM14-145/2	BP5ES 6511
FM14-175/2	BP6ES 7811
FM14-200/2	BP6ES 7811
FM14-225/2	BP7ES 2412
M14-145	B5HS 4210
M14-175	B6HS 4510
M14-175/2	B6ES 7310
M14-225	B7HS 5110
M14-240	B8HS 5510
M14-260	B9HS 5810
M14-95	B4H 4110
M18-225	A7 1110
M18-225	AB7 3010
M18-240	A7 1110
M18-240	AB7 3010
PM14-225	BP7HS 5111
U7D	BCP6ES 4930
U8D	BCP5ES 7496
ZM14-260	B8HS 5510
ISUZU	NGK → STOCK No.
5-81380001-0	BPR5ES 7422
5-81380003-0	BP5EVX 5470
5-81380004-0	BP6EVX 5832
5-81380012-0	BP5EY 7327
5-81380013-0	BP6EY 7727
8-94120560-0	BPR5ES-11 4424
8-94217232-0	BPR6ES-11 4824
8-94219943-0	BPR6ES 7822
8-94328373-0	BKR7E-11 1283
8-97012928-0	BKR6E 6962
9-82513103-0	BP6ES 7811
9-82513105-0	B6ES 7310
9-82513106-0	BP5ES 6511
9-82513107-0	B5ES 6410
9-82513113-0	B7ES 1111
ITALJET	NGK → STOCK No.
94004	BR7HS 4122
94015	DR8EA 7162
94025	BR8HS 4322
94029	BR9ES 5722
94032	CR7E 4578
JAGUAR	NGK → STOCK No.
JC2S 46895	TR6AP-13E 4968
JAPCAR	NGK → STOCK No.
123762	BP5ES 6511
123770	BP6ES 7811
123778	BPR5ES 7422
123789	BPR6ES 7822
123801	BPR7ES 2023
123825	BPR5ES-11 4424

JAPCAR	NGK → STOCK No.	
123834	BPR6ES-11	4824
123887	BPR5ES	7422
123899	BPR6ES	7822
123908	BPR7ES	2023
123932	BPR5ES-11	4424
123940	BPR6ES-11	4824
123993	BPR7ES-11	7226
123996	BR7ES	5122
124040	BPR7ES-11	7226
124144	BPR6ES-11	4824
166573	BPR6ES	7822
167605	PF6J-11	2743
170006	BPR6ES-11	4824
172988	BPR5ES	7422
173939	BKR6E-11	2756
177391	BKR6E-11	2756
207417	PF6J-11	2743
239214	PF5J-11	4642
277200	BKR5E-11	6953
277201	BKR5E-11	6953
279427	PF5J-11	4045
JEEP	NGK → STOCK No.	
SP000ZFR5N	ZFR5N	7917
JENN FENG	NGK → STOCK No.	
9295-331501	BPMR7A	4626
JG - see CHINESE BRANDS		
JIGUANG - see CHINESE BRANDS		
JOHNSON	NGK → STOCK No.	
204470091	BR7ES	5122
278000237	BR7ES	5122
278000608	BR7ES	5122
278000609	BR8ES	5422
MCBR10EG	BR10EG	3830
MCBR8EG	BR8EG	3130
MCBR8HS	BR8HS	4322
MCBR9EG	BR9EG	3230
MCBR9ES	BR9ES	5722
K & N	NGK → STOCK No.	
XP422	PF6G-11	5555
KAWASAKI	NGK → STOCK No.	
(E)92070-1063	BR9EG	3230
(E)92070-1064	BR8EG	3130
(E)92070-1165	DR7EA	7839
(E)92070-1173	BR10ES	4832
(E)92070-2077	BPR5ES	7422
92070-0010	R6918B-9	2954
92070-0016	BR9ECMVX	2434
92070-1142	C9E	7499
92070-1146	D6EA	7512
92070-1241	R6252K-105	2741
92070-1264	CR9EK	4548
92070-1265	CR8EK	3478
92070-1266	CR9E	6263
92070-2052	BP4HS	3611
92070-2061	BPR4HS	7823
92070-2070	BR4HS	3322
92070-2108	BPMR6A	6726
92070-2110	BPR2ES	2264
92070-7004	BPR4ES	7222
E92070-0001	B7HS	5110
E92070-014	B6ES	7310
E92070-036	B9HS	5810
E92070-037	B8ES	2411
E92070-054	B9ES	2611
E92070-1002	B7ES	1111
E92070-1014	BP8ES	2912
E92070-1019	DR8ES	5423

KAWASAKI	NGK → STOCK No.	
E92070-1022	BR8ES	5422
E92070-1024	BP6ES	7811
E92070-1025	BPR6ES	7822
E92070-1026	BP7ES	2412
E92070-1027	BPR7ES	2023
E92070-1034	D9EA	2420
E92070-1044	BPR8ES	3923
E92070-1053	BR9ES	5722
E92070-1057	B8EG	3430
E92070-1058	B9EG	3530
E92070-1065	DPR8EA-9	4929
E92070-1068	DPR9EA-9	5329
E92070-1109	BR9ES	5722
E92070-1113	DR7ES	3123
E92070-1114	C6HSA	3228
E92070-1116	DR8ES-L	2923
E92070-1125	DPR7EA-9	5129
E92070-1132	B10EG	3630
E92070-1133	BR10EG	3830
E92070-1138	DPR6EA-9	5531
E92070-1143	CR9E	6263
E92070-1145	CR9EK	4548
E92070-1154	CR7HSA	4549
E92070-1155	CR8HSA	2086
E92070-1158	CR8EK	3478
E92070-1169	CR8E	1275
E92070-1173	BR10ES	4832
E92070-1178	BP5ES	6511
E92070-1186	B10EVX	7335
E92070-1189	DR9EA	3437
E92070-1199	DR8EA	7162
E92070-1209	CR7E	4578
E92070-1212	B9EVX	7254
E92070-1250	DPR5EA-9	2887
E92070-1254	CR9EKPA	7785
E92070-2072	BMR4A	5728
E92070-2100	BMR2A	7677
KIA	NGK → STOCK No.	
OK55818110	PF6N-11	3546
KLG	NGK → STOCK No.	
F100	B8HS	5510
F20	B4H	4110
F220	B9HS	5810
F50	B5HS	4210
F55P	BP5HS	4111
F65P	BP6HS	4511
F70	B5HS	4210
F75	B6HS	4510
F80	B7HS	5110
F85P	BP6HS	4511
F95P	BP7HS	5111
FA50	B4L	3112
FA70	B6L	3212
FE100	B8ES	2411
FE125P	BP6ES	7811
FE135P	BP7ES	2412
FE145P	BP8ES	2912
FE155P	BP8ES	2912
FE220	B9ES	2611
FE30	B4ES	4129
FE45P	BP5ES	6511
FE50	B5ES	6410
FE55P	BP5ES	6511
FE65P	BP6ES	7811
FE70	B5ES	6410
FE75	B6ES	7310
FE80	B7ES	1111
FE85P	BP6ES	7811
FE95P	BP7ES	2412
FS100	B8S	3810
FS20	B2	3110
FS30	B4	3210

KLG	NGK → STOCK No.	
FS35P	BP4	2911
FS45P	BP5S	3011
FS50	B6S	3510
FS70	B6S	3510
FS75	B7S	3710
FS75H	B7S	3710
FT55P	BP5FS	3412
FT65P	BP5FS	3412
FT85P	BP6FS	3512
FT95P	BP7FS	3612
GT4S	BP5S	3011
GT5	BP5HS	4111
GT5L	BP5ES	6511
GT6	BP6HS	4511
GT6L	BP6ES	7811
GT6T	AP6FS	2710
GT7	BP7HS	5111
GT7L	BP7ES	2412
GT8L	BP8ES	2912
M30	AB2	3020
M50	A6	1010
M50	AB6	2910
M60	A6	1010
M60	AB6	2910
M75	A7	1110
M75	AB7	3010
M80	A8	1210
MT75P	AP6FS	2710
MT85P	AP6FS	2710
T90	C7HSA	4629
TW270	D6HA	6512
TW275	D6HA	6512
TW280	D8HA	7112
TWE270	D8EA	2120
TWE275	D9EA	2420
KTM	NGK → STOCK No.	
590390-93100	DCPR8E	4179
515390-93000	BR9ECMVX	2434
610390-93000	DCPR8E	4339
611390-93000	KR8DI	4742
780390-93000	LKAR8A-9	4786
KUBOTA	NGK → STOCK No.	
07909-2225-0	BM6A	5921
07909-2226-0	BM7A	6521
10202-6771-6	AB6	2910
10261-6771-6	G2Z	3320
12268-6771-1	BP2ES	3467
12366-6771-6	BR4HS	3322
12392-6771-1	BP5ES	6511
12647-6771-1	BPR6HS	7022
12681-6774-1	BR5ES	4722
12691-6771-1	BCP4ES-11	1086
12863-6771-1	BP5ES	6511
12866-6771-1	BP5ES	6511
12992-6771-1	BPR5ES	7422
13078-6771-6	BP6ES	7811
13157-6771-2	BM4A	5628
13211-6771-6	B4	3210
13281-6771-6	B4H	4110
13301-6771-6	AB2	3020
13373-6774-1	BMR4A	5728
13374-6774-1	BPR4HS	7823
13375-67740	BP5ES	6511
13375-6774-1	BPR4HS-10	5024
13401-6771-6	B6S	3510
13412-6771-6	B7S	3710
13451-6771-6	B6HS	4510
13581-6771-6	B7HS	5110
13582-6771-1	B6HS	4510
13641-6771-1	B4H	4110
13901-6771-6	BP6HS	4511
13979-6771-1	BP4HS	3611

LD - see CHINESE BRANDS		
LG - see CHINESE BRANDS		
LIXIN - see CHINESE BRANDS		
LODGE	NGK → STOCK No.	
15HLNY	BP6ES	7811
25HLD	BGP6ET	4563
25HLNY	BP7ES	2412
25XL	BP6ES	7811
2H	B7HS	5110
2H12	D8HA	7112
2HA	B6S	3510
2HL	B7ES	1111
2HL10	C7HSA	4629
2HLD	BGP6ES	4930
2HL-E	B7ES	1111
2HLN	B7ES	1111
2HLNY	BP7ES	2412
2HN	B7HS	5110
2HNY	BP7HS	5111
2H-TNY	AP7FS	2127
2HTY	BP6FS	3512
2HV	A8	1210
2XL	BP6ES	7811
3HAN	B8S	3810
3HLN	B8ES	2411
3HLNY	BP7ES	2412
3HN	B8HS	5510
3HNY	BP8ES	2912
4HLNY	BP8ES	2912
5HLNY	BP8ES	2912
BAN	B4	3210
BANY	BP5S	3011
BBANY	BP4	2911
BBL	A6	1010
BBL	AB6	2910
BBNY	BP4HS	3611
BLN	B4ES	4129
BLNY	BP5ES	6511
BLTY	BPR5EFS	2223
BN	B4H	4110
B-TY	BP5FS	3412
BV	AB2	3020
CAN	B6S	3510
CANB	BPM6A	7021
CANC	BM6A	5921
CL14	B5ES	6410
CLN	B6ES	7310
CLN14P	B5ES	6410
CLNH	B5ES	6410
CLNY	BP5ES	6511
CN	B5HS	4210
CNY	BP5HS	4111
CSN	B4L	3112
CTY	BP5FS	3412
CV	A6	1010
CV	AB6	2910
H	B6HS	4510
H12	D6HA	6512
H18	A7	1110
H18	AB7	3010
HA	B7S	3710
HAN	B7S	3710
HAN/M	B7S	3710
HB12	D6HA	6512
HBAN	B6S	3510
HBL12	D8EA	2120
HBLN	B5ES	6410
HBN	B5HS	4210
HBSN	B6L	3212
HBTNY	AP6FS	2710
HBTY	BP5FS	3412
HBV	A6	1010

LODGE	NGK → STOCK No.
HBV	AB6 2910
HL	B6ES 7310
HL12	D9EA 2420
HL14	B6ES 7310
HL-E	B6ES 7310
HLN	B6ES 7310
HLNP	B6ES 7310
HLNY	BP6ES 7811
HN	B6HS 4510
HNY	BP6HS 4511
HT14	BP5FS 3412
HT18	AP6FS 2710
HTNY	AP6FS 2710
H-TY	BP6FS 3512
HV	A7 1110
HV	AB7 3010

MARCHAL/VALEO	NGK → STOCK No.
17C	A7 1110
17C	AB7 3010
19C	A7 1110
19C	AB7 3010
19E	A7 1110
19E	AB7 3010
19L	A7 1110
19L	AB7 3010
2/13	A8 1210
2/32	B8HS 5510
2/32H	B8ES 2411
2/33	B8HS 5510
2/33H	B7ES 1111
20C	A6 1010
20C	AB6 2910
20E	A6 1010
20E	AB6 2910
20L	A6 1010
20L	AB6 2910
21C	A6 1010
21C	AB6 2910
21E	A6 1010
21E	AB6 2910
21L	A6 1010
21L	AB6 2910
22L	AB2 3020
22LM	AB2 3020
23F	A6FS 2210
34/5HS	BP6ES 7811
34C	B7S 3710
34CM	B7S 3710
34HS	B7ES 1111
34HSM	B7ES 1111
34S	B7HS 5110
35	B6HS 4510
35/1	BP6HS 4511
35/1B	BP6HS 4511
35/1D	BP6HS 4511
35/36D	B6HS 4510
35/36P	B6HS 4510
35/36R	B6HS 4510
35B	B6HS 4510
35C	B6S 3510
35CM	B6S 3510
35HA	BP6ES 7811
35HS	B6ES 7310
35M	B6HS 4510
35P	B6HS 4510
36	B5HS 4210
36B	B5HS 4210
36C	B4 3210
36CM	B4 3210
36D	B5HS 4210
36HS	B5ES 6410
36M	B5HS 4210
36P	B5HS 4210

MARCHAL/VALEO	NGK → STOCK No.
37S	B5HS 4210
4N	B7HS 5110
5H	B7ES 1111
5N	BP6HS 4511
5N CYCLO	BP6HS 4511
64H	BP7ES 2412
67HP	B8EVX 7051
6H	BP7ES 2412
6N	BP5HS 4111
70H	BP6ES 7811
76H	BP5ES 6511
7H	BP6ES 7811
84H	BP5ES 6511
88N	B5HS 4210
8H	BP6ES 7811
9H	BP5ES 6511
C64H	BP6EFS 3812
C68H	BP6EFS 3812
C7H	BP6EFS 3812
F70H	BCP7ES 5030
F74H	BCP6ES 4930
F80H	BCP7ES 5030
GT34	BP7HS 5111
GT34/2H	BP6ES 7811
GT34/5	BP6HS 4511
GT34/5D	BP6HS 4511
GT34/5H	BP6ES 7811
GT34/5HA	BP6ES 7811
GT34/5HD	BP6ES 7811
GT34D	BP7HS 5111
GT34H	BP7ES 2412
GT34HD	BP6ES 7811
GT35	BP5HS 4111
GT35D	BP5HS 4111
GT35H	BP5ES 6511
GT35HD	BP5ES 6511
H32RG	B9EG 3530
H33RG	B8EG 3430
H34F	B8ES 2411
HA32/2	B8ES 2411
HA32RS	B9EG 3530
HF34	B7ES 1111
HF34F	B8ES 2411
RR31HS	B10EG 3630
RR32HS	B9EGV 5827
RR33HSS	B8EGV 5627
SCGT34/5H	BP6EFS 3812
SCGT35H	BP6EFS 3812
V36A	B5HS 4210
V6N SOLEX	B5HS 4210

MARELLI	NGK → STOCK No.
7LCR	BKR6E 6962
7LPR	BKR6E 6962
8LCR	BCPR7ES 3330
8LDCR	PTR5A-10 5055
8LPR	BCPR7ES 3330
AW56C	BM7A 6521
AW5C	BM6A 5921
CM1N	AB2 3020
CM2N	AB2 3020
CM3N	A6 1010
CM3N	AB6 2910
CM4N	A6 1010
CM4N	AB6 2910
CM5N	A6 1010
CM5N	AB6 2910
CM6N	A7 1110
CM6N	AB7 3010
CU7N	C7HSA 4629
CW101L	B85EGV 7498
CW10L	B8EG 3430
CW112L	B9EG 3530
CW11L	B9EG 3530

MARELLI	NGK → STOCK No.
CW12L	B9EG 3530
CW12NV	BUH 2422
CW13L	B10EG 3630
CW14L	B10EG 3630
CW225A	B6HS 4510
CW250A	B7HS 5110
CW25N	B4H 4110
CW260N	B7HS 5110
CW2C	B2 3110
CW2CJ	B2 3110
CW2L	B4ES 4129
CW2N	B4H 4110
CW3C	B4 3210
CW3CJ	B4 3210
CW3CP	BP4 2911
CW3L	B4ES 4129
CW3N	B4H 4110
CW4A	B5ES 6410
CW4C	B4 3210
CW4CJ	B4 3210
CW4CP	BP4 2911
CW4L	B4ES 4129
CW4N	B4H 4110
CW4NJ	B4H 4110
CW55N	B5HS 4210
CW5C	B4 3210
CW5CP	BP5S 3011
CW5L	B5ES 6410
CW5LJ	B5ES 6410
CW5LP	BP5ES 6511
CW5LS	B5ES 6410
CW5LSZ	B5ES 6410
CW5N	B5HS 4210
CW5NJ	B5HS 4210
CW5NP	BP5HS 4111
CW5NR	BR5HS 3722
CW5NS	B5HS 4210
CW5NSZ	B5HS 4210
CW67L	B6ES 7310
CW67LP	BP6ES 7811
CW67N	BP6HS 4511
CW67NJ	B6HS 4510
CW67NR	BR6HS 3922
CW67P	BP5ES 6511
CW6C	B6S 3510
CW6CE	BM6A 5921
CW6CJ	B6S 3510
CW6L	B5ES 6410
CW6LJ	B5ES 6410
CW6LP	BP5ES 6511
CW6LR	BR5ES 4722
CW6LS	B5ES 6410
CW6LSZ	B5ES 6410
CW6N	B6HS 4510
CW6NE	BM6A 5921
CW6NJ	B6HS 4510
CW6NP	BP6HS 4511
CW6NPR	BPR6HS 7022
CW6NR	BR6HS 3922
CW75LP	BP6ES 7811
CW78L	B6ES 7310
CW78LP	BP6ES 7811
CW78LPR	BPR6ES 7822
CW78LPS	BP6ES 7811
CW7C	B6S 3510
CW7L	B6ES 7310
CW7LCR	BKR6E 6962
CW7LJ	B6ES 7310
CW7LP	BP6ES 7811
CW7LPH	BP6ES 7811
CW7LPR	BPR6ES 7822
CW7LR	BR6ES 4922
CW7N	B6HS 4510
CW7NJ	B6HS 4510

MARELLI	NGK → STOCK No.
CW7NP	BP6HS 4511
CW7NPR	BPR6HS 7022
CW7NR	BR6HS 3922
CW89LP	BP7ES 2412
CW8CJ	B7S 3710
CW8L	B7ES 1111
CW8LCR	BCPR7ES 3330
CW8LJ	B7ES 1111
CW8LP	BP7ES 2412
CW8LPR	BPR7ES 2023
CW8LPS	BP7ES 2412
CW8N	B7HS 5110
CW8NP	BP7HS 5111
CW8NR	BR7HS 4122
CW9L	B8ES 2411
CW9LJ	B8ES 2411
CW9LP	BP8ES 2912
CW9N	B8HS 5510
CWC12NJ	B8HS 5510
CWC67NJ	B6HS 4510
CWC6NJ	B6HS 4510
CWC7NJ	B6HS 4510
CWC9NJ	B7HS 5110
CWF11L	B8EVX 7051
CWP10L	B9EVX 7254
CWP10N	B9HVX 2294
CWP11L	B10EGV 5927
CWP8L	B7EVX 6934
CWP8N	B7HVX 7836
CWP9L	B8EVX 7051
CWP9N	B8HVX 2634
CX6N	D6HA 6512
CX8L	D8EA 2120
CX8N	D8HA 7112
DW4CJR	BR6S 3522
F6NC	BP5HS 4111
F6NCR	BPR5HS 6222
F7LC	BP6ES 7811
F7LCR	BPR6ES 7822
F7NC	BP6HS 4511
F7NCR	BPR6HS 7022
F8LC	BP7ES 2412
F8LCR	BPR7ES 2023
FC6N	B5HS 4210
FC7N	B6HS 4510
FC9L	BP8ES 2912
SW5C	BM6F 6221
T7LC	BP6EFS 3812
T7LCR	BPR6EFS 3623
T8LC	BP7ES 3526
TM4NP	AP6FS 2710
TW4LP	BP5EFS 3712
TW5NP	BP5FS 3412
TW6NP	BP6FS 3512
TW78LP	BP6EFS 3812
TW78LPR	BPR6EFS 3623
TW78NPR	BPR6FS 2623
TW7LP	BP6EFS 3812
TW7LPR	BPR6EFS 3623
TW7NP	BP6FS 3512

MAZDA	NGK → STOCK No.
0190 18 110	B6HS 4510
0259 18 110	BP6ES 7811
0370 18 110	BP6EVX 5832
0371 18 110	BP5EVX 5470
0376 18 110	BP7EVX 7270
0419 18 110	B7ES 1111
0420 18 110	B8ES 2411
0512 18 110	B6ES 7310
0660 18 110	BP5ES 6511
0745 18 110	BP7ES 2412
1002 77 550	BP5EY 7327
1003 77 550	BP6EY 7727

MAZDA	NGK → STOCK No.
1482 18 600A	BR8EQ 3328
1690 18 110	BPR6ES 7822
3648 18 600	BR7ET 4121
3649 18 600	BR8ET 4221
4885 18 110	BPR2ES 2264
4894 18 110	BP2ES 3467
8182 18 600	BR7EQ 5128
8344 18 600	BR9ET 4528
8914 18 110	BPR5ES 7422
A501 18 110	BP6E 7529
AZ08 18 110	BPR5E 7075
B601 18 110	BPR5ES-11 4424
B695 18 110	BCPR6E 1269
B6B3 18 110	BCPR5E-11 1273
BP01 18 110	BKR5E-11 6953
BP03 18 110	BKR6E-11 2756
BP05 18 110	BKR7E-11 1283
BP47 18 110	BKR5E 7938
BP49 18 110	BKR6E 6962
BP51 18 110	BKR7E 6097
F201 18 110	ZFR6A-11 1041
F203 18 110	ZFR5A-11 5084
F210 18 110	BCPR5E 1145
F220 18 110	BCPR6E-11 3132
F285 18 110	ZFR6F-11 4291
F287 18 110	ZFR5F-11 2262
F289 18 110	ZFR7F-11 2975
FE79 18 110	BPR6ES-11 4824
JE03 18 110	BCPR7E 1272
KJ11 18 110	PZFR6F 7550
L813 18 110	ITR6F13 4477
N322 18 110	BR10ET 7480
N342 18 110	BUR9EQ 5483
N3A1 18 110	BUR9EQP 5255
N3A3 18 110	BUR8EQP 4582
ZM0118110	IZFR5G 5887
MCC	NGK → STOCK No.
000 3085 V005 0000 00	BKR6EKE 5649
A 003 159 92 03	BKR6EKE 5649
MEGA FIRE	NGK → STOCK No.
SE8JC	BM6A 5921
MERCEDES	NGK → STOCK No.
002 159 18 03	BP7ES 2412
002 159 22 03	BP5ES 6511
002 159 24 03	BP6ES 7811
002 159 27 03	BP7ES 2412
002 159 28 03	BP6ES 7811
002 159 29 03	BP5ES 6511
002 159 31 03	BP5ES 6511
002 159 41 03	BP6ES 7811
002 159 42 03	BP6ES 7811
002 159 48 03	BP5ES 6511
002 159 49 03	BP6EFS 3812
002 159 56 03	BP6EFS 3812
002 159 57 03	BP5EFS 3712
002 159 58 03	BP5EFS 3712
002 159 64 03	BP7EFS 3526
002 159 65 03	BP7EFS 3526
002 159 68 03	BP6EFS 3812
002 159 69 03	BP6EFS 3812
002 159 76 03	BP5EFS 3712
002 159 77 03	BCP5ES 7496
003 159 04 03	BP5EFS 3712
003 159 05 03	BP5EFS 3712
003 159 06 03	BP6EFS 3812
003 159 07 03	BP6EFS 3812
003 159 08 03	BP7EFS 3526
003 159 12 03	BP6ESZ 7639
003 159 13 03	BP6ESZ 7639
003 159 14 03	BP7ES 2412
003 159 16 03	BCP6ES 4930

MERCEDES	NGK → STOCK No.
003 159 30 03	BCP5ES 7496
003 159 31 03	BCP6ES 4930
003 159 33 03	BP7EFS 3526
003 159 34 03	BP6EFS 3812
003 159 35 03	BP6EFS 3812
003 159 36 03	BP5EFS 3712
003 159 37 03	BCP5ES 7496
003 159 40 03	BP5EFS 3712
003 159 41 03	BP5EFS 3712
003 159 42 03	BCP5ES 7496
003 159 45 03	BP6ESZ 7639
003 159 56 03	BP7ES 2412
003 159 57 03	BP6ESZ 7639
003 159 75 03	BKUR5ET 2789
003 159 78 03	BKUR6ET-10 2397
003 159 91 03	BKR5EKUP 2890
003 159 97 03	IFR6D10 5344
004 159 13 03	ILFR6A 3588
004 159 14 03	IFR6Q-G 5648
004 159 20 03	IFR6D10 5344
004 159 30 03 26	BKR6EZB 4293
004 159 36 03	BKR6EZB 4293
004 159 49 03	PLKR7A 4288
MERCUISER NGK → STOCK No.	
33-104	BR7ES 5122
33-11458M	B6HS-10 1052
33-12127	BP6HS-10 6326
33-123	BR6ES 4922
33-12343	BP8HS-10 3823
33-12343B	BP8HS-10 3823
33-136862	BU8H 6431
33-136862B	BU8H 6431
33-14	BP5S 3011
33-14103550	BUZHW 2147
33-14103568	BUZ8H 7447
33-14103570	BUZHW-2 2173
33-14814548	BPZ8HS-10 3133
33-14814568	BPZ8HS-15 3180
33-17719547	BPR7HS-10 1092
33-18	BPR4FS-11 2527
33-18S	BPR4FS-11 2527
33-19424	BP8HS-15 6729
33-19796	BPR6HS-10 2623
33-306	B6HS 4510
33-312	BP6HS-10 6326
33-327	BPR6HS 7022
33-328	BP7HS 5111
33-33828C	BZ7HS-10 3579
33-400	BR6FS 4323
33-400S	BR6FS 4323
33-401	BP6EFS 3812
33-406	BPR6FS 2623
33-41263B	B7HS-10 2129
33-41263M	B7HS-10 2129
33-592	BR6S 3522
33-59571	BR6FS 4323
33-59571B	BR6FS 4323
33-63	BP5S 3011
33-670	R5673-8 4140
33-803507	DCPR6E 3481
33-807C	B8HS 5510
33-807S	B8HS 5510
33-809679	BR9ES 5722
33-809679B	BR9ES 5722
33-809680	BR8ES 5422
33-809680B	BR8ES 5422
33-811	B7HS 5110
33-811S	B7HS 5110
33-813413	B7S 3710
33-813414	BP7HS 5111
33-813415	B8S 3810
33-813421	R5673-8 4140
33-813423	BPR6HS 7022

MERCUISER	NGK → STOCK No.
33-813469	B6S 3510
33-8134711	BR6ES 4922
33-814	BPR7HS-10 1092
33-816336	BPR6EFS 3623
33-8167372	BP8H-N-10 4838
33-8167372B	BP8H-N-10 4838
33-8168372	BPZ8H-N-10 4495
33-8168372B	BPZ8H-N-10 4495
33-818	BR9ES 5722
33-818S	BR9ES 5722
33-821916	BR7HS 4122
33-821C	B9HS-10 3626
33-821S	B9HS-10 3626
33-823	B6S 3510
33-82370M	B6HS 4510
33-82370M1	B6HS 4510
33-82371B	B7HS 5110
33-82371M	B7HS 5110
33-82372M	B8HS 5510
33-823S	B6S 3510
33-824	BUHX 2522
33-825C	B7S 3710
33-825S	B7S 3710
33-827858	DPR6EA-9 5531
33-827859	CR6HS 7023
33-827C	BUHW 2622
33-828C	BZ7HS-10 3579
33-828S	BZ7HS-10 3579
33-833C	BUHW-2 5626
33-833S	BUHW-2 5626
33-838	BUZHW-2 2173
33-841C	B6S 3510
33-84409B	B8HS-10 5126
33-84409M	B8HS-10 5126
33-84675M	B5HS 4210
33-8556721	PZFR5F-11 4363
33-8557171	ZFR5F-11 2262
33-859495	LF5A-11 6376
33-874	BR7HS 4122
33-876	BUZ8H 7447
33-880	BR8ES 5422
33-881284	LF6A-11 3672
33-883	BR7HS 4122
33-885C	BU8H 6431
33-885S	BU8H 6431
33-886	BUZ8H 7447
33-896	B5HS 4210
33-898	BUZHW 2147
33-918	ZFR6F-11 4291
33-924	BP8HS-15 6729
33-936C	BP8HS-10 3823
33-936S	BP8HS-10 3823
33-938	BPZ8HS-10 3133
33-938	BPZ8HS-10 3133
33-939	BPZ8HS-15 3180
33-941	BR8HS 4322
33-97180	BUHW 2622
33-97180B	BUHW 2622
33-97182	BUHW-2 5626
33-97182B	BUHW-2 5626
33-97184	BP7HS-10 7829
33-97186	B9HS-10 3626
33-97186B	B9HS-10 3626
33-97389	BPR6FS 2623
MITSUBISHI	NGK → STOCK No.
1822A005	ILZFR6C-K 6645
1822A022	ILFR7H 5245
MD 313 443	PFR6G-11 5555
MD 360 019	IZFR6B 4880
MN 119500	IGR6A11 5743
MN 158 586	LZFR6AI 3656
MS 851 022	BP5ES 6511
MS 851 023	BP6ES 7811

MITSUBISHI	NGK → STOCK No.
MS 851 024	BP7ES 2412
MS 851 102	BP5EY 7327
MS 851 104	BP6EY 7727
MS 851 111	B4 3210
MS 851 113	B6S 3510
MS 851 121	BP4 2911
MS 851 126	BPR6E 6464
MS 851 132	B5HS 4210
MS 851 133	B6HS 4510
MS 851 134	B7HS 5110
MS 851 162	B5ES 6410
MS 851 163	B6ES 7310
MS 851 164	B7ES 1111
MS 851 165	B8ES 2411
MS 851 174	BR7ES 5122
MS 851 182	BP5ES 6511
MS 851 183	BP6ES 7811
MS 851 184	BP7ES 2412
MS 851 192	BP6ES 7811
MS 851 232	BPR5ES 7422
MS 851 233	BPR6ES 7822
MS 851 234	BPR7ES 2023
MS 851 235	BPR5ES 7422
MS 851 236	BPR6ES 7822
MS 851 237	BPR5ES-11 4424
MS 851 238	BPR6ES-11 4824
MS 851 239	BPR7ES-11 7226
MS 851 243	BP5EA-L 6111
MS 851 263	G2Z 3320
MS 851 283	BP6E 7529
MS 851 286	BP5EY 7327
MS 851 287	BP6EY 7727
MS 851 301	PGR5A-11 3573
MS 851 317	DCPR7E 3932
MS 851 327	DCPR7EVX 1179
MS 851 332	PFR6B-11 4014
MS 851 335	PFR5J-11 4642
MS 851 336	PFR6J-11 2743
MS 851 352	BK6E 3536
MS 851 357	BKR5E-11 6953
MS 851 358	BKR6E-11 2756
MS 851 367	BKR5E 7938
MS 851 368	BKR6E 6962
MS 851 403	BPR6ES-11 4824
MS 851 408	BPR6ES-11 4824
MS 851 412	BPR5ES 7422
MS 851 413	BPR6ES 7822
MS 851 414	BPR7ES 2023
MS 851 417	BPR5ES-11 4424
MS 851 418	BPR6ES-11 4824
MS 851 419	BPR7ES-11 7226
MS 851 454	BR7ES 5122
MS 851 473	PFR6B-11 4014
MS 851 473	PFR6J-11 2743
MS 851 478	BPR6ES-11 4824
MS 851 502	PFR6J-11 2743
MS 851 722	BK6E 3536
MS 851 727	BKR5E-11 6953
MS 851 728	BKR6E-11 2756
MS 851 737	BKR5E 7938
MS 851 738	BKR6E 6962
MS 851 882	BPR7EKN 7738
Z 2152 944	BPR6ES-11 4824
Z 2152 945	BPR6ES 7822
Z 2152 946	BR7ES 5122
Z 2152 947	BPR7ES 2023
Z 2152 948	BPR7ES-11 7226
Z 2152 949	BCPR7ES-11 1095
Z 2152 950	BCPR6ES-11 7121
MONTESA	NGK → STOCK No.
98059-56916-00	CR6EH-9 2688

MOTORCRAFT NGK → STOCK No.			MOTORCRAFT NGK → STOCK No.			MOTORCRAFT NGK → STOCK No.			MOTORCRAFT NGK → STOCK No.		
A11	B2	3110	AG252	BP6ES	7811	AGR31	BR6ES	4922	ASF32C	BPR6FS	2623
A11NX	BM4A	5628	AG252C	BP6ES	7811	AGR32	BPR6ES	7822	ASF32M	BPR6FS	2623
A11U	B2	3110	AG3	B6ES	7310	AGR32C	BPR6ES	7822	ASF42	BPR5FS-11	2924
A11X	B2	3110	AG3C	B6ES	7310	AGR32CU	BPR6ES	7822	ASF42-6C	BPR5FS-15	3124
A1CU	B8S	3810	AG3X	B6ES	7310	AGR34CU	BPR6EY	6427	ASF42C	BPR5FS-11	2924
A21X	B8S	3810	AG32A	BP6ES	7811	AGR41	BR5ES	4722	ASF52	BPR4FS	1127
A22NX	BPM7A	7321	AG32C	BP6ES	7811	AGR42	BPR5ES	7422	ASF52-6	BPR4FS-15	2727
A2NX	BM7A	6521	AG32CU	BP6ES	7811	AGR42C	BPR5ES	7422	ASF52C	BPR5FS	2423
A3CU	B6S	3510	AG4	B5ES	6410	AGR42CU	BPR5ES	7422	AT1	B8S	3810
A3NX	BM6A	5921	AG403	B10EGP	5224	AGR44CU	BPR5EY	2828	AT10	B2	3110
A3X	B6S	3510	AG403C	B10EGP	5224	AGR44CU-11	BPR5EY-11	3028	AT2	B7S	3710
A42	BP5S	3011	AG42	BP5ES	6511	AGR51	BR5ES	4722	AT3	B6S	3510
A42CU	BP5S	3011	AG42CU	BP5ES	6511	AGR52	BPR5ES	7422	AT4	B6S	3510
A5	B6S	3510	AG44	ZGR5C	6334	AGR52	BPR5ES	7422	AT42	BP5S	3011
A5CU	B6S	3510	AG44CU	BP5EA-L	6111	AGR701X	BR9EIX	3981	AT6	B6S	3510
A5X	B6S	3510	AG5	B5ES	6410	AGR82	BPR4ES	7222	AT8	B4	3210
A52	BP5S	3011	AG501X	B10EGV	5927	AGR901X	BR8EIX	5044	ATL3	B6L	3212
A52CU	BP5S	3011	AG52	BP5ES	6511	AGRF22	BPR6EFS	3623	ATL4	B6L	3212
A7	B4	3210	AG52	BP5ES	6511	AGRF22C	BPR6EFS	3623	ATL8	B4L	3112
A7LM	B4LM	3410	AG54	ZGR5C	6334	AGRF22C1	BPR6EFS	3623	AV1X	B8HS	5510
A7N	BM6A	5921	AG5CU	B5ES	6410	AGRF22PP1	PTR5D-10	3784	AV22CU	BPR6HS	4511
A7NU	BM6A	5921	AG603	B9EGP	2176	AGRF32	BPR6EFS	3623	AV2CU	B7HS	5110
A7NX	BM6A	5921	AG603C	B9EGP	2176	AGRF32C1	BPR6EFS	3623	AV2X	B7HS	5110
A7U	B4	3210	AG7	B5ES	6410	AGRF42	BPR5EFS	2223	AV3CU	B6HS	4510
A7X	B4	3210	AG701	B9ES	2611	AGRF52	BPR5EFS	2223	AV4	B5HS	4210
A82	BP4	2911	AG701C	B9ES	2611	AGRP52	ZFR4F-11	4043	AV42	BP5HS	4111
A9	B4	3210	AG701CU	B9ES	2611	AGS22C	BPR6ES	7822	AV52	BP5HS	4111
A901	B8S	3810	AG701X	B9EGV	5827	AGS32C	BPR5ES	7422	AV6	B4H	4110
A9X	B4	3210	AG9	B4ES	4129	AGS32C-11	BPR5ES-11	4424	AV6CU	B4H	4110
AE1C	B7HS	5110	AG9U	B4ES	4129	AGSF22PPJ	PTR6F-13	7569	AV701CU10	B9HS-10	3626
AE1X	B7HS	5110	AG901	B9ES	2611	AGSF32C	BPR5EFS	2223	AV82	BP4HS	3611
AE2	B7HS	5110	AG901C	B9ES	2611	AGSF32FM	PTR5D-13	6644	AV901CU	B9HS	5810
AE2C	B7HS	5110	AG901CU	B9ES	2611	AGSP32	BCPR6ES-11	7121	AV901X-4	B9HS-10	3626
AE2X	B7HS	5110	AG901X	B8EGV	5627	AGSP32C	BCPR6ES-11	7121	AVKO	BUH	2422
AE22	BP6HS	4511	AG902	BP8ES	2912	AGSP33C	ZFR6F-11	4291	AVKOD	BUHW	2622
AE22C	BP6HS	4511	AG903	B8EG	3430	AGSP52	BKR5E	7938	AVZKO	BUHX	2522
AE3	B6HS	4510	AGF12	BP7EFS	3526	AL11	B4L	3112	AWRF32	BPR6EFS	3623
AE3X	B6HS	4510	AGF12C	BP7EFS	3526	AL5	B6L	3212	AWRF42	BPR5EFS	2223
AE32	BP6HS	4511	AGF22C	BP6EFS	3812	AL5X	B6L	3212	AWSF22C	BPR6EFS	3623
AE32C	BP6HS	4511	AGF32CU	BP6EFS	3812	AL7	B6L	3212	AWSF22FS	PTR6D-13	5598
AE3C	B6HS	4510	AGFS22C1	BPR5EFS	2223	AL7U	B6L	3212	AWSF32	BPR6EFS	3623
AE4	B5HS	4210	AGFS22F13J	TR6AP-13	5809	AL7X	B6L	3212	AWSF32C	BPR6EFS	3623
AE4X	B5HS	4210	AGFS22FE13J	PTR6F-13	7569	AL9	B4L	3112	AWSF32F	PTR5D-10	3784
AE42	BP5HS	4111	AGFS22IPJ	ITR6F13	4477	AL9X	B4L	3112	AWSF32PP	PTR5D-10	3784
AE6	B5HS	4210	AGKO	BUE	2322	AR21X	BR6S	3522	AWSF42	BPR5EFS	2223
AE62	BP5HS	4111	AGN42	BP5ES	6511	AR31	BR6S	3522	AWSF42C	BPR5EFS	2223
AE7	B4H	4110	AGP12C	BCP7ES	5030	AR41	BR6S	3522	AWSF52C	BPR5EFS	2223
AE901	B9HS	5810	AGP22C	BCP6ES	4930	AR42	BP5S	3011	AWSFA32C	BPR5EFS	2223
AE901X	B9HS-10	3626	AGP701C	R7435-10	4897	AR51	BR6S	3522	AYFS092FEC	PLTR6A-10G	3587
AER32	BPR6HS	7022	AGP12C	BCPR7ES	3330	AR52	BP5S	3011	AYFS22C	TR5A-10	0005
AER4	BR5HS	3722	AGPR12PP8	PFR7B	4853	AR7N	BMR6A	7421	AYFS22CB	TR5B-13	4559
AER4X	BR5HS	3722	AGPR22C	BKR6E	6962	AR82	BP4	2911	AYFS22FE1J	PLTR6A-10G	3587
AF12	BP7FS	3612	AGPR22C1	BCPR6ES-11	7121	ARF2	BR6FS	4323	AYFS22P1	PTR5A-10	5055
A-2	B7FS	3027	AGPR22CD	BKR6E	6962	ARF22	BPR6FS	2623	AYFS22PP1	PTR5A-10	5055
AF22	BP6FS	3512	AGPR22CD1	BCPR6ES-11	7121	ARF22C	BPR6FS	2623	AYFS32CJ	TR5B-13	4559
AF32	BP6FS	3512	AGPR22PP	PFR6B-11	4014	ARF22CU	BPR6FS	2623	AYRF22PP	PTR5A-10	5055
AF3NX	BM7F	6421	AGPR22PPJ	PFR6B-11	4014	ARF3	BR6FS	4323	AZ2	B7S	3710
AF42	BP5FS	3412	AGPR32C	BKR6E	6962	ARF32	BPR6FS	2623	AZ3	B6S	3510
AF5NX	BM6F	6221	AGPR32CD1	BCPR6ES-11	7121	ARF32-6	BPR6FS	2623	AZ9	B4	3210
AG1	B8ES	2411	AGPR32PD	BKR5EKUP	2890	ARF32C-6	BPR6FS	2623	AZ901	B8S	3810
AG1C	B8ES	2411	AGPR902P	R7436-9	4899	ARF32M	BPR6FS	2623	AZFS22PP	PTR5A-10	5055
AG1X	B8ES	2411	AGPS22C	BCPR6ES	6130	ARF4	BR5FS	4123	AZFS32FE	PTR5A-10	5055
AG12	BP7ES	2412	AGPS22P1	BKR6EVX	3539	ARF41CU15	BR5FS-15	2224	B2W	A8	1210
AG12C	BP7ES	2412	AGPS32C	BCPR6ES	6130	ARF42	BPR5FS	2423	B3W	A7	1110
AG12CU	BP7ES	2412	AGPS44F	PZFR5D-11	7968	ARF42-6	BPR5FS-15	3124	B3W	AB7	3010
AG2	B7ES	1111	AGPS44F11J	PZFR5D-11	7968	ARF42CU	BPR5FS	2423	B3X	A7	1110
AG2C	B7ES	1111	AGR1X	BR8ES	5422	ARF4-6	BR5FS-15	2224	B3X	AB7	3010
AG2CU	B7ES	1111	AGR12C	BPR7ES	2023	ARF52	BPR4FS	1127	B4X	A7	1110
AG2X	B7ES	1111	AGR16C	BR8ET	4221	ARF52-6	BPR4FS-15	2727	B6W	AB7	3010
AG203	B11EGP	2191	AGR2C	BR7ES	5122	ARF6	BR5FS	4123	B6W	A6	1010
AG22	BP6ES	7811	AGR21	BR6ES	4922	ARF62	BPR4FS	1127	B8X	A6	1010
AG22C	BP6ES	7811	AGR22	BPR6ES	7822	ARF62-6	BPR4FS-15	2727	B8X	AB6	2910
AG22CU	BP6ES	7811	AGR22C	BPR6ES	7822	ARF8	BR5FS	4123	B8X	AB6	2910
AG23	B7ECS	2528	AGR22CU	BPR6ES	7822	ARF8-6	BR5FS-15	2224	BF12	AP8FS	2227
			AGR3X	BR6ES	4922	ASF32	BPR6FS	2623			

MOTORCRAFT	NGK → STOCK No.	
BF22	AP6FS	2710
BF22C	AP6FS	2710
BF22CU	AP6FS	2710
BF22CX	AP6FS	2710
BF22X	AP6FS	2710
BF32	AP6FS	2710
BF32CU	AP6FS	2710
BF32CX	AP6FS	2710
BF32X	AP6FS	2710
BR8	A6	1010
BR8	AB6	2910
BRF22	APR6FS	2922
BRF22C	APR6FS	2922
BRF32	APR6FS	2922
BRF42	APR5FS	3122
BRF82	APR5FS	3122
BSF32C	APR6FS	2922
BSF42C	APR5FS	3122
BSF82	APR5FS	3122
BSF92	APR5FS	3122
BT10	A6	1010
BT10	AB6	2910
BT15	AB2	3020
BT2	A8	1210
BT3	A7	1110
BT3	AB7	3010
BT4	A7	1110
BT4	AB7	3010
BT6	A6	1010
BT6	AB6	2910
BT8	A6	1010
BT8	AB6	2910
BT9	A6	1010
BT9	AB6	2910
BTF3	A6FS	2210
BTF31	A6FS	2210
BTF6	A6FS	2210
BTRF42	APR5FS	3122
BZ8	A6	1010
BZ8	AB6	2910
HG2	D8EA	2120
HG22	D8EA	2120
HG2CU	D8EA	2120
HGR2C	DR8ES-L	2923
HV2	D8HA	7112
HV22	D6HA	6512
HV3	D6HA	6512
PV2	C7HSA	4629
PV3	C6HSA	3228
TT4	G2Z	3320
TT8	G2Z	3320
YN2F-12405A2A	TR5B-13	4559
MV AGUSTA	NGK → STOCK No.	
7699116	CR9EKB	2305
NHSP LD - see CHINESE BRANDS		
NIPPON DENSO - see DENSO		
NISSAN	NGK → STOCK No.	
-01P15	BCPR5ES-11	3524
-01P16	BCPR6ES-11	7121
-01P17	BCPR7ES-11	1095
-02P15	BCPR5E-11	1273
-02P16	BCPR6E-11	3132
-10F15	BGP5ES	7496
-10F16	BGP6ES	4930
-10F17	BCP7ES	5030
-12E15	BCPR5ES	6130
-12E16	BKR6E	6962
-12E17	BCPR7ES	3330
-1P115	PFR5G-11	2647
-1P116	PFR6G-11	5555

NISSAN	NGK → STOCK No.	
-1P117	PFR7G-11	2380
-20J05	BKR5E	7938
-20J06	BKR6E	6962
-20J07	BKR7E	6097
22401-CK87B	PLZKAR6A-11	5118
22401-FU412	FR2A-D	4768
-30R15	ZFR5E-11	4435
-50Y05	BKR5E-11	6953
-50Y06	BKR6E-11	2756
-53J05	BKR5EY	7390
-53J06	BKR6EY	3696
-58S16	PFR6A-11	4045
-85E15	BKR5E-11	6953
-85E16	BKR6E-11	2756
-85E17	BKR7E-11	1283
-99B07	BCPR7ES-11	1095
-99B09	BCPR6ES-11	7121
-99B12	BCPR5ES-11	3524
-F2000	BPR4ES	7222
-P8315	BPR5ES-11	4424
-P8316	BPR6ES-11	4824
-P8317	BPR7ES-11	7226
-S2000	BPR5ES	7422
-S2100	BPR6ES	7822
-V1414	BPR4ES	7222
-V1415	BPR5ES	7422
-V1416	BPR6ES	7822
-V1417	BPR7ES	2023
-W8915	BP5ES	6511
-W8916	BP6ES	7811
-W8917	BP7ES	2412
OMC	NGK → STOCK No.	
115206	BP6HS	4511
387694	B7HS	5110
437929	BPR7HS	6422
445098	D6HA	6512
502177	B6HS	4510
502194	B7HS-10	2129
502196	BR6S	3522
502894	BUZ8H	7447
503948	BPR6HS	7022
503949	BR6HS	3922
503950	BR6HS	3922
504082	BR6HS	3922
509921	BUHW	2622
509922	BUHW-2	5626
509924	BUZ8H	7447
509925	BZ7HS-10	3579
509926	BUHXW-1	5526
509928	B6S	3510
509929	B7HS	5110
584918	DCPR7E	3932
771770	BUZHW-2	2173
OPEL - see VAUXHALL		
OREGON - see BRISK		
PAL	NGK → STOCK No.	
14-5	B4H	4110
14-5Y	BP4HS	3611
14-7	B5HS	4210
14-7Y	BP5HS	4111
14-8	B6HS	4510
14-8R	BR6HS	3922
14-8Y	BP6HS	4511
14-9	B8HS	5510
14-9R	BR7HS	4122
14-9Y	BP7HS	5111
14K-5	B4	3210
14K-5Y	BP4	2911
14K-7Y	BP5S	3011
14K-8	B6S	3510

PAL	NGK → STOCK No.	
14L-5	B5ES	6410
14L-5R	BR5ES	4722
14L-5Y	BP5ES	6511
14L-7	B6ES	7310
14L-7R	BR6ES	4922
14L-7Y	BP6ES	7811
14L-8	B6ES	7310
14L-8Y	BP6ES	7811
14L-9	B7ES	1111
14L-9Y	BP7ES	2412
17-9	B7HS	5110
18-5	A6	1010
18-5	AB6	2910
18-5R	A6	1010
18-5R	AB6	2910
18-7	A7	1110
18-7	AB7	3010
18-8W	A8	1210
B14YC	DP8EA-9	9521
D14YC	BCP7ES	5030
D15YC	BCP6ES	4930
D17YC	BCP5ES	7496
DR14YC	BCPR7ES	3330
DR15YC	BKR6E	6962
DR17YC	BCPR5ES	6130
G14YC	BP7EFS	3526
G15YC	BP6EFS	3812
G17YC	BP5EFS	3712
K17C	B6S	3510
K17Y	BP5S	3011
K19	B4	3210
L08W	B11EGV	5831
L12W	B9EVX	7254
L12YC	BP9ES	7526
L14C	B8ES	2411
L14YC	BP7ES	2412
L15C	B7ES	1111
L15W	B8EVX	7051
L15YC	BP6ES	7811
L17C	B6ES	7310
L17YC	BP5ES	6511
L19C	B5ES	6410
L5Y	BP5ES	6511
L7Y	BP6ES	7811
L8	B6ES	7310
L8Y	BP6ES	7811
L9Y	BP7ES	2412
LR12YC	BPR8ES	3923
LR14YC	BPR7ES	2023
LR15YC	BPR6ES	7822
N12YC	BP8ES	2912
N14C	B9HS	5810
N14YC	BP7HS	5111
N15C	B7ES	1111
N15YC	BP6HS	4511
N17C	B6HS	4510
N17Y	BP4HS	3611
N17YC	BP5HS	4111
N19	B4H	4110
N19C	B5HS	4210
N7	B6HS	4510
N7Y	BP6HS	4511
N8	B7HS	5110
N8Y	BP7HS	5111
NR12YC	BPR8HS	3725
NR15YC	BPR6HS	7022
P15	BM7A	6521
P15Y	BPM7A	7321
P17	BM6A	5921
P17Y	BPM6A	7021
PR15Y	BPMR7A	4626
PR17Y	BPMR6A	6726
S14L-13	B8EG	3430
S14L-15	B9EG	3530

PAL	NGK → STOCK No.	
S14L-17	B10EG	3630
U17	BM6F	6221
PEUGEOT	NGK → STOCK No.	
5960.15	BKR6EZ	4619
5960.17	LF85B	7113
5960.83	LZKAR7A	6799
5962.05	BP6EFS	3812
5962.09	BP6EFS	3812
5962.13	BP6ES	7811
5962.14	BP6EFS	3812
5962.15	BP6EFS	3812
5962.16	BP6ES	7811
5962.21	BP6ET	1263
5962.22	BPR6EIX	6637
5962.6V	BKR6EZ	4619
5962.71	BKR6ES	3783
5962.72	BP6EFS	3812
5962.80	BP6HS	4511
5962.82	BP6ES	7811
5962.87	BP6EFS	3812
5962.88	BP8ES	2912
5962.90	BP6HS	4511
5962.94	BP7ES	2412
5962.98	BP7ES	2412
5962.A1	BP7ES	2412
5962.A2	BP6ES	7811
5962.A3	BP6HS	4511
5962.A0	BP7ES	2412
5962.C5	BKR6ES	3783
5962.C6	BKR6ES	3783
5962.C0	BP5EFS	3712
5962.E2	BCP6ES	4930
5962.F7	BCP6ES	4930
5962.F8	BCP6ES	4930
5962.G8	BP7ES	2412
5962.H2	BKR6ES	3783
5962.H8	BKR5E	7938
5962.H9	BCPR5ES	6130
5962.J9	BKR6ES	3783
5962.J0	BCP6ES	4930
5962.K1	BCPR7ES	3330
5962.K3	BCP7ET	2078
5962.K4	BKR6ES	3783
5962.K6	BKR6ES	3783
5962.K7	BCPR6ET	2197
5962.K0	BCPR7ES	3330
5962.R5	BCPR6ET	2197
5962.R9	BKR6ES	3783
5962.S2	BKR6E	6962
5962.S4	BKR5E	7938
5962.T8	BKR6ES	3783
5962.V6	BKR5E	7938
5962.V7	BKR6ES	3783
5962.V8	BCPR7ES	3330
5962.W4	BCPR6ET	2197
5962.W6	BCPR7ES	3330
5962.W7	BCPR7ES	3330
5962.W9	BKR5EK	7956
5962.X5	BCP6ES	4930
5962.Y2	BKR5EK	7956
5962.Y8	BKR6EK	2288
5962.Z0	BKR6EK	2288
PRESTOLITE	NGK → STOCK No.	
10E2	C7HSA	4629
10E3	C7HSA	4629
10E4	C6HSA	3228
12E2	D8HA	7112
12E22	D6HA	6512
12E3	D8HA	7112
12E42	D6HA	6512
12G2	D8EA	2120
12G3	D8EA	2120

PRESTOLITE	NGK → STOCK No.	
14-11	B2	3110
14-11N	BPM6A	7021
14-11X	B2	3110
14-2X	B6S	3510
14-3	B6S	3510
14-3N	BM7A	6521
14-3X	B6S	3510
14-4	B6S	3510
14-42	BP5S	3011
14-5	B6S	3510
14-52	BP5S	3011
14-5X	B6S	3510
14-7	B4	3210
14-7N	BM6A	5921
14-7X	B4	3210
14-82	BP4	2911
14-9	B4	3210
14-9X	B4	3210
14E01	BUH	2422
14E1	B8HS	5510
14E2	B7HS	5110
14E22	BP7HS	5111
14E3	B6HS	4510
14E32	BP6HS	4511
14E4	B5HS	4210
14E42	BP6HS	4511
14E52	BP5HS	4111
14E6	B5HS	4210
14E62	BP5HS	4111
14E82	BP4HS	3611
14ER4	BR6HS	3922
14ER6	BR6HS	3922
14F22	BP6FS	3512
14F32	BP6FS	3512
14F3N	BM7F	6421
14F42	BP5FS	3412
14F52	BPR4FS	1127
14F7N	BM6F	6221
14G01	BUE	2322
14G1	B8ES	2411
14G12	BP8ES	2912
14G2	B7ES	1111
14G22	BP6ES	7811
14G3	B6ES	7310
14G32	BP5ES	6511
14G4	B6ES	7310
14G42	BP5ES	6511
14G5	B5ES	6410
14G52	BP5ES	6511
14G7	B5ES	6410
14G902	BP8ES	2912
14GF22	BP6EFS	3812
14GR22	BPR6ES	7822
14GR32	BPR5ES	7422
14GR4	BR6ES	4922
14GR42	BPR5ES	7422
14GR52	BPR4ES	7222
14GR53	ZGR5C	6334
14GR7	BR5ES	4722
14GRF22	BPR6EFS	3623
14GRF32	BPR5EFS	2223
14GRF52	BPR5EFS	2223
14L4	B6L	3212
14L7	B6L	3212
14L9	B4L	3112
14R3	BR6S	3522
14R32	BP5S	3011
14R4	BR6S	3522
14R42	BP5S	3011
14R5	BR6S	3522
14R52	BP4	2911
14R53	BP4	2911
14R7N	BM6A	5921
14R8	B6S	3510

PRESTOLITE	NGK → STOCK No.	
14RF22	BPR6FS	2623
14RF32	BPR5FS	2423
14RF32-6	BPR5FS-15	3124
14RF32A	BPR5FS-15	3124
14RF42	BPR5FS	2423
14RF42-6	BPR5FS-15	3124
14RF42A	BPR5FS-15	3124
14RF52	BPR4FS	1127
14RF52-6	BPR4FS-15	2727
14RF52A	BPR4FS-15	2727
14RF62	BPR4FS	1127
14RF62-6	BPR4FS-15	2727
14RF62A	BPR4FS-15	2727
18-10	A6	1010
18-10	AB6	2910
18-3	A6	1010
18-3	AB6	2910
18-4	A6	1010
18-4	AB6	2910
18-8	A6	1010
18-8	AB6	2910
18-9	A6	1010
18-9	AB6	2910
18F22	AP6FS	2710
18F3	A6FS	2210
18F32	AP6FS	2710
18F6	A6FS	2210
18RF32	APR6FS	2922
18RF42	APR6FS	2922
18RF82	APR6FS	2922
78-10	G2Z	3320
78-8	G2Z	3320

PROTECNICA	NGK → STOCK No.	
4708	BR2LM	5798
4843	BPM7A	7321

RENAULT	NGK → STOCK No.	
77 00 101 401	BCPR5ES	6130
77 00 103 502	BPR5ES	7422
77 00 103 503	BPR5ES	7422
77 00 103 533	BKR5EK	7956
77 00 107 916	BKR5EK	7956
77 00 260 637	BCP7ET	2078
77 00 266 295	BPR6EFS	3623
77 00 267 140	BPR6EFS	3623
77 00 267 805	BP7EFVX	3344
77 00 273 462	BKR6E	6962
77 00 273 698	BKR6EVX	3539
77 00 500 155	BKR6EZ	4619
77 00 500 192	LFR4AP-11	5613
77 00 553 622	BP6ES	7811
77 00 565 155	B9EVX	7254
77 00 587 168	BP6HS	4511
77 00 714 540	BPR6EFS	3623
77 00 722 095	BP6EFS	3812
77 00 724 821	BP6ES	7811
77 00 725 302	BPR5ES	7422
77 00 726 503	BP7EFS	3526
77 00 727 383	BPR6ES	7822
77 00 731 583	BP7EFS	3526
77 00 732 626	BP8ES	2912
77 00 733 422	BP5HS	4111
77 00 736 149	BP7EFS	3526
77 00 736 150	BP7EFS	3526
77 00 737 457	BP7EFS	3526
77 00 737 458	BP6EFS	3812
77 00 737 459	BP7ES	2412
77 00 737 612	BCP5ES	7496
77 00 742 094	BPR7ES	2023
77 00 743 137	BCP5ES	7496
77 00 743 920	BP5ES	6511
77 00 749 163	BCP5ES	7496
77 00 824 821	BP6ES	7811

RENAULT	NGK → STOCK No.	
77 00 852 522	BP6EFS	3812
77 00 852 543	BP7EFVX	3344
77 00 855 463	BCP6ET	4563
77 00 855 918	BP5EFS	3712
77 00 856 342	BCP6ET	4563
77 00 859 910	BCP5ES	7496
77 00 859 967	BP5ES	6511
77 00 861 471	BP7ES	2412
77 00 861 472	BP6ESZ	7639
77 00 862 054	BP5ES	6511
77 00 868 864	BPR7ES	2023
77 00 871 617	BCPR6ET	2197
77 01 021 767	BP6EFS	3812
77 01 041 214	BP5ES	6511
77 01 041 215	BP6EFS	3812
77 01 042 816	BKR6E	6962
77 01 043 624	BCPR6ET	2197
77 01 045 018	BP7EFS	3526
77 01 366 057	BP6HS	4511
77 01 366 084	B8EVX	7051
77 01 366 085	BP7EVX	6934
77 01 366 086	BP6ES	7811
77 01 366 087	BP7ES	2412
77 01 366 137	BP6EFS	3812
77 01 366 267	BP6HS	4511
77 01 366 268	BP7ES	2412
77 01 366 269	BP6ES	7811
77 01 366 270	BP6EFS	3812
77 01 366 513	BP5HS	4111
77 01 366 514	BP6EFS	3812
77 01 366 515	BP6HS	4511
77 01 366 516	BP6ES	7811
77 01 366 533	B6HS	4510
77 01 366 539	BP5ES	6511
77 01 366 903	BP5ES	6511
77 01 414 022	BP5HS	4111
77 01 414 025	BP6ES	7811
77 01 414 026	BP7EFS	3526
77 01 414 027	BP7EFS	3526
77 01 414 031	BPR6ES	7822
82 00 030 765	LZKAR7A	6799
82 00 314 928	PFR7G-9	4371
82 00 322 273	LZKAR7A	6799
82 00 363 384	PFR6G-9	4377
83 04 504 277	ZFR5F	5165
89 33 003 862	BKR6ES	3783
96 26 575 480	BKR6EK	2288
96 32 182 880	BKR6EK	2288
96 32 182 880	PFR6E-10	3688

SEAT	NGK → STOCK No.	
101 000 000AB	BP6ESZ	7639
101 000 001AB	BP6ET	1263
101 000 001AC	BP6ET	1263
101 000 001AD	BP5ET-10	5156
101 000 001AE	BP5ET	2287
101 000 002AB	BP6ESZ	7639
101 000 003AA	BCP7ET	2078
101 000 004AA	BCP7ET	2078
101 000 005AA	BP6ET	1263
101 000 005AB	BP6ET	1263
101 000 005AD	BP5ET-10	5156
101 000 005AE	BP5ET	2287
101 000 006AC	BP6ESZ	7639
101 000 007AA	BP6ET	1263
101 000 007AB	BP6ET	1263
101 000 007AC	BP5ET-10	5156
101 000 007AD	BP6ET	1263
101 000 017AA	BCP7ET	2078
101 000 026AA	BPR5EKU	5685
101 000 026AB	BUR6ET	3172
101 000 027AA	BP6ET	1263
101 000 027AB	BP5ET	2287
101 000 027AC	BP5ET-10	5156

SEAT	NGK → STOCK No.	
101 000 028AA	BCP7ET	2078
101 000 029AA	BUR6EFSZ	6837
101 000 029AB	BUR6EFSZ	6837
101 000 033AA	BKUR6ET-10	2397
101 000 033AB	BKUR7ET	7873
101 000 033AC	BKUR5ET	2789
101 000 033AF	BKUR6ET	6437
101 000 034AA	BP6ESZ	7639
101 000 035 HJ	BKR6EKUB	3584
101 000 035AB	BKR5EKU	3964
101 000 035AE	BK7EKU	6236
101 000 035AF	BKR7EKU	5881
101 000 035AH	BKR5EKUP	2890
101 000 036AA	BUR6ET	3172
101 000 036AB	BUR5ET	3377
101 000 036AC	BUR5ET-10	7264
101 000 038AA	BPR5EKU	5685
101 000 038AB	BPR5EKU	5685
101 000 039AA	BPR5EKU	5685
101 000 039AB	BPR5EKU	5685
101 000 040AC	BUR5ET	3377
101 000 040AD	BUR6ET	3172
101 000 040AE	BUR5ET-10	7264
101 000 041AC	BKUR6ET-10	2397
101 000 041AD	BKUR6ET	6437
101 000 041AE	BKUR7ET	7873
101 000 050AA	BPR5EKU	5685
101 000 050AB	BUR5ET	3377
101 000 050AC	BUR6ET	3172
101 000 051AA	BKUR6ET-10	2397
101 000 051AB	BKUR7ET	7873
101 000 055 AA	BKR6EK	2288

SMART - see MCC

SPLITFIRE	NGK → STOCK No.	
TP006A	BP8EVX	2671
TP006B	BP7EVX	7270
TP006C	BP6EVX	5832
TP006D	BP5EVX	5470
TP006E	BP5EVX	5470
TP406B	B9EVX	7254
TP406B	BR9EIX	3981
TP406C	B8EVX	7051
TP406C	BR8EIX	5044
TP430B	CR9EIX	3521
TP430C	CR8EIX	4218

SUBARU	NGK → STOCK No.	
22401AA020	BP6ES	7811
22401AA090	BP7ES	2412
22401AA120	BPR6ES-11	4824
22401AA220	BPR6ES	7822
22401AA230	BPR7E	1142
22401AA310	BKR6E-11	2756
22401AA370	PFR6B-11	4014
22401AA400	PFR6B	3500
22401AA480	BPR5ES-11	4424
22401AA510	BKR6EVX	3539
22401KA080	BKR6E	6962
22401KA100	BCPR6E	1269
22401KA210	BKR5E-11	6953
320540800	B6ES	7310
320541110	B7ES	1111
320541120	B7EVX	6934
320545700	BR6ES	4922
382420800	B5ES	6410
420543200	BP5ES	6511
490010003	BP5EVX	5470
490010013	BP6EVX	5832
490010023	BP7EVX	7270
490010033	BPR5ES	7422
490010043	BP5EY	7327
490010053	BP6EY	7727

SUBARU	NGK → STOCK No.	
820541810	B6HS	4510
820546010	B8HS	5510
820548020	B8HVX	2634
820549310	B7HS	5110
820549320	B7HVX	7836
882417800	B5HS	4210
890573400	B6S	3510
SUZUKI	NGK → STOCK No.	
09482-00036	BP4HS	3611
09482-00066	B9ES	2611
09482-00082	B7HS	5110
09482-00084	BP6HS	4511
09482-00088	BR6HS	3922
09482-00089	B7ES	1111
09482-00091	B8ES	2411
09482-00095	B6HS	4510
09482-00098	BR9ES	5722
09482-00102	BR8HS	4322
09482-00105	BP7HS	5111
09482-00115	BR9EIX	3981
09482-00116	BR7HS	4122
09482-00117	BR7ES	5122
09482-00118	BP6ES	7811
09482-00121	BR8ES	5422
09482-00124	BP5HS	4111
09482-00127	BR9ES	5722
09482-00131	BP5ES	6511
09482-00136	BPR4HS	7823
09482-00139	BP7ES	2412
09482-00141	BPR6HS	7022
09482-00143	BR5HS	3722
09482-00144	D8EA	2120
09482-00147	BPR5HS	6222
09482-00149	DR8ES-L	2923
09482-00155	BPR5ES	7422
09482-00157	BR8HS	4322
09482-00175	BP8ES	2912
09482-00177	BP6ES	7811
09482-00181	BR10EV	5127
09482-00182	D7EA	7912
09482-00184	D9EA	2420
09482-00198	B8HS	5510
09482-00205	BPR4HS	7823
09482-00208	B8EGV	5627
09482-00209	B9EGV	5827
09482-00210	B10EGV	5927
09482-00220	DR7ES	3123
09482-00221	DR8ES	5423
09482-00229	BPR6ES	7822
09482-00230	BR8HS	4322
09482-00237	B8HS	5510
09482-00239	BPR8ES	3923
09482-00255	BPR7HS	6422
09482-00258	BPMR6A	6726
09482-00259	BP6HS	4511
09482-00261	BPMR4A	6028
09482-00264	BP6HS-10	6326
09482-00269	B7HS-10	2129
09482-00277	BR7HS-10	1098
09482-00278	B8HS-10	5126
09482-00279	B8HS-10	5126
09482-00280	BR8HS-10	1134
09482-00285	BPR6ES-11	4824
09482-00290	BP4HS	3611
09482-00299	BPR6ES	7822
09482-00316	BPR5HS	6222
09482-00321	C8HSA	6821
09482-00327	BR6HS-10	1090
09482-00330	DPR9EA-9	5329
09482-00332	DP8EA-9	9521
09482-00334	DPR8EA-9	4929
09482-00338	B6HS-10	1052
09482-00340	CR6HS	7023

SUZUKI	NGK → STOCK No.	
09482-00341	BR6HS-10	1090
09482-00348	BR8ES	5422
09482-00349	BR9ES	5722
09482-00351	B9ES	2611
09482-00354	DPR7EA-9	5129
09482-00358	BR4HS	3322
09482-00359	BPR5HS	6222
09482-00360	BR10ES	4832
09482-00367	BPR4HS	7823
09482-00370	BR8HS-10	1134
09482-00375	B8HS-10	5126
09482-00385	BP7ES	2412
09482-00389	JR9B	3188
09482-00391	JR10B	1299
09482-00397	JR9C	6193
09482-00398	DR7EA	7839
09482-00399	DR8EA	7162
09482-00400	DR9EA	3437
09482-00406	CR6HSA	2983
09482-00408	CR7HSA	4549
09482-00410	CR9EK	4548
09482-00412	CR8EK	3478
09482-00426	BK6E	3536
09482-00427	BKR6E	6962
09482-00433	BPR5EY-11	3028
09482-00446	DCPR6E	3481
09482-00448	DCPR7E	3932
09482-00450	DCPR8E	4179
09482-00456	CR8E	1275
09482-00458	CR9E	6263
09482-00460	CR10E	6264
09482-00462	CR10EK	2360
09482-00463	CR10EK	2360
09482-00464	BR8HCS-10	1157
09482-00467	BR9HS-10	4551
09482-00470	BR8ECM	3035
09482-00472	BR9ECM	3252
09482-00474	BR10ECM	4234
09482-00477	BKR5E	7938
09482-00479	DCPR7EVX	1179
09482-00485	CR8HSA	2086
09482-00486	BR8HCS-10	1157
09482-00487	BPR6ES	7822
09482-00491	JR9B	3188
09482-00494	BKR6E-11	2756
09482-00495	BPR7ES	2023
09482-00499	R4118S-8	3236
09482-00500	R4118S-9	3245
09482-00504	BPR5EY	2828
09482-00509	R6918B-8	4492
09482-00511	R6918B-7	6259
09482-00513	R0045J-10	7400
09482-00514	R0045J-11	9444
09482-00516	CR7E	4578
09482-00519	BR9EYA	7548
09482-00521	PGR5A	3987
09482-00522	BPR7HS-10	1092
09482-00523	BPR8HS	3725
09482-00528	CR6E	6965
09482-00530	BPR6HS	7022
09482-00531	BP6HS	4511
09482-00532	B7HS-10	2129
09482-00533	BR7HS-10	1098
09482-00534	B6HS-10	1052
09482-00535	BR6HS-10	1090
09482-00537	DCPR9EVX	6436
09482-00547	IFR5E11	7994
09482-00548	IFR6E11	6741
09482-00550	IFR6J11	7658
09482-00561	BR8EG	3130
09482-69001	BPR6HS	7022

SUZUKI AUTO	NGK → STOCK No.	
09482-00167-000	BPR5EA-L	5823
09482-00167-001	BPR5ES	7422
09482-00299-000	BPR6ES	7822
09482-00409-001	BPR6ES	7822
09482-00429-000	BKR6E	6962
09482-00429-001	BKR6E	6962

TORCH - see CHINESE BRANDS

TOYOTA	NGK → STOCK No.	
90919-01210	IFR6T11	4589
90919-01215	IFR5T-8N	3508
90919-01235	LFR6C-11	5788
90919-W1001	LFR6C-11	5788

UNIPART	NGK → STOCK No.	
GSP130	B5ES	6410
GSP131	BP5ES	6511
GSP141	BP5ES	6511
GSP151	BP6ES	7811
GSP160	B6ES	7310
GSP163	BP6ES	7811
GSP171	BP6ES	7811
GSP181	BP7ES	2412
GSP191	BP8ES	2912
GSP2001	BKR6E	6962
GSP2002	BPR6ES	7822
GSP2003	BKR6E	6962
GSP2004	ZFR6F-11	4291
GSP2005	BCPR6ES-11	7121
GSP2006	BPR6EFS	3623
GSP2007	BKR6E	6962
GSP2008	BPR5ES	7422
GSP2009	BPR6ES	7822
GSP2010	BP6ET	1263
GSP2013	ZGR5A	5839
GSP2015	BKR6E	6962
GSP2017	BKR5EK	7956
GSP2018	BKR5EK	7956
GSP2019	BPR6ES-11	4824
GSP2020	BPR5ES	7422
GSP2021	AP6FS	2710
GSP2022	BKR5E	7938
GSP2023	BCPR7ES	3330
GSP2024	BP6ET	1263
GSP2025	ZFR5F	5165
GSP2026	APR6FS	2922
GSP2027	BPR6EFS	3623
GSP2028	BKR6EKC	2848
GSP2029	BPR6HS	7022
GSP2030	BUR6ET	3172
GSP2031	BP5ET	2287
GSP2032	B5HS	4210
GSP2033	APR5FS	3122
GSP2034	BPR6ES	7822
GSP2035	BCP5ES	7496
GSP2036	BPR7ES	2023
GSP2037	BCPR6ES-11	7121
GSP2038	BUR5ET	3377
GSP2039	BPR5ES-11	4424
GSP2040	BP5EFS	3712
GSP2041	BKR6EQUP	3199
GSP2044	PFR7B	4853
GSP2045	BKR5E-11	6953
GSP2046	B6ES	7310
GSP2048	BKUR7ET	7873
GSP2049	B6HS	4510
GSP2050	B7HS	5110
GSP2051	BR8ES	5422
GSP2053	BKR6EK	2288
GSP2055	PFR6B-11	4014
GSP2056	BP6HS	4511
GSP2059	BKR6EQUP	3199
GSP2064	BCPR6ET	2197

UNIPART	NGK → STOCK No.	
GSP2065	BP5HS	4111
GSP2066	BKR6EKC	2848
GSP2070	BKR6EKC	2848
GSP2071	ZFR4F-11	4043
GSP2072	ZFR6F-11	4291
GSP2073	BKUR5ET	2789
GSP2074	BP6EVX	5832
GSP2075	BP7HS	5111
GSP2081	BPR6ES-11	4824
GSP2082	BP7EVX	7270
GSP2085	BCPR7ES-11	1095
GSP2086	B8EFS	1049
GSP2087	BKUR6ET-10	2397
GSP2088	BCPR6ET	2197
GSP2090	BR7ES	5122
GSP2094	BP5EFS	3712
GSP2098	BP6ES	7811
GSP2099	BP5ES	6511
GSP2100	BCP6ES	4930
GSP2101	BP6EFS	3812
GSP2102	BP6EFS	3812
GSP2103	BCP6ES	4930
GSP2106	TR5A-10	0005
GSP2108	DCPR8E-N	5692
GSP2110	BKR6E	6962
GSP2111	BPR6ES	7822
GSP2112	BKR6E	6962
GSP2113	ZFR6F-11	4291
GSP2114	BCPR6ES-11	7121
GSP2115	BPR6EFS	3623
GSP2116	BKR6E	6962
GSP2117	BPR5ES	7422
GSP2118	BPR6ES	7822
GSP2119	BPR6ES-11	4824
GSP2120	BPR6EFS	3623
GSP2121	BP5EFS	3712
GSP2122	PFR6N-11	3546
GSP2136	BKR6EQUP	3199
GSP2137	LFR6B	6677
GSP2138	LFR5B	7113
GSP2149	ZFR6S-Q	6449
GSP2151	IZKR7B	7563
GSP2212	PFR6N-11	3546
GSP244	BPR5ES	7422
GSP263	BPR6ES	7822
GSP264	BPR5ES	7422
GSP281	BPR7ES	2023
GSP30	B6S	3510
GSP331	BP5EFS	3712
GSP351	BP5EFS	3712
GSP361	BP6EFS	3812
GSP381	BP7EFS	3526
GSP4154	AP6FS	2710
GSP4266	B5HS	4210
GSP4352	BP6ES	7811
GSP4356	BP6HS	4511
GSP4362	BP6ES	7811
GSP4366	BP6HS	4511
GSP4372	BP5ES	6511
GSP4376	BP5HS	4111
GSP4382	BP5ES	6511
GSP4452	BPR7ES	2023
GSP4462	BPR6ES	7822
GSP4472	BPR5ES	7422
GSP4552	BCP7ES	5030
GSP4562	BCP6ES	4930
GSP4563	BP6EFS	3812
GSP4573	BP5EFS	3712
GSP461	BPR6EFS	3623
GSP4652	BCPR7ES	3330
GSP4662	BKR6E	6962
GSP4663	BPR6EFS	3623
GSP531	BP5HS	4111
GSP540	B5HS	4210

UNIPART	NGK → STOCK No.	
GSP541	BP6HS	4511
GSP550	B6HS	4510
GSP560	B7HS	5110
GSP571	BP7HS	5111
GSP634	BCPR5ES	6130
GSP6356	BP6HS	4511
GSP6382	BP5ES	6511
GSP6452	BPR7ES	2023
GSP6462	BPR6ES	7822
GSP6468	BPR6ES-11	4824
GSP6472	BPR5ES	7422
GSP664	BKR6E	6962
GSP665	BCP6ES	4930
GSP6651	PTR5A-10	5055
GSP6652	BCPR7ES	3330
GSP6658	BCPR7ES-11	1095
GSP6662	BKR6E	6962
GSP6663	BPR6EFS	3623
GSP6668	BCPR6ES-11	7121
GSP684	BCPR7ES	3330
GSP685	BCP7ES	5030
GSP761	BP6FS	3512
GSP881	BPR6FS	2623
GSP9652	PFR6N-11	3546
GSP981	AP6FS	2710
VAUXHALL/OPEL	NGK → STOCK No.	
90 239 568	BPR6ES	7822
90 239 569	BPR6HS	7022
90 336 461	BKR6ES	3783
90 338 179	BCPR6ET	2197
90 355 136	BPR6ES	7822
90 356 323	BPR5ES	7422
90 357 729	BKR6EK	2288
90 357 780	BKR6ES	3783
90 423 215	BKR6ES	3783
90 512 989	BKR5EK	7956
91 132 086	BKR5EQUB	1567
91 951 09	BKR5EK	7956
91 958 68	BKR5EQUB	1567
91 990 38	LTR6B-10T	5948
93 161 199	PFR6G-9	4377
93 176 801	ZFR5F	5165
VOLVO	NGK → STOCK No.	
13 06 604	BPR6ES	7822
13 06 605	BPR6ES	7822
13 57 828	BPR7HS	6422
13 67 528	BPR6ES	7822
13 67 529	BPR6ES	7822
271 603	BKR6E	6962
271 727	BKR6E	6962
30637385	LF6D	4704
30650379	PLFR5A-11	7654
30731425	TR5B-13	4559
30777349	TR6AP-13	5809
35 17 980	BKR6E	6962
8658474	PLFR6A-11	7654
8694749	ITR6F13	4477
9146775	BKR6ETUC	3384
9202064	BKR6ETUC	3384
VW/AUDI	NGK → STOCK No.	
101 000 000AB	BP6ESZ	7639
101 000 001AB	BP6ET	1263
101 000 001AC	BP6ET	1263
101 000 001AD	BP5ET-10	5156
101 000 001AE	BP5ET	2287
101 000 002AB	BP6ESZ	7639
101 000 003AA	BCP7ET	2078
101 000 004AA	BCP7ET	2078
101 000 005AA	BP6ET	1263
101 000 005AB	BP6ET	1263
101 000 005AD	BP5ET-10	5156

VW/AUDI	NGK → STOCK No.	
101 000 005AE	BP5ET	2287
101 000 005AF	BP5ET	2287
101 000 006AB	BP6ESZ	7639
101 000 006AC	BP6ESZ	7639
101 000 007AA	BP6ET	1263
101 000 007AB	BP6ET	1263
101 000 007AC	BP5ET-10	5156
101 000 007AD	BP6ET	1263
101 000 016AA	PFR7B	4853
101 000 016AB	PFR6Q	6458
101 000 017AA	BCP7ET	2078
101 000 026AB	BUR6ET	3172
101 000 027AA	BP6ET	1263
101 000 027AB	BP5ET	2287
101 000 027AC	BP5ET-10	5156
101 000 028AA	BCP7ET	2078
101 000 029AB	BUR6EFSZ	6837
101 000 033AA	BKUR6ET-10	2397
101 000 033AB	BKUR7ET	7873
101 000 033AC	BKUR5ET	2789
101 000 033AF	BKUR6ET	6437
101 000 033AG	BKUR5ET-10	7553
101 000 034AA	BP6ESZ	7639
101 000 035AB	BKR5EKU	3964
101 000 035AH	BKR5EKUP	2890
101 000 035HJ	BKR6EKUB	3584
101 000 036AA	BUR6ET	3172
101 000 036AB	BUR5ET	3377
101 000 036AC	BUR5ET-10	7264
101 000 038AA	BPR5EKU	5685
101 000 038AB	BPR5EKU	5685
101 000 039AA	BPR5EKU	5685
101 000 039AB	BPR5EKU	5685
101 000 040AC	BUR5ET	3377
101 000 040AD	BUR6ET	3172
101 000 040AE	BUR5ET-10	7264
101 000 041AC	BKUR6ET-10	2397
101 000 041AD	BKUR6ET	6437
101 000 041AE	BKUR7ET	7873
101 000 047AC	BKR6EVX	3539
101 000 049AD	BKR6ETA-10	7998
101 000 050AA	BUR5ET	3377
101 000 050AB	BUR5ET-10	7264
101 000 050AC	BUR6ET	3172
101 000 051AA	BKUR6ET-10	2397
101 000 051AB	BKUR7ET	7873
101 000 052AA	BUR6EFSZ	6837
101 000 055AA	BKR6EK	2288
101 000 060AA	BKUR5ET-10	7553
101 000 062AB	PZFR5D-11	7968
101 000 063AA	PFR6Q	6458
101 000 063AC	PFR7Q	7963
101 000 065AA	BKR6ETA-10	7998
101 905 600 A	PZFR6J-11	3586
101 905 601	PZFR5D-11	7968
101 905 601B	ZFR5P-G	6893
101 905 601F	ZFR6T-11G	5960
101 905 606A	IZKR7B	7563
101 905 607	BKR6EKUE	9892
101 905 616	BKR6EQUA	6872
101 905 617	ZFR5P-G	6893
101 905 617C	ZFR6T-11G	5960
101 905 620	PZFR5N-11T	7742
101 905 631C	PFR6Q	6458
WOLF	NGK → STOCK No.	
1015 306	A6	1010
1015 306	AB6	2910
1018 301	BM6A	5921
1022 304	A6	1010
1022 304	AB6	2910
2000 305	BMR6A	7421
2016 301	B7HS	5110
2050 324	BMR6A	7421

WOLF	NGK → STOCK No.	
2085 300	BR6ES	4922
2090 306	BPR6ES	7822
YAMAHA	NGK → STOCK No.	
90793 20029	B95EGV	2145
90793 20030	B105EGV	2171
90793 20032	B10EG	3630
90890 78082	B10EGV	5927
94701 00039	B6HS	4510
94701 00040	B7HS	5110
94701 00041	B8HS	5510
94701 00042	B9HS	5810
94701 00043	B6ES	7310
94701 00044	B7ES	1111
94701 00045	B8ES	2411
94701 00046	B9ES	2611
94701 00050	BP7HS	5111
94701 00061	B8EVX	7051
94701 00063	B9EVX	7254
94701 00069	B5HS	4210
94701 00078	B5ES	6410
94701 00108	BP6HS	4511
94701 00110	BR7HS	4122
94701 00111	BR6ES	4922
94701 00112	BR7ES	5122
94701 00113	BR8EIX	5044
94701 00116	BP6ES	7811
94701 00117	BP7ES	2412
94701 00118	BP8ES	2912
94701 00148	B8HVX	2634
94701 00157	D8EA	2120
94701 00159	BP4HS	3611
94701 00160	B8HS-10	5126
94701 00168	BP5HS	4111
94701 00188	BR9ES	5722
94701 00189	D7EA	7912
94701 00193	BR9EIX	3981
94701 00194	BPR5HS	6222
94701 00195	BR8HS	4322
94701 00198	BPR6HS	7022
94701 00203	DR8ES-L	2923
94701 00204	BR8ES	5422
94701 00208	DR7ES	3123
94701 00217	B7HS-10	2129
94701 00218	BPR7ES	2023
94701 00219	BPR8ES	3923
94701 00227	BPR7HS	6422
94701 00232	BP6HS-10	6326
94701 00234	BPR6ES	7822
94701 00237	BP8HS-10	3823
94701 00241	DPR8EA-9	4929
94701 00248	BR6HS	3922
94701 00250	CR7HS	7223
94701 00251	BR9HS	4522
94701 00254	C7HSA	4629
94701 00256	C6HSA	3228
94701 00258	BPR4HS	7823
94701 00262	DPR7EA-9	5129
94701 00264	BP7HS-10	7829
94701 00266	D9EA	2420
94701 00268	BP8HS	2630
94701 00273	B6HS-10	1052
94701 00274	BR6HS-10	1090
94701 00280	BPR8HS	3725
94701 00282	CR6HS	7023
94701 00284	BP6EVX	5832
94701 00285	BPR6EIX	6637
94701 00287	DR8ES	5423
94701 00292	BPR6HS-10	2633
94701 00300	CR5HS	2874
94701 00309	BR9HS-10	4551
94701 00311	BR5ES	4722
94701 00318	CR9E	6263
94701 00328	BPR5ES	7422

YAMAHA	NGK → STOCK No.	
94701 00330	CR8E	1275
94701 00332	R5184-105	3334
94701 00333	DR8EA	7162
94701 00340	DR9EA	3437
94701 00345	DR7EA	7839
94701 00353	CR7E	4578
94701 00361	DPR9EA-9	5329
94701 00365	BR6FS	4323
94701 00372	CR6HSA	2983
94701 00375	DPR6EA-9	5531
94701 00395	CR9EK	4548
94701 00403	CR9EK	4548
94701 00406	DPR5EA-9	2887
94701 00408	CR9EA-9	6289
94702 00044	B7ES	1111
94702 00045	B8ES	2411
94702 00046	B9ES	2611
94702 00149	B7HS	5110
94702 00188	BR9ES	5722
94702 00193	BR9EIX	3981
94702 00195	BR8HS	4322
94702 00204	BR8ES	5422
94702 00211	BPMR6A	6726
94702 00247	BR8HS-10	1134
94702 00248	BR6HS	3922
94702 00249	BR5HS	3722
94702 00271	BR7HS-10	1098
94702 00272	BR7HS	4122
94702 00274	BR6HS-10	1090
94702 00309	BR9HS-10	4551
94702 00317	B9HS-10	3626
94702 00323	B8EG	3430
94702 00324	BR9EG	3230
94702 00325	B9EG	3530
94702 00326	BR8EG	3130
94702 00331	BPR4ES	7222
94702 00343	BR4ES	1097
94702 00348	BPR2ES	2264
94702 00349	BR7ES	5122
94702 00357	BR9ECM	3252
94702 00367	B10EG	3630
94702 00391	LF5A-11	6376
94702 00400	LF6A-11	3672
94702 00404	BKR7EKU	5881
94702 00405	BKR6EKU	6993
94702 00409	CR9EB	6955
94702 00419	CR4HSB	4695
94703 00277	B9EGV	5827
YANMAR	NGK → STOCK No.	
124190-78010	BPR4ES	7222
160110-78011	B6HS	4510
160232-78010	B4H	4110
160560-78010	BPMR4A	6028
160610-78010	BP4HS	3611
160690-78010	BP6ES	7811
160693-78010	BPR6ES	7822
160769-78010	BR4HS	3322
160793-78010	BPR5ES	7422
160810-78010	BPR4HS	7823
160998-78010	BPR6EY	6427
181630-78010	BUHW	2622



SPARK PLUG COVERS

STANDARD PLUG COVERS



EPDM RUBBER PLUG COVERS

LB05F
LD05F

LB05EMH

SDO5FM



The NGK range of resistor covers are designed to give perfect noise suppression across all frequencies whilst engine performance is not adversely affected whatsoever.

Featuring a resistor element pressed in between the plug terminal and the high tension wire connection, the construction is extremely durable, the resistor element is long enough to prevent interior flashover, and steady resistance is maintained. Superlative ceramic materials are incorporated that resist deterioration and have small resistance variation under over-load, whilst the plug connector is made of sturdy phenolic resin, practically oblivious to tremendous heat and high tension, and very rugged rubber material. The heat press insertion makes the construction all the more tough and vibration-resistant. Special rubber liners on both ends prevent moisture from causing electrical leakage.

All motorcycle manufacturers now comply with current legislation which demands a standard of noise suppression on every vehicle. This is achieved usually by fitting NGK resistor covers though in many cases a combination of NGK resistor covers and NGK resistor spark plugs (R type) is necessary to satisfy the ministry tests. It is emphasized that despite the use of both resistor covers and spark plugs in such engines, due to the unique and superior construction of NGK products there is no loss of performance or shortening of service life.

LB05EMH and SDO5FM being of tough EPDM rubber construction are intended for competition/trial applications.

COVER SYMBOLS EXPLANATION CHART

	External appearance	Resistance	Suitable Terminal Type	Suitable \varnothing Plug Thread	Special Feature
L	L 90° Elbow Type	None Non-resistor	E Terminal nut or solid post	B 14 mm minimum	A Special design
	S Straight	01 1 k Ω	F Terminal stud	C 10 mm minimum	H Compact type
	X 102° Elbow Std.	05 5 k Ω		D 10 & 12 mm	P Special waterproof cover
	V 120° Elbow (Long)	10 10 k Ω		Z 10, 12 & 14 mm	K Silicon waterproof cover
	Y 120° Elbow (Short)				M Rubber sheathed
	T 'T' Type				G With rubber grommet
					W Double connector springs
					F For \varnothing 5mm HT cable
					L Inductive resistor type
					Y With handle
					Z Special design

NGK RESISTOR PLUG COVERS

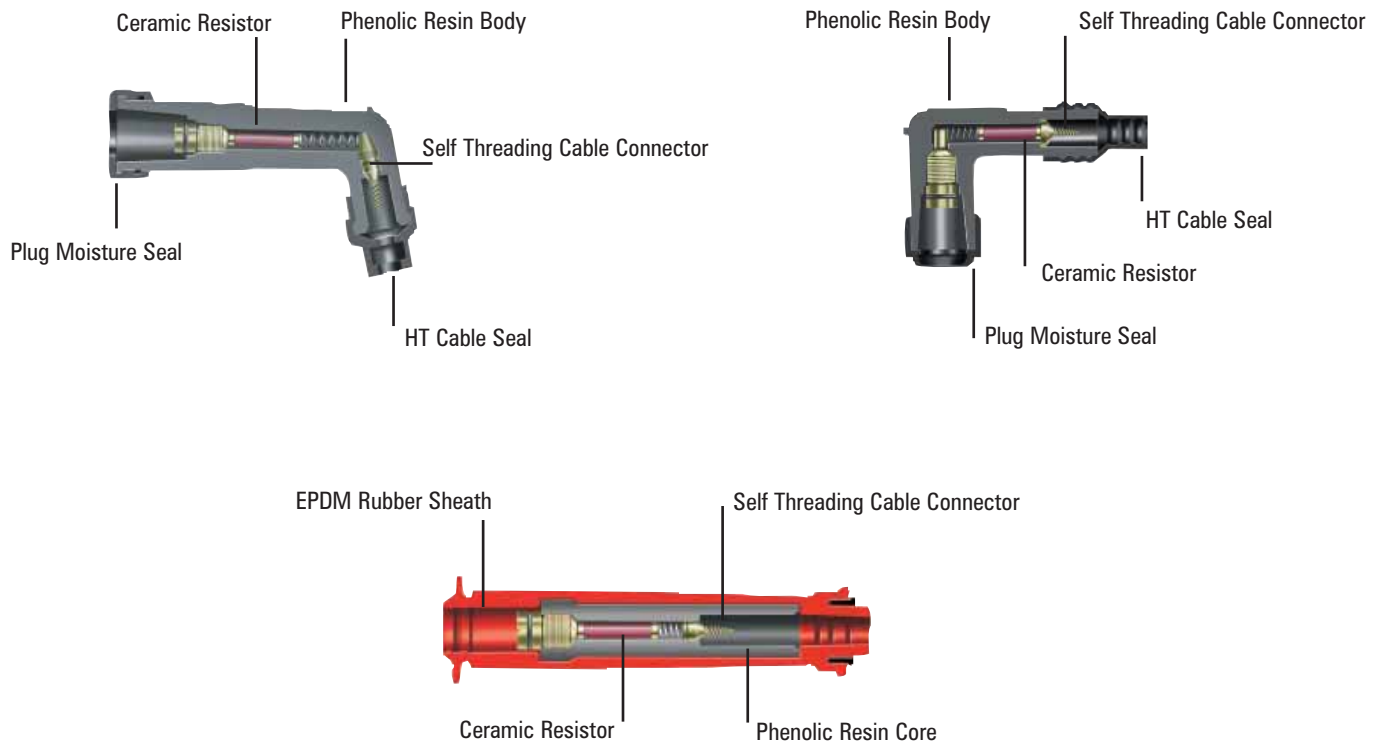

See overleaf for full range of plug covers

SPARK PLUG COVERS

Part No.	Item No.	Colour	Resistor	Ø Plug	Terminal Type
LB05E	8031	Black	5 kΩ	14mm	
LB05E	8898	Red	5 kΩ	14mm	
LB05F	8051	Black	5 kΩ	14mm	
LB05F	8854	Red	5 kΩ	14mm	

Description: 90° Elbow Type Material: Phenolic Resin

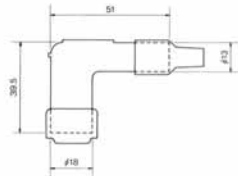

Part No.	Item No.	Colour	Resistor	Ø Plug	Terminal Type
LZFH	8710	Black	None	10 - 14mm	

Description: 90° Non-resistor type Material: Phenolic Resin

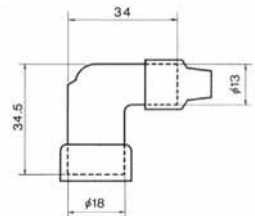

Part No.	Item No.	Colour	Resistor	Ø Plug	Terminal Type
LB05EH	8334	Black	5 kΩ	14mm	
LB05EH	8688	Red	5 kΩ	14mm	
LB10EHF	8055	Black	10 kΩ	14mm	
LB10EHF	8058	Red	10 kΩ	14mm	

Description: 90° Elbow Type Material: Phenolic Resin

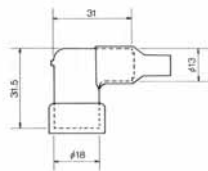

Part No.	Item No.	Colour	Resistor	Ø Plug	Terminal Type
LB05EMH	8338	Black	5 kΩ	14mm	
LB05EMH	8160	Red	5 kΩ	14mm	

Description: 90° Rubber Sheathed Material: EPDM Rubber

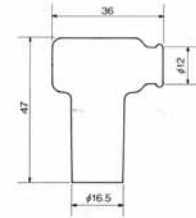

Part No.	Item No.	Colour	Resistor	Ø Plug	Terminal Type
LD05F	8060	Black	5 kΩ	10 - 12mm	
LD05F	8231	Red	5 kΩ	10 - 12mm	

Description: 90° Elbow Type Material: Phenolic Resin

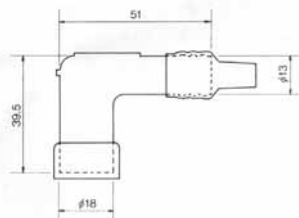

Part No.	Item No.	Colour	Resistor	Ø Plug	Terminal Type
SB05E	8374	Black	5 kΩ	14mm	
SB05E	8511	Red	5 kΩ	14mm	
SB05F	8080	Black	5 kΩ	14mm	
SB05F	8567	Red	5 kΩ	14mm	
SD05F	8022	Black	5 kΩ	10 - 12mm	
SD05F	8238	Red	5 kΩ	10 - 12mm	

Description: Straight Type Material: Phenolic Resin

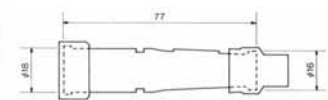

Part No.	Item No.	Colour	Resistor	Ø Plug	Terminal Type
SD05FM	8392	Black	5 kΩ	10 - 12mm	
SD05FM	8673	Red	5 kΩ	10 - 12mm	

Description: Straight Rubber Sheathed Material: EPDM Rubber

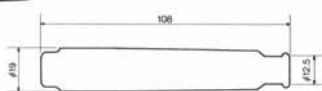

Part No.	Item No.	Colour	Resistor	Ø Plug	Terminal Type
TB05EMA	8636	Black	5 kΩ	14mm	

Description: 90° Rubber Sheathed Material: Silicon Rubber

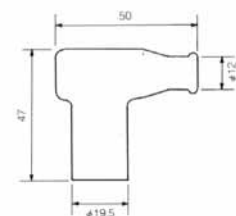

SPARK PLUG COVERS

Part No.	Item No.	Colour	Resistor	Ø Plug	Terminal Type
XB05F	8062	Black	5 kΩ	14mm	
XB05F	8592	Red	5 kΩ	14mm	
XD05F	8072	Black	5 kΩ	10 - 12mm	
XD05F	8768	Red	5 kΩ	10 - 12mm	

Description: 102° Elbow Type Material: Phenolic Resin



Part No.	Item No.	Colour	Resistor	Ø Plug	Terminal Type
VB05F	8032	Black	5 kΩ	14mm	
VB05F	8759	Red	5 kΩ	14mm	
VD05F	8052	Black	5 kΩ	10 - 12mm	
VD05F	8376	Red	5 kΩ	10 - 12mm	



Description: 120° Elbow (Long) Type Material: Phenolic Resin

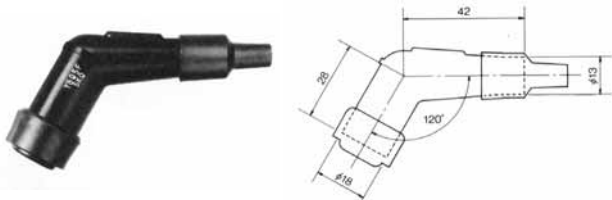

Part No.	Item No.	Colour	Resistor	Ø Plug	Terminal Type
YB05F	8082	Black	5 kΩ	14mm	
YB05F	8162	Red	5 kΩ	14mm	

Description: 120° Elbow (Short) Type Material: Phenolic Resin



Part No.	Item No.	Colour	Resistor	Ø Plug	Terminal Type
LBER	8307	Red	None	14mm	
LBER	8308	Blue	None	14mm	

Description: 90° Rubber Sheathed Material: Silicon Rubber

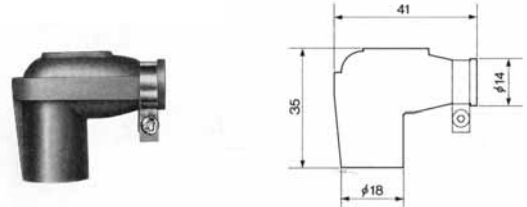

Part No.	Item No.	Colour	Resistor	Ø Plug	Terminal Type
TRS1225	8787	Blue	5 kΩ	14mm	Special*

Description: 90° Compact Type Material: Silicon Rubber

***Suitable for use with R6120-□ racing spark plugs only**
***Suitable for use with R7282-□ racing spark plugs only**

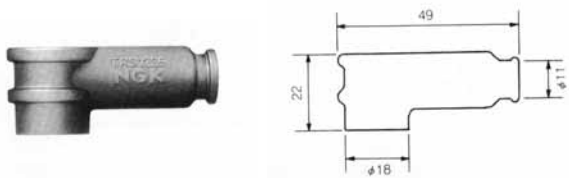

Part No.	Item No.	Colour	Resistor	Ø Plug	Terminal Type
TRS1408F	8871	Blue	5 kΩ	14mm	Special*

Description: 90° Compact Type Material: Silicon Rubber

***Suitable for use with R5300A-□ racing spark plugs only**

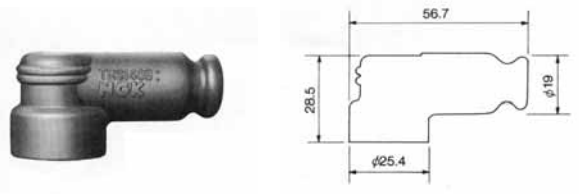

Part No.	Item No.	Colour	Resistor	Ø Plug	Terminal Type
TRS1409	8733	Red	None	14mm	

Description: 90° Compact Type Material: Silicon Rubber

***Suitable for use with R5540F-□ racing spark plugs**



Part No.	Item No.	Colour	Resistor	Ø Plug	Terminal Type
SD05FGA	8683	Black	5 kΩ	10 - 12mm	

Description: Straight with Grommet Material: Phenolic Resin

Application: Honda VT600, XL600



NTK LAMBDA SENSORS FOR MOTORCYCLES

Reducing the pollution created by the internal combustion engine is a great concern for us all. To ensure that manufacturers build cleaner engines the allowable limits for certain polluting gases are set by various government bodies. These limits are getting ever tighter and engine designers are under great pressure to find ways of meeting the targets. A vital part of the pollution control used on many engines is the exhaust gas oxygen sensor - more commonly known as the Lambda sensor. Commonplace on cars since the 1990's, Lambda sensors have been used on motorcycles since 1999 and are now fitted to an increasing number of machines over 125cc.

WHAT DOES THE LAMBDA SENSOR DO?

The most popular method used by vehicle manufacturers to reduce engine emissions is the three-way catalyst (catalytic converter). This device has the ability to take the three main toxic gases produced by an engine which are carbon monoxide (CO), oxides of nitrogen (NO_x) and hydrocarbons (HC) and convert them to considerably less harmful, non-poisonous gases: carbon dioxide (CO₂), water (H₂O) and nitrogen (N₂).

To carry out this conversion of gases efficiently the catalyst must operate within a specified temperature range but also be provided with exhaust gases that are within certain very tight tolerances dependant predominantly on air/fuel ratio. The precise control required to operate this system is provided by the use of an exhaust gas oxygen (Lambda) sensor installed upstream of the catalyst. A Lambda sensor has the ability to precisely measure the residual oxygen present in exhaust gases. By sending a signal to the control unit it can initiate a change to keep the fuelling system operating within the very tight tolerances required. This is known as a closed-loop control system.

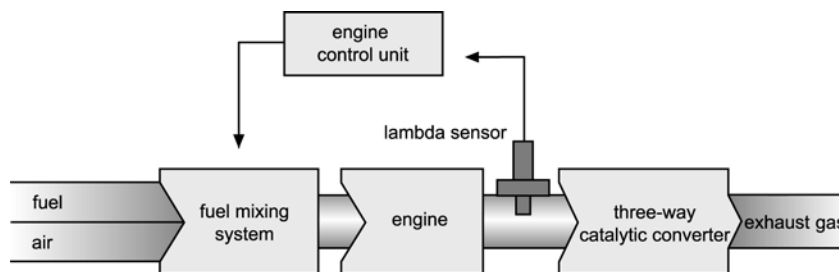

A worn or damaged sensor may affect the bike's general performance, increase fuel consumption, increase unwanted emissions and even damage the catalyst.

TECHNICAL INFORMATION

TORQUE FIGURES

Torque figures and thread form information:
M18 x 1.5mm - 35 ~ 45Nm **M12 x 1.5mm - 18 ~ 23Nm**

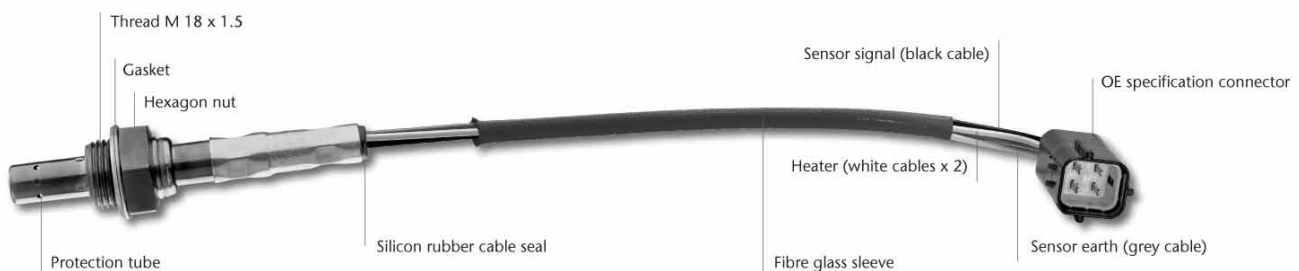

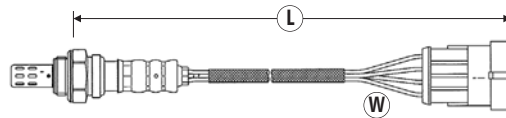

W = Number of Wires
 C = Connector Type (see page 93)
 L = Length of Sensor and Lead (mm)

CC/MODEL	ENGINE	OE-NO.	DATE	W	C	L	NTK PART NO.	STOCK NO.
APRILIA								
1000								
RSV 1000 R	Rotax V2	A2 C 53025886	04.04→	4	31	590	OZA591-SZ1	1767
RSV 1000 R Factory	Rotax V2	A2 C 53025886	10.03→	4	31	590	OZA591-SZ1	1767

BMW								
650								
F650CS		11781 247 406	11.01→12.03	4	68	340	OZA447-E28	0427
F650CS	K14/O2	76 85 320	01.04→12.05	4	68	341	OZA630-BM3	0074
F650GS/GS Dakar		11781 247 406	09.99→12.03	4	68	340	OZA447-E28	0427
F650GS/GS Dakar	R13Mü	76 85 320	12.03→	4	68	341	OZA630-BM3	0074
800								
F800S	K71	76 72 785	12.05→	4	99	521	OZA630-BM2	0073
850								
R850R	R28	76 71 756	07.02→08.05	4	69	922	OZA522-BM1	0053
R850RT	R22	76 71 756	03.01→12.04	4	69	922	OZA522-BM1	0053
1085								
R1100S	259S	76 71 756	01.03→12.03	4	69	922	OZA522-BM1	0053
1150								
R1150GS	R21	76 71 756	11.01→12.03	4	69	922	OZA522-BM1	0053
R1150GS Adventure	R21	76 71 756	11.01→09.06	4	69	922	OZA522-BM1	0053
R1150R	R28	76 71 756	10.02→08.05	4	69	922	OZA522-BM1	0053
R1150RS/RT	R22	76 71 756	03.01→12.04	4	69	922	OZA522-BM1	0053
1170								
HP2 Enduro	K25HP	76 74 452	12.05→	4	99	231	OZA630-BM1	0072
1200								
K1200GT	K41GT	76 71 756	11.02→08.05	4	69	922	OZA522-BM1	0053
K1200GT	K44	76 72 785	12.05→	4	99	521	OZA630-BM2	0073
K1200R	K43	76 72 785	03.05→	4	99	521	OZA630-BM2	0073
K1200S	K40	76 72 785	06.04→	4	99	521	OZA630-BM2	0073
K1200LT	K589	76 71 757	01.04→	4	69	554	OZA522-BM2	0054
K1200RS	K41	76 71 756	01.01→12.04	4	69	922	OZA522-BM1	0053
R1200C/CL	259C/K30	76 71 756	02.02→12.04	4	69	922	OZA522-BM1	0053
R1200GS	K25	76 74 452	11.03→	4	99	231	OZA630-BM1	0072
R1200RT	K26	76 74 452	10.04→	4	99	231	OZA630-BM1	0072
R1200S	K29	76 74 452	10.05→	4	99	231	OZA630-BM1	0072
R1200ST	K28	76 74 452	12.04→	4	99	231	OZA630-BM1	0072

DUCATI								
695								
Monster 695		CA.0083 476	06.04→	4	40	880	OZA591-BB3	0066
992								
GT 1000		CA.0083 476	01.06→	4	40	880	OZA591-BB3	0066
Monster S2R 1000		CA.0083 476	01.06→	4	40	880	OZA591-BB3	0066
Paul Smart 1000		CA.0083 476	01.06→	4	40	880	OZA591-BB3	0066
ST3, ST3S		CA.0083 476	01.04→	4	40	880	OZA591-BB3	0066
Sport 1000		CA.0083 476	01.06→	4	40	880	OZA591-BB3	0066
998								
Monster S4RS		CA.0083 476	06.04→	4	40	880	OZA591-BB3	0066

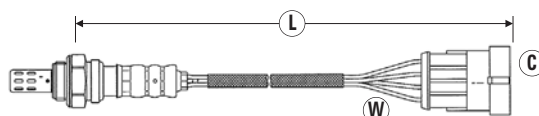

W = Number of Wires
C = Connector Type (see page 93)
L = Length of Sensor and Lead (mm)

CC/MODEL	ENGINE	OE-NO.	DATE	W	C	L	NTK PART NO.	STOCK NO.
HONDA								
125								
FES125 Pantheon		36531-KRJ-9010-M1	01.05→	4	96	280	OZA577-H6	0065
PS125i		36531-KTF-6410-M1	01.06→	4	96	210	OZA577-H15	0064
SH125i		36531-KTF-6410-M1	01.05→	4	96	210	OZA577-H15	0064
150								
Pantheon 150i		36531-KRJ-9010-M1	01.05→	4	96	280	OZA577-H6	0065
1000								
CBF1000		36531-MFAA-D001-M1	01.06→	4	80	990	OZA577-H17	0007





KTM								
999								
990 Adventure / S		1614 833 0000	01.06→	4	97	500	OZA591-VB2	0009
990 Superduke		1614 833 0000	01.06→	4	97	500	OZA591-VB2	0009

MOTO GUZZI								
750								
Breva V750 i.e.		CA.0019 265	01.03→	4	40	310	OZA341-BB1	0036
1100								
Breva V 1100		CA.0019 265	03.04→	4	40	310	OZA341-BB1	0036
California		CA.0019 265	03.04→	4	40	310	OZA341-BB1	0036
V11 Models		CA.0019 265	03.04→12.05	4	40	310	OZA341-BB1	0036

SUZUKI								
600								
GSX-R600		18213-01H00	03.06→	4	80	690	OZA448-J4	0003
750								
GSX-R750		18213-01H00	03.06→	4	80	690	OZA448-J4	0003
1800								
VZR1800 K6 (M1800R Intruder)		18213-48G00	04.06→	4	80	370	OZA448-J5	0004

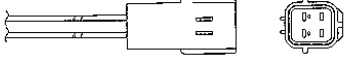
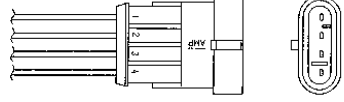
TRIUMPH								
600								
Daytona 600		22 01 347	01.03→12.05	4	97	640	OZA591-UB1	0067
Speed Four		22 01 347	01.02→	4	97	640	OZA591-UB1	0067
885								
Thunderbird Sport		22 01 347	01.03→12.04	4	97	640	OZA591-UB1	0067
995								
Daytona 955i		22 01 347	01.01→	4	97	640	OZA591-UB1	0067
Speed Triple		22 01 347	01.01→12.05	4	97	640	OZA591-UB1	0067
Sprint RS		22 01 347	01.01→12.04	4	97	640	OZA591-UB1	0067
Sprint ST		22 01 347	01.01→12.04	4	97	640	OZA591-UB1	0067
Tiger		22 01 347	01.03→	4	97	640	OZA591-UB1	0067
1050								
Sprint ST		22 01 347	01.05→	4	97	640	OZA591-UB1	0067
Speed Triple		22 01 347	01.06→	4	97	640	OZA591-UB1	0067
2300								
Rocket III		22 01 247	01.04→	4	97	535	OZA591-UB2	0008
Rocket III Classic		22 01 247	01.06	4	97	535	OZA591-UB2	0008

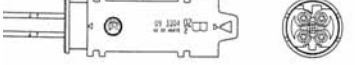
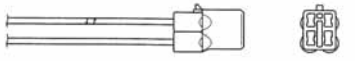
CONNECTOR TYPES

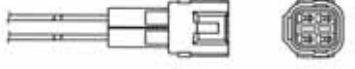
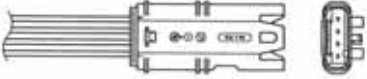
	Application	Order
31 	OZA591-SZ1	1767
40 	OZA341-BB1	0036
68 	OZA447-E28	0427
	OZA630-BM3	0074
69 	OZA522-BM1	0053
	OZA522-BM2	0054
80 	OZA448-J4	0003
	OZA448-J5	0004
	OZA577-H17	0007
96 	OZA577-H15	0064
	OZA577-H6	0065
97 	OZA591-UB1	0067
	OZA591-UB2	0008
	OZA591-VB2	0009
99 	OZA630-BM2	0073

NOTES

www.ngkntk.co.uk



Bikers won't fit anything else



Around the world bikers and bike manufacturers agree that when it comes to spark plugs, one plug is king. NGK. Which is why they are the world's No.1 OE fitment. So don't try fitting anything else.

You have been warned.

Original Equipment suppliers to:- Aprilia Armstrong BMW CCM Cagiva Derbi Ducati Gas Gas Honda Husqvarna India Kawasaki KTM Moto Guzzi Norton Peugeot Polaris Royal Enfield Scorpa Suzuki SMC TGB Triumph Victory Yamaha



The World's No.1 Spark Plug



OE

Fitted as Original Equipment by:

Aprilia Armstrong BMW CCM Cagiva
Derbi Ducati Gas Gas Honda Husqvarna
Indian Kawasaki KTM Moto Guzzi Norton
Peugeot Polaris Royal Enfield Scorpa
Suzuki SMC TGB Triumph Victory Yamaha

NGK Spark Plugs (UK) Limited
Maylands Avenue Hemel Hempstead
Herts HP2 4SD
Tel: 01442 281000
Fax: 01442 281001
www.ngkntk.co.uk